



## BASIC MANUAL

# VHF/UHF TRANSCEIVER ID-51A ID-51E

This device complies with Part 15 of the FCC Rules. Operation is subject to the following two conditions: (1) this device may not cause harmful interference, and (2) this device must accept any interference received, including interference that may cause undesired operation.

**WARNING:** MODIFICATION OF THIS DEVICE TO RECEIVE CELLULAR RADIOTELEPHONE SERVICE SIGNALS IS PROHIBITED UNDER FCC RULES AND FEDERAL LAW.

**Icom Inc.**



The photo shows the ID-51E version.

---

Thank you for choosing this Icom product. This product is designed and built with Icom's state of the art technology and craftsmanship. With proper care, this product should provide you with years of trouble-free operation.

This product combines traditional analog technologies with the new digital technology, Digital Smart Technologies for Amateur Radio (D-STAR), for a balanced package.

Icom, Icom Inc. and the Icom logo are registered trademarks of Icom Incorporated (Japan) in Japan, the United States, the United Kingdom, Germany, France, Spain, Russia, Australia, New Zealand, and/or other countries.

Adobe, Acrobat, and Reader are either registered trademarks or trademarks of Adobe Systems Incorporated in the United States and/or other countries.

Microsoft, Windows and Windows Vista are registered trademarks of Microsoft Corporation in the United States and/or other countries.

---

## FEATURES

---

- *The dualwatch function simultaneously monitors VHF/VHF, UHF/UHF and VHF/UHF bands\*.*

*Two band monitoring plus the Broadcast (BC) Radio.*

*\*DV/DV, AM/AM, FM-N/FM-N and DV/FM-N mode dualwatch is not available.*

- *Rapid charging is possible, and the charging time period is approximately 3 hours with the supplied battery pack.*
- *Built-in GPS receiver allows you to check your current position, or automatically send a reply with your position to the caller station.*
- *Voice recorder records your QSO conversation, voice audio for TX and microphone voice audio.*
- *The microSD card slot that can accept different cards to backup settings, various memories, the GPS log and so on.*

## EXPLICIT DEFINITIONS

WORD	DEFINITION
<b>⚠ DANGER!</b>	Personal death, serious injury or an explosion may occur.
<b>⚠ WARNING!</b>	Personal injury, fire hazard or electric shock may occur.
<b>CAUTION</b>	Equipment damage may occur.
<b>NOTE</b>	Recommended for optimum use. No risk of personal injury, fire or electric shock.

## IMPORTANT

**READ ALL INSTRUCTIONS** carefully and completely before using the transceiver.

**SAVE THIS INSTRUCTION MANUAL**— This instruction manual contains basic operating instructions for the ID-51A/ID-51E.

For Advanced features and instructions, open the Advanced manual that is on the supplied CD.

## SUPPLIED ACCESSORIES

The following accessories are supplied with the transceiver.

Antenna



Hand strap



Battery charger  
(BC-167SA/SD/SV)\*1

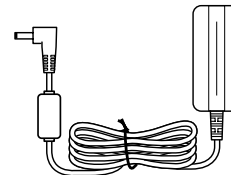

Belt clip

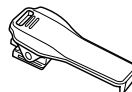

Battery pack  
(BP-271)

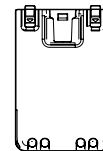

CD\*2

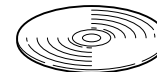

\*1 Not supplied, or the shape is different, depending on the transceiver version.

\*2 Includes the CS-51PLUS2 CLONING SOFTWARE

# ABOUT THE SUPPLIED CD

The following manuals and installers are included on the CD. See the PDF type Advanced manual or “About the DV Gateway function” that can be downloaded from the Icom website for the functions that are not described on this manual.

## • Basic manual

Instructions for the basic operations, the same as this manual

## • Advanced manual

Instructions for the advanced operations and more details than are described in this manual

## • HAM radio Terms

A glossary of HAM radio terms

## • CS-51PLUS2 Instruction manual

Instructions for the CS-51PLUS2 cloning software installation and use

## • CS-51PLUS2 Installer

Installer for the CS-51PLUS2 cloning software

## • Adobe® Acrobat® Reader® Installer

Installer for Adobe® Acrobat® Reader®

A PC with the following Operating System is required.

- Microsoft® Windows® 10, Microsoft® Windows® 8.1, Microsoft® Windows® 7, or Microsoft® Windows Vista®.

To read the guide or instructions, Adobe® Acrobat® Reader® is required. If you have not installed it, please install the Adobe® Acrobat® Reader® on the CD or downloaded it from Adobe Systems Incorporated's website.

## ◇ Starting the CD

- ① Insert the CD into the CD drive.
  - Double click “Menu.exe” on the CD.
  - Depending on the PC setting, the Menu screen shown below may be automatically displayed.
- ② Click the appropriate file button to open it.
  - To close the Menu screen, click [Quit].

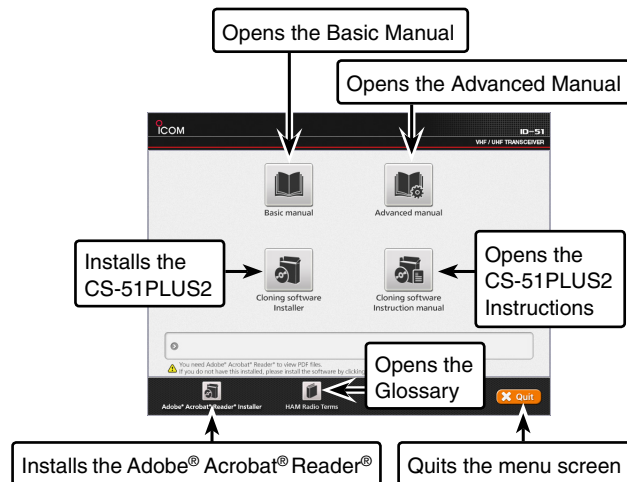

---

## IMPORTANT NOTES

---

### ◇ When using the GPS receiver

- GPS signals cannot pass through metal objects. When using the ID-51A or ID-51E inside a vehicle, you may not receive GPS signals. We recommend you use it near a window.
- The Global Positioning System (GPS) is built and operated by the U.S. Department of Defence. The Department is responsible for accuracy and maintenance of the system. Any changes by the Department may affect the accuracy and function of the GPS system.
- When the GPS receiver is activated, please do not cover the ID-51A or ID-51E with anything that will block the satellite signals.
- The GPS receiver may not work if used in the following locations:
  1. Tunnels or high-rise buildings
  2. Underground parking lots
  3. Under a bridge or viaduct
  4. In remote forested areas
  5. Under bad weather conditions (rainy or cloudy day)
- The GPS receiver may not work if the transceiver operates near the 440.205 MHz. This is due to signals made in the internal circuit and does not indicate a transceiver malfunction.

### ◇ Spurious signals

Depending on the combination of the operating band and mode, the Dualwatch or monitoring Two Ham bands plus the Broadcast (BC) radio may generate certain spurious signals, or noise may be heard. These do not indicate a transceiver malfunction.

### ◇ About charging with the power ON

ID-51A/E's charging circuit can charge the supplied battery pack in approximately 3 hours. But with this rapid circuit, the battery pack cannot be charged with the power ON, by default. So, be sure to turn OFF the power before charging. When "Charging (Power ON)"\* is set to ON in the MENU screen, the battery pack can be charged even if the power is ON. (Only when the battery pack is attached, and the optional CP-12L, CP-19R or OPC-254L external DC power cable is connected to [DC IN].) But this operation may generate certain spurious signals, and the S-meter may appear, or noise may be heard. \*MENU > Function > **Charging (Power ON)** (Default: OFF)

- The charging time period with the power ON may differ, depending on the operating condition.
- The external DC power supply voltage must be between 10 ~ 16 V, and the current capacity must be more than 2.5 A to charge the battery pack with the power ON.
- When you operate the transceiver while charging, and if you cannot receive signals correctly, set "Charging (Power ON)"\* to OFF, and disconnect the external DC power cable from [DC IN].
- When the supply voltage exceeds 14 V, the built-in protection circuit activates to reduce the transmit output power to approximately 2.5 W.

---

## PRECAUTIONS

---

⚠ **DANGER! NEVER** short the terminals of the battery pack. Shorting may occur if the terminals touch metal objects such as a key, so be careful when placing the battery packs (or the transceiver) in bags, and so on. Carry them so that shorting cannot occur with metal objects. Shorting may damage not only the battery pack, but also the transceiver.

⚠ **DANGER! NEVER** use and charge Icom battery packs with non-Icom transceivers or non-Icom chargers. Only Icom battery packs are tested and approved for use with Icom transceivers or charged with Icom chargers. Using third-party or counterfeit battery packs or chargers may cause smoke, fire, or cause the battery to burst.

⚠ **DANGER! NEVER** operate the transceiver near unshielded electrical blasting caps or in an explosive atmosphere. This could cause an explosion and death.

⚠ **WARNING RF EXPOSURE!** This device emits Radio Frequency (RF) energy. Caution should be observed when operating this device. If you have any questions regarding RF exposure and safety standards, please refer to the Federal Communications Commission Office of Engineering and Technology's report on Evaluating Compliance with FCC Guidelines for Human Radio Frequency Electromagnetic Fields (OET Bulletin 65).

⚠ **WARNING! NEVER** hold the transceiver so that the antenna is very close to, or touching exposed parts of the body, especially the face or eyes, while transmitting. The transceiver will perform best if the microphone is 5 to 10 cm (2 to 4 inches) away from the lips and the transceiver is vertical.

⚠ **WARNING! NEVER** operate or touch the transceiver with wet hands. This could cause an electric shock or damage the transceiver.

⚠ **WARNING! NEVER** operate the transceiver with an earphone, headphones or other audio accessories at high volume levels. If you experience a ringing in your ears, reduce the volume or discontinue use.

⚠ **WARNING! NEVER** connect the transceiver to a power source of more than 16 V DC or use reverse polarity. This could cause a fire or damage the transceiver.

**CAUTION: DO NOT** operate the transceiver unless the flexible antenna, battery pack and jack cover are securely attached. Confirm that the antenna and battery pack are dry before attaching. Exposing the inside of the transceiver to dust or water can cause serious damage to the transceiver. After exposure to water, clean the battery contacts thoroughly with fresh water and dry them completely to remove any water or salt residue.

---

## PRECAUTIONS

---

**CAUTION: DO NOT** operate the transceiver while driving a vehicle. Safe driving requires your full attention—anything less may result in an accident.

**DO NOT** use harsh solvents such as Benzine or alcohol when cleaning, because they will damage the transceiver surfaces.

**DO NOT** push [PTT] when you do not actually intend to transmit.

**DO NOT** place or leave the transceiver in direct sunlight or in areas with temperatures below  $-20^{\circ}\text{C}$  ( $-4^{\circ}\text{F}$ ) or above  $+60^{\circ}\text{C}$  ( $+140^{\circ}\text{F}$ ).

**BE CAREFUL!** The transceiver will become hot when operating it continuously for long periods of time.

**BE CAREFUL!** The transceiver meets IPX7\* requirements for waterproof protection. However, once the transceiver has been dropped, waterproof protection cannot be guaranteed because of possible damage to the transceiver's case or waterproof seal.

\* Only when the BP-271 or BP-272 (option), flexible antenna, [MIC/SP] cap, [DATA/DC IN] cap and [micro SD] slot cap are attached.

Place the transceiver in a secure place to avoid inadvertent use by unauthorized persons.

When the BP-273 is connected to the transceiver, it meets IPX4 requirements for splash resistance.

When it is connected, the transceiver corresponds to IPX4.

Even when the transceiver power is OFF, a slight current still flows in the circuits. Remove the battery pack or batteries from the transceiver when not using it for a long time. Otherwise, the installed battery pack or batteries will become exhausted, and will need to be recharged or replaced.

---

# BATTERY CAUTIONS

---

## ◇ Battery caution

⚠ **DANGER! NEVER** strike or otherwise impact the battery pack. Do not use the pack if it has been severely impacted or dropped, or if it has been subjected to heavy pressure. Battery damage may not be visible on the outside of the case. Even if the surface of the pack does not show cracks or any other damage, the cells inside the pack may rupture or catch fire.

⚠ **DANGER! NEVER** leave the battery pack in places with temperatures above +60°C (+140°F). High temperature buildup in the battery cells, such as could occur near fires or stoves, inside a sun-heated vehicle, or in direct sunlight for long periods of time may cause the battery cells to rupture or catch fire. Excessive temperatures may also degrade pack's performance or shorten the battery cell's life.

⚠ **DANGER! NEVER** expose the battery pack to rain, snow, seawater, or any other liquids. Do not charge or use a wet battery pack. If the pack gets wet, be sure to wipe it dry before using.

⚠ **DANGER! NEVER** place battery packs near a fire. Fire or heat may cause them to rupture or explode. Dispose of used packs in accordance with local regulations.

⚠ **DANGER! NEVER** solder the battery cell's terminals, and **NEVER** modify the battery pack. This may cause heat generation, and the battery cells may burst, emit smoke or catch fire.

⚠ **DANGER! NEVER** use the battery pack with a transceiver for which it is not specified. **NEVER** use a pack with any other equipment, or for any purpose that is not specified in this instruction manual.

⚠ **DANGER! NEVER** let fluid from inside the battery cells get in your eyes. If it does, blindness can result. Rinse your eyes with clean water, without rubbing them, and immediately go to a doctor.

⚠ **WARNING! NEVER** use the battery pack if it emits an abnormal odor, heats up, or is discolored or deformed. If any of these conditions occur, contact your Icom dealer or distributor.

⚠ **WARNING! NEVER** let fluid from inside the battery cells come in contact with your body. If it does, immediately wash with clean water.

⚠ **WARNING! NEVER** put the battery pack in a microwave oven, high-pressure container, or in an induction heating cooker. This could cause a fire, overheating, or cause the battery cells to rupture.

**CAUTION: DO NOT** use the battery pack out of the specified temperature range -20°C to +60°C (-4°F to +140°F). Using the pack out of its specified temperature range will reduce its performance and the battery cell's life.

**CAUTION: DO NOT** leave the pack fully charged, completely discharged, or in an excessive temperature environment (above +50°C, +122°F) for an extended period of time. Otherwise a shorter battery pack life could occur. If the battery pack must be left unused for a long time, it must be detached from the transceiver after discharging. You may use the pack until the remaining capacity is about half, then keep it safely in a cool dry place in the following temperature range:

- |                                |                        |
|--------------------------------|------------------------|
| -20°C (-4°F) to +50°C (+122°F) | (within a month).      |
| -20°C (-4°F) to +35°C (+95°F)  | (within three months). |
| -20°C (-4°F) to +20°C (+68°F)  | (within a year).       |



---

## BATTERY CAUTIONS

---

**BE SURE** to replace the battery pack with a new one approximately five years after manufacturing, even if it still holds a charge. The material inside the battery cells will become weak after a period of time, even with little use. The estimated number of times you can charge the pack is between 300 and 500. Even when the pack appears to be fully charged, the operating time of the transceiver may become short when:

- Approximately five years have passed since the pack was manufactured.
- The pack has been repeatedly charged.

### ◇ Charging caution

⚠ **DANGER! NEVER** charge the battery pack in areas with extremely high temperatures, such as near fires or stoves, inside a sun-heated vehicle, or in direct sunlight. In such environments, the safety/protection circuit in the pack will activate and stop the charging.

⚠ **DANGER! NEVER** charge the transceiver during a lightning storm. It may result in an electric shock, cause a fire or damage the transceiver. Always disconnect the power adapter before a storm.

⚠ **WARNING! NEVER** charge or leave the battery pack in the battery charger beyond the specified time for charging. If the pack is not completely charged by the specified time, stop charging and remove it from the battery charger. Continuing to charge the pack beyond the specified time limit may cause a fire, overheating, or the battery cells may rupture.

⚠ **WARNING! NEVER** insert the transceiver (with the battery pack attached) into the charger if it is wet or soiled. This could corrode the battery charger terminals or damage the charger. The charger is not waterproof.

**CAUTION: DO NOT** charge the battery pack outside of the specified temperature range: 0°C to +40°C (+32°F to +104°F). Icom recommends charging the pack at +25°C (+77°F). The pack may heat up or rupture if charged out of the specified temperature range. Additionally, battery performance or battery life may be reduced.

**BE SURE** to turn the transceiver power OFF while charging with the supplied or optional charger (BC-167S/BC-202). The battery pack cannot be charged with the charger when the transceiver's power is ON.

### ◇ Charging time

Charger Battery pack	BC-167S (Supplied)	BC-202 (Optional)
BP-271 (Supplied)	Approx. 3 hours	Approx. 2 hours
BP-272 (Optional)	Approx. 4.5 hours	Approx. 3.5 hours

---

# TABLE OF CONTENTS

---

FEATURES.....	i
EXPLICIT DEFINITIONS.....	ii
IMPORTANT.....	ii
SUPPLIED ACCESSORIES.....	ii
ABOUT THE SUPPLIED CD.....	iii
IMPORTANT NOTES.....	iv
PRECAUTIONS.....	v
BATTERY CAUTIONS.....	vii

## UNIQUE FUNCTIONS..... xi–xiii

1 QSO Recording function.....	xi
2 Auto Position Reply function.....	xi
3 Voice TX function.....	xi
4 Near FM Repeater search function.....	xii
5 DV Fast data mode.....	xii
6 Add-on functions for D-PRS.....	xii
7 Connecting an Android™ device.....	xii
8 DV Gateway function.....	xiii

## 1 PANEL DESCRIPTION..... 1–9

■ Front, top and side panels.....	1
■ Function display.....	6

## 2 STARTING INITIAL SETUP..... 10–19

■ Attaching the Battery pack.....	10
■ Charging the battery pack.....	11
■ Inserting the microSD card.....	11
■ Power ON.....	12
■ Setting audio volume.....	12
■ Setting Date/Time.....	12
■ Enter your call sign into the transceiver.....	14
■ Register your call sign at a gateway repeater.....	16
■ Save setting data onto a microSD card (Recommend)..	18

## 3 MENU SCREEN..... 20–32

■ Menu item selection.....	19
■ Menu items and their details.....	21

## 4 BASIC OPERATION..... 32–41

■ Receiving.....	32
■ Dualwatch operation.....	32
■ Selecting the operating band.....	34
■ Selecting a tuning step.....	34
■ Selecting the operating mode.....	35
■ Setting a frequency.....	35
■ Setting the squelch level.....	36
■ Monitor function.....	36
■ Selecting the Mode and the DR function.....	37

---

# TABLE OF CONTENTS

---

■ Key Lock function.....	38
■ Transmitting.....	39
■ BC Radio operation.....	41
<b>5 MEMORY CHANNEL OPERATION.....</b>	<b>42–43</b>
■ Memory channel programming.....	42
■ Selecting the Memory channel.....	43
<b>6 D-STAR OPERATION.....</b>	<b>44–72</b>
■ Unique features of D-STAR.....	44
■ D-STAR Introduction.....	45
■ About the DR (D-STAR Repeater) function.....	45
■ Ways to Communicate with the DR function.....	46
■ Making a Simplex call with the DR function.....	47
■ Accessing repeaters.....	48
■ Using the RX history.....	51
■ Capturing a call sign.....	55
■ Making a Local area call.....	56
■ Making a Gateway Repeater call.....	58
■ Calling an individual station.....	59
■ Troubleshooting.....	61
■ Reflector operation.....	63
■ Updating the repeater list.....	69
<b>7 RECORDING A QSO     ONTO A microSD CARD.....</b>	<b>73–77</b>
■ About the microSD card.....	73
■ Recording a QSO audio.....	74
■ Playing recorded audio.....	75
■ Removing the microSD card.....	76
<b>8 GPS OPERATION.....</b>	<b>78–80</b>
■ GPS operation.....	78
■ Checking your GPS position.....	78
■ GPS Logger function.....	80
<b>9 RESETTING.....</b>	<b>81</b>
■ Resetting.....	81
<b>10 INFORMATION.....</b>	<b>82</b>
COUNTRY CODE LIST.....	82
FCC INFORMATION.....	82
<b>INDEX.....</b>	<b>83–85</b>
<b>INDEX FOR MENU ITEMS.....</b>	<b>86–89</b>
<b>SPECIFICATIONS.....</b>	<b>90–91</b>

# UNIQUE FUNCTIONS

This section introduces unique functions built into the ID-51A/E.

- See the PDF type Advanced manual or “About the DV Gateway function” that can be downloaded from the Icom website for more details.

## 1 QSO Recording function

You can record the MAIN band QSO audio.

You can record only the receive audio or both the transmit and receive audio.

You can also store and view the QSO/RX log file.

- The log file stores following contents:

RX Frequency, Operating mode (DV is fixed), Call sign of the caller station, Note after the call sign, Call sign of the called station, Access repeater call sign of the caller station or the gateway repeater call sign of your local area repeater, Access repeater call sign of the called station, Message included in the received call (up to 20 characters).

- See page 73 or the PDF type Advanced manual's Section 11 for details.

**NOTE:** This function requires a microSD card.

## 2 Auto Position Reply function

When you receive a call addressed to your own call sign, but are in a situation that makes it difficult to operate the transceiver, this function automatically replies with your own call sign and transmits your position.

- See the PDF type Advanced manual's Section 9 for details.

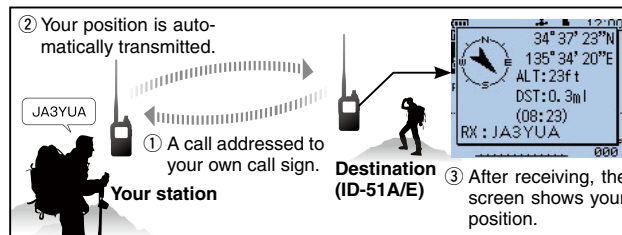

## 3 Voice TX function

You can transmit recorded audio once or repeatedly, which is useful for D-STAR events.

- See the PDF type Advanced manual's Section 17 for details.

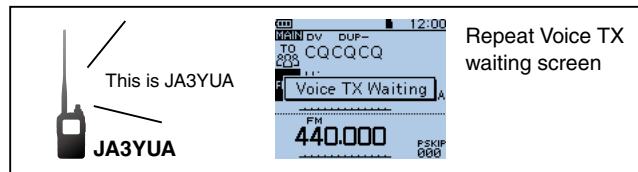

**NOTE:** This function requires a microSD card.

#### 4 Near FM Repeater search function

You can select FM repeaters using the DR function.

The function can find only FM repeaters in your transceiver's repeater list.

- See the PDF type Advanced manual's Section 6 for details.

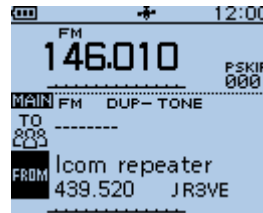

When FM repeater is selected.

#### 5 DV Fast data mode

In addition to low-speed data communication, you can send high-speed data using the DV Fast data mode.

The data speed of the DV Fast data mode is approximately 3480 bps, and is 3.5 times faster than the low-speed data communication mode (approximately 950 bps).

- See the PDF type Advanced manual's Section 9 for details.

#### 6 Add-on functions for D-PRS

D-PRS enables the transceiver to receive the Object, Item or Weather data in addition to position data.

With the D-PRS add-on functions, you can receive information such as an event, traffic, emergency or weather while making a voice call in the DV mode.

- See the PDF type Advanced manual's Section 10 for details.

#### 7 Connecting an Android™ device

You can connect a third party Android™ device through the optional OPC-2350LU DATA CABLE.

When you connect an Android™ device to the transceiver, you can use the extended D-STAR functions with the RS-MS1A\*, such as remote control operation or sending messages and/or pictures.

\*The RS-MS1A is a freeware Android™ application.

- See the PDF type Advanced manual's Section 18 for details.

## UNIQUE FUNCTIONS

### 8 DV Gateway function

Even if you cannot access a D-STAR repeater, you can make a Gateway call through the internet by connecting the optional OPC-2350LU DATA CABLE to a PC (Windows®) or Android® device.

**NOTE:** A Global IP connection is necessary for PC (Windows®) or Android® device.

See “About the DV Gateway function” on the Icom WEB site, <http://www.icom.co.jp/world/> for details.

Enter ‘ID-51’ into the Search box in the site.

Before you set up the access point, check any regulations or laws in your country.

#### Terminal mode

The Terminal mode enables you to make a Gateway call through the internet by connecting the optional OPC-2350LU to a PC (Windows®) or Android® device.

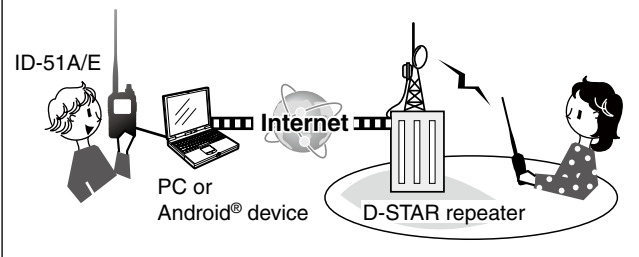

#### Access Point mode

The Access Point mode enables the D-STAR transceiver to make a Gateway call through an ID-51A/E by connecting the optional OPC-2350LU to a PC (Windows®) or Android® device.

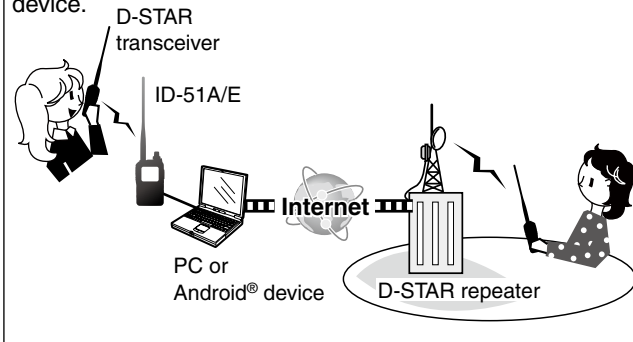

## ■ Front, top and side panels

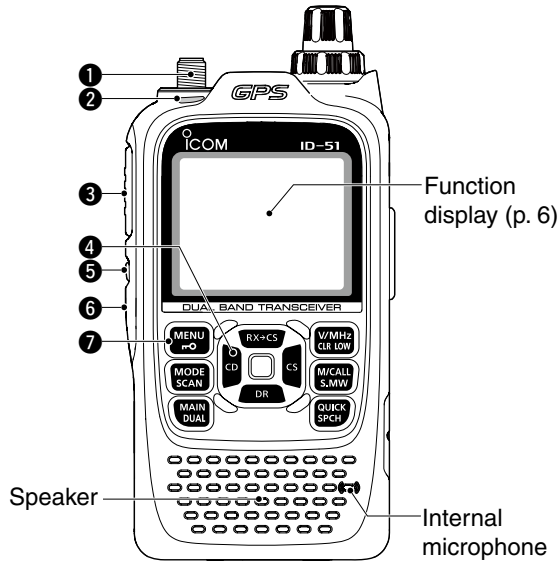

### 1 ANTENNA CONNECTOR

Connect the antenna here.

- The optional AD-92SMA adapter connects an antenna with a BNC connector.

### 2 TX/RX INDICATOR [TX/RX] (p. 39)

Lights red while transmitting, lights green while receiving a signal or when the squelch is open.

### 3 PTT SWITCH [PTT] (p. 39)

Hold down to transmit, release to receive.

#### *For ID-51E only*

Push briefly and release, then hold down to transmit a 1750 Hz tone burst.

### 4 CD (RX CALL SIGN DISPLAY)/D-PAD (LEFT) KEY [CD]/D-pad(←)

➤ While in the DV mode, hold down for 1 second to open the received calls record. (p. 52)

➤ While in the DR screen, or with the Menu screen or Quick Menu screen open, push to select an upper tier menu.



### 5 SQUELCH KEY [SQL]

➤ Hold down to temporarily open the squelch and monitor the operating frequency.

➤ While holding down this key, rotate [DIAL] to adjust the squelch level. (p. 36)

### 6 POWER KEY [⏻]

Hold down for 1 second to turn the transceiver power ON or OFF. (p. 12)

### 7 MENU • LOCK KEY [MENU ↵]

➤ Push to enter or exit the Menu screen. (p. 20)

➤ Hold down for 1 second to toggle the Key Lock function ON or OFF. (p. 38)



# 1 PANEL DESCRIPTION

## ■ Front, top and side panels (Continued)

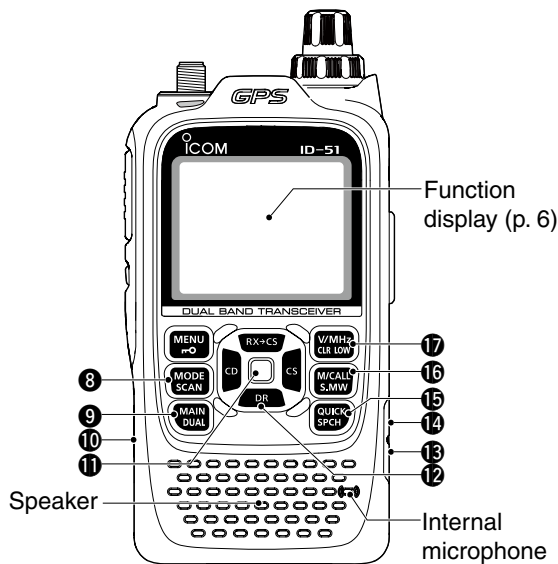

### 8 MODE • SCAN KEY [MODE•SCAN]



- ➔ Push to select the operating mode. (p. 35)
  - Selectable operating modes are AM, FM, FM-N and DV.
- ➔ Hold down for 1 second to enter the scan type selection mode.
  - Push again to start the scan.
  - Push  to stop the scan.

### 9 MAIN • DUAL KEY [MAIN•DUAL]



- ➔ Push to toggle the main band between A and B bands. (p. 33)
- ➔ Hold down for 1 second to toggle the Dualwatch function ON or OFF. (p. 33)

### 10 microSD CARD SLOT [microSD]

Insert a microSD card of up to 32 GB.

### 11 ENTER KEY [ENT]

When the DR set screen, Menu screen or Quick Menu screen is displayed, push to set the selected item or option.

### 12 DR (D-STAR REPEATER)/D-PAD (DOWN) KEY [DR]/D-pad(↓)



- ➔ Hold down for 1 second to display the DR screen.
- ➔ While in the DR screen, or with the Menu screen or Quick Menu screen open, push to move the value or option selector bar down.



**13 EXTERNAL DC IN JACK [DC IN]**

- ➔ Connects to the supplied battery charger (BC-167SA/SD/SV), to charge the attached battery pack. (p. 11)
- ➔ Connect an external DC power source through the optional CP-12L or CP-19R cigarette lighter cable or OPC-254L DC power cable for external DC operation.

**14 DATA JACK [DATA]**

Connects to a PC through the optional data communication cable, for data communication in the DV mode, or for cloning. The jack is also used to connect an external GPS receiver.

**15 QUICK MENU • SPEECH KEY [QUICK SPCH]**



- ➔ Push to enter or exit the Quick Menu screen. (p. 5)
  - The Quick Menu is used to quickly select various functions.
- ➔ Hold down for 1 second to audibly announce the displayed frequency, operating mode or call sign.

**16 MEMORY/CALL • SELECT MEMORY WRITE KEY [M/CALL•S.MW]**



- ➔ In the VFO mode, push once to enter the Memory selection mode, push again to enter the Call channel mode. (p. 37)
  - For ID-51A only**
  - In the Call channel mode, push once to enter the Weather channel mode.
- ➔ Hold down for 1 second to enter the Select Memory Write mode. (p. 42)

**17 VFO/MHz • CLEAR • OUTPUT POWER KEY [VFO/MHz•CLR•LOW]**



- ➔ Push to select the VFO mode. (p. 37)
- ➔ While in the VFO mode, push to select 1 MHz or 10 MHz tuning steps. (p. 35)
- ➔ With the Menu screen or Quick Menu screen open, push to return to the operating mode before displaying the Menu screen.
- ➔ While in the Memory Name or Call Sign Programming mode, push to delete a character. (p. 14)
- ➔ While scanning, push to cancel a scan.
- ➔ Hold down for 1 second to select the output power. (p. 39)
  - Select the transmit output power of High, Mid, Low2, Low1 or S-low.
  - While holding down this key, rotate [DIAL] to select the desired output power.

# 1 PANEL DESCRIPTION

## ■ Front, top and side panels (Continued)



### 18 CS (CALL SIGN SELECT)/D-PAD (RIGHT) KEY [CS]/D-pad(→)



- Hold down for 1 second to enter the operating call sign select mode.
- While in the DR screen, or with the Menu screen or Quick Menu screen open, push to select a lower tier menu.

### 19 RX→CS (RX CALL SIGN CAPTURE)/D-PAD (UP) KEY [RX→CS]/D-pad(↑)



- While in the DV mode, hold down for 1 second to display the RX History list.  
When "[RX->CS] Key" item is set to "Call Sign Capture," the latest received call signs (station and repeaters) is set as the operating call signs after releasing this key. (p. 55)
  - While holding down this key, rotate [DIAL] to select another call sign in RX History.
- When "[RX->CS] Key" item is set to "RX->CS List," you can select a call sign (station and repeaters) from the RX History list.
- While in the DR screen, or with the Menu screen or Quick Menu screen open, push to move the value or option selector bar up.

**20 EXTERNAL MICROPHONE/SPEAKER JACK**

**[MIC/SP]**

Connect a data cable, optional speaker microphone or headset.

See Section 18 in the Advanced manual for a list of available options.

**TIP:** Be sure to turn OFF the power before connecting or disconnecting optional equipment to or from the [MIC/SP] jack.

**21 VOLUME CONTROL [VOL]**

Rotate to adjust the audio volume level. (p. 12)

**22 CONTROL DIAL [DIAL]**

- ➔ Rotate to select the operating frequency. (p. 35)
- ➔ While in the Memory mode, rotate to select a memory channel. (p. 43)
- ➔ While scanning, rotate to change the scanning direction.
- ➔ Hold down [SQL], and rotate to adjust the squelch level. (p. 36)
- ➔ While in the DR screen, or with the Menu screen or Quick Menu screen open, rotate to select a desired option or value.

**◇ Quick Menu**

In the Quick Menu, the selectable items differ, depending on the operating mode or function. The items shown below are examples.

VFO mode	Memory mode	CALL-CH mode	DR function
Band Select	Bank Select	DUP	Group Select
DUP	DUP	TONE	Repeater Detail
TONE	TONE	TS	DTMF TX
TS	TS	DTMF TX	Voice TX
DTMF TX	SKIP	Voice TX	GPS Information
Voice TX	DTMF TX	GPS Information	GPS Position
GPS Information	Voice TX	GPS Position	PRI0 Watch
GPS Position	GPS Information	PRI0 Watch	Weather Alert
PRI0 Watch	GPS Position	Weather Alert	Display Type
Weather Alert	PRI0 Watch	Display Type	DSQL
Home CH Set	Weather Alert	Voltage	Home CH Set
Voltage	Home CH Set	Band scope	Voltage
Band scope	Display Type	<<REC Start>>	Band scope
<<REC Start>>	Voltage	<<BC Radio ON>>	<<REC Start>>
<<BC Radio ON>>	Band scope	<<BC Radio Mode>>	<<BC Radio ON>>
<<BC Radio Mode>>	<<REC Start>>	<<GPS Logger only>>	<<BC Radio Mode>>
<<GPS Logger only>>	<<BC Radio ON>>		<<GPS Logger only>>
	<<BC Radio Mode>>		
	<<GPS Logger only>>		

# 1 PANEL DESCRIPTION

## ■ Function display

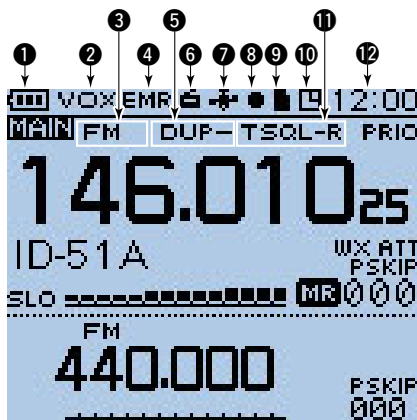

Dual band display



BC Radio setting window  
(Tuning mode)

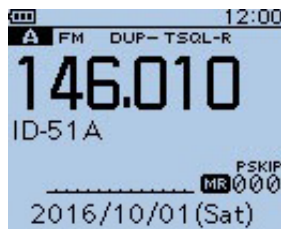

Single band display

### ① BATTERY ICON

➔ Shows the capacity of the attached battery pack.

Icon	Battery status
	The battery has sufficient capacity.
	The battery is exhausted a little.
	The battery is nearing exhaustion.
	The battery is almost fully exhausted.

➔ appears when the optional battery case is attached.

### ② VOX ICON

Appears when the optional headset is connected with the OPC-2006LS PLUG ADAPTER CABLE, and the VOX function is ON.

### ③ OPERATING MODE ICONS (p. 35)

Shows the selected operating mode.

- DV, AM, FM and FM-N are selectable.
- “DV-A” or “DV-G” appears when D-PRS (DV-A) or NMEA (DV-G) transmission is selected in the DV mode. (p. 24)

### ④ EMR/BK/Packet Loss/Auto Reply ICON

- ➔ “EMR” appears when the Enhanced Monitor Request (EMR) mode is selected. (p. 26)
- ➔ “BK” appears when the Break-in (BK) mode is selected. (p. 26)
- ➔ appears when Packet Loss has occurred. (p. 62)
- ➔ appears when the Automatic Reply function is selected. (p. 25)

**5 DUPLEX ICON**

“DUP+” appears when plus duplex is selected, and “DUP–” appears when minus duplex is selected.

**6 BC RADIO ICON (p. 41)**



Appears when the BC radio is ON.

**7 GPS ICON**



- ➔ Appears when the GPS function is ON. (pp. 13, 78)  
Stays ON when the GPS receiver is activated and valid position data is received.  
Blinks when invalid position data is being received.
  - The GPS icons can be turned OFF in the Menu screen. (p. 13)
- ➔ “((•))” blinks instead of the GPS icon, when the GPS alarm beeps.

**8 RECORD ICON (p. 74)**

Appears while recording.

-  appears while recording.
-  appears while the recording is paused.

**9 microSD ICON**

- ➔  appears when a microSD card is inserted.
- ➔  and  alternately blink while accessing the microSD card.

**10 AUTO POWER OFF ICON**

Appears when the Auto power OFF function is ON.

**11 TONE ICONS**

**While operating in the FM or FM-N mode:**

- TONE: Enables the subaudible tone encoder.
- TSQL((•)): Enables the tone squelch with the Pocket Beep function.
- TSQL: Enables the Tone Squelch function.
- DTCS((•)): Enables the DTCS squelch with the Pocket Beep function.
- DTCS: Enables the DTCS Squelch function.
- TSQL-R: Enables the Reverse Tone Squelch function.
- DTCS-R: Enables the Reverse DTCS Squelch function.
- DTCS (“DTCS” blinks):  
When you transmit, the selected DTCS code is superimposed on your normal signal.  
When you receive, the function is OFF.
- T-DTCS (“T” blinks):  
When you transmit, the selected subaudible tone is superimposed on your normal signal.  
When you receive, the DTCS squelch opens only for a signal that includes a matching DTCS code and polarity. (Audio is heard)

# 1 PANEL DESCRIPTION

## ■ Function display

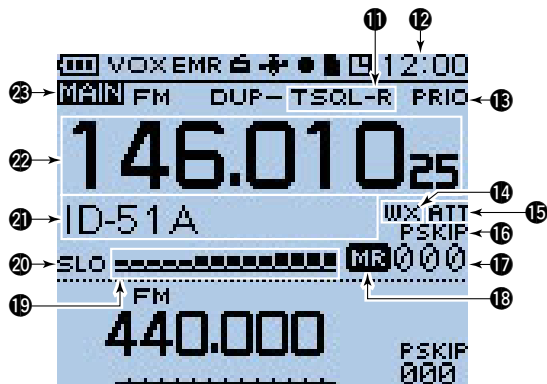

Dual band display

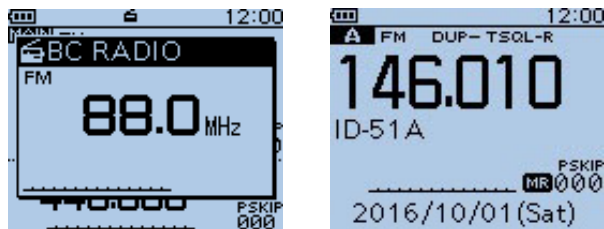

BC Radio setting window  
(Tuning mode)

Single band display

### ⑪ TONE ICONS (Continued)

- D-TSQL (“D” blinks):

When you transmit, the selected DTCS code is superimposed on your normal signal.

When you receive, the tone squelch opens only for a signal that includes a matching tone frequency. (Audio is heard)

- T-TSQL (“T” blinks):

When you transmit, the selected subaudible tone is superimposed on your normal signal. When you receive, the tone squelch opens only for a signal that includes a matching tone frequency. (Audio is heard)

### While operating in the DV mode:

- DSQL ((•)): Enables the Digital Call Sign squelch function with the Pocket Beep function.
- DSQL: Enables the Digital Call Sign squelch function.
- CSQL ((•)): Enables the Digital Code squelch function with the Pocket Beep function.
- CSQL: Enables the Digital Code squelch function.

### ⑫ CLOCK DISPLAY

Displays the current time.

### ⑬ PRIORITY WATCH ICON

Appears when Priority Watch function is ON.

### ⑭ WEATHER ALERT ICON

Appears when the Weather alert function is ON.

**15 ATTENUATOR ICON**

Appears when the attenuator is ON in the AIR band mode.

**16 SKIP ICON**

- “SKIP” appears when the selected memory channel is set as a Skip channel.
- “PSKIP” appears when the displayed frequency is set as a Skip frequency in the Memory mode.
- “PSKIP” appears while the Frequency Skip Scan function is ON in the VFO mode.

**17 MEMORY CHANNEL NUMBER**

- Displays the selected memory channel or bank number. (p. 43)
- “C0” to “C3” appears when the Call channel is selected.

**18 MEMORY ICON (p. 43)**

Appears when the Memory mode is selected.

**19 S/RF METER**

- Shows the relative signal strength of the receive signal.
- Shows the output power level of the transmit signal. (p. 39)

**20 POWER ICONS (p. 40)**

- “SLO” appears when S-low power is selected.
- “LO1” appears when Low 1 power is selected.
- “LO2” appears when Low 2 power is selected.
- “MID” appears when Mid power is selected.
- No icon appears when High power is selected.

**21 MEMORY NAME DISPLAY**

While in the Memory mode, the programmed memory or memory bank name is displayed.

**22 FREQUENCY READOUT**

Displays a variety of information, such as the operating frequency, menu contents and so on.

- The decimal point blinks during a scan.

**23 MAIN BAND ICON (p. 33)**

- Shows the selected band (A or B) is the Main band.
- “TM” appears while in the Terminal mode.
- “AP” appears while in the Access Point mode.

**TIP:** See “About the DV Gateway function” that can be downloaded from the Icom website, for details.

Before starting D-STAR, the following steps are needed or recommended.

- STEP 1** Attaching the Battery pack, and charging the battery. (p. 11)
- STEP 2** Inserting a microSD card. (p. 11)
- STEP 3** Turning ON the transceiver. (p. 12)
- STEP 4** Adjust the audio level. (p. 12)
- STEP 5** Receiving GPS data. (p. 13)
- STEP 6** Entering your Call sign (MY) into the transceiver. (p. 14)
- STEP 7** Register your Call sign at a Gateway repeater. (p. 16)
- STEP 8** Save your initial setting onto the microSD card. (p. 18)

→ You have completed the steps!!

## ■ Attaching the Battery pack

Attach or detach the battery pack or battery case, as illustrated below.

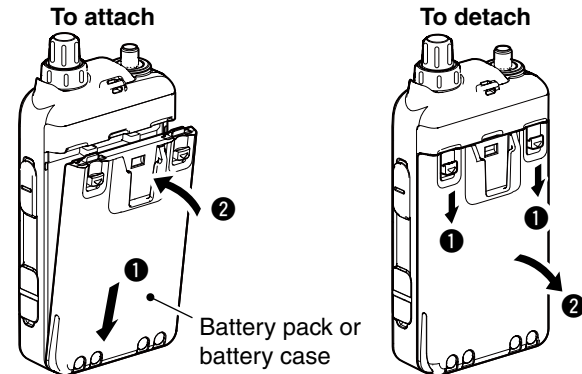

Illustration shows the battery pack is attached.

**NOTE:** Even when the transceiver power is OFF, a small current still flows in the transceiver. Remove the battery pack or case from the transceiver when not using it for a long time. Otherwise, the batteries in the pack or the case will become exhausted.

When the temperature is around 0°C (+32°F) or below, the battery protection function automatically sets transceiver power to Low1 power (0.5 W), and disables power selections (High, Mid and Low2).



## ■ Charging the battery pack

Prior to using the transceiver for the first time, the battery pack must be fully charged for optimum life and operation.

- **BE SURE** to turn OFF the power while charging with the supplied battery charger. Otherwise the attached battery pack cannot be charged.
- While charging, the charging icon “” sequentially shows eleven level steps along with the word “Charging...”.
- The icon disappears when the battery pack is completely charged.

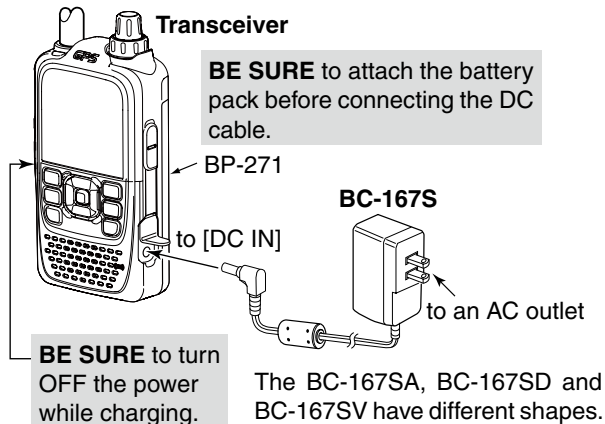

- **Charging time:** BP-271 approximately 3.0 hours  
BP-272 approximately 4.5 hours

## ■ Inserting the microSD card

- ① Make sure the transceiver is turned OFF.
- ② Lift OFF the [micro SD] slot cover on the side panel.
- ③ With the terminals facing the front, insert the card into the slot until it locks in place, and makes a ‘click’ sound.  
**DO NOT** touch the terminals.

**NOTE:** When removing, push in the microSD card until a click sounds. The card is unlocked, and you can pull it out. **DO NOT** remove the card from the transceiver while the card is being accessed. Otherwise, the card data may be corrupted or deleted. When removing the microSD card while the transceiver’s power is ON, see page 77 for details.

**NEVER** forcibly or inversely insert the card. It will damage the card and/or the slot.

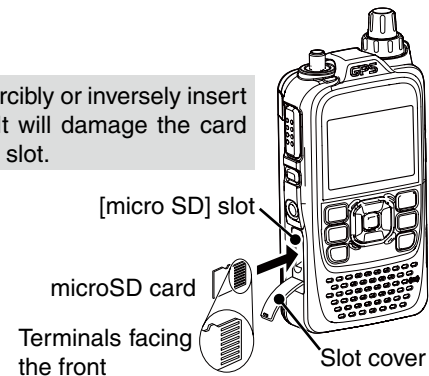

- ④ Completely close the [micro SD] slot cover.

## 2 STARTING INITIAL SETUP

### ■ Power ON

- Hold down [⏻] for 1 second to turn ON power.
  - After the opening message and power source voltage are displayed, the operating frequency or repeater name appears.
  - Hold down [⏻] for 1 second to turn OFF power.

**TIP:** The opening message and power source voltage display options can be turned ON or OFF in the Display menu. (MENU > Display > **Opening Message**) (p. 29)  
(MENU > Display > **Voltage (Power ON)**) (p. 29)

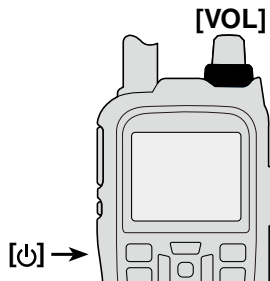

### ■ Setting audio volume

- Rotate [VOL] to adjust the audio level.
  - If the squelch is closed, hold down [SQL] while setting the audio level.
  - The display shows the volume level while adjusting.

**TIP:** The beep level is adjusted in the Sounds menu. (MENU > Sounds > **Beep Level**) (p. 30)

### ■ Setting Date/Time

The ID-51A/E has a built-in internal GPS receiver, and has a time correction function. The transceiver automatically sets the Date/Time settings to your local time.

#### ◇ Local setting

- ① Push [MENU] .
- ② Push D-pad(↑) to select the root item “Time Set,” and then push D-pad(Ent).
  - If the item is not displayed, push D-pad(↑) one or more times to select the page.

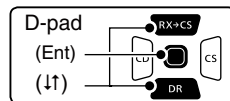

- ③ Push D-pad(↓) to select “UTC Offset,” and then push D-pad(Ent).
- ④ Push D-pad(↑) to set to your local offset time. (Example: -8:00)
- ⑤ Push [MENU]  to exit the Menu screen.

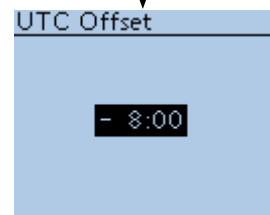
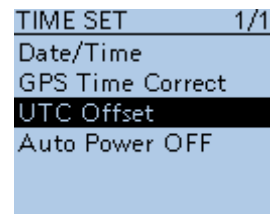

**TIP:** The “GPS Time Correct” item in the Time Set menu is set to “Auto” as the default setting. (MENU > Time Set > **GPS Time Correct**) (p. 30)

## ◇ Receiving GPS data

Check whether or not the GPS receiver is receiving your position and time.



The GPS icon blinks when searching for satellites.



The GPS icon stops blinking when the minimum number of needed satellites are found.



- It may take only a few seconds to calculate your position. But depending on the environment, it may take a few minutes. If you have difficulties receiving, we recommend that you try a different location.
- When the “GPS Select” item is set to “Manual,” the icon does not appear. (Default: Internal GPS)  
(MENU > GPS Set > **GPS Select**)

**TIP:** After the “” icon stops blinking, the transceiver automatically sets the Date/Time setting to your local time. If the “” icon does not stop blinking, manually set the “Date/Time” setting.  
(MENU > Time Set > **Date/Time**) (p. 30)

### To prolong the battery life in the GPS mode

To prolong the battery life while in the GPS is ON, manually update your position with the received GPS data.

- ① Confirm the “” icon stops blinking.
- ② Open the MANUAL POSITION screen, and then push [QUICK] <sup>QUICK</sup> <sub>SPEECH</sub>.  
(MENU > GPS > GPS Set > **Manual Position**)
- ③ Push D-pad(↑) to select “Capture From GPS,” and then push D-pad(Ent).
  - Your current position is now memorized and displayed on the MANUAL POSITION screen.

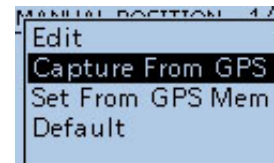

- ④ After updating, set the “GPS Select” option to “Manual.”  
(MENU > GPS > GPS Set > **GPS Select**) (p. 23)

## 2 STARTING INITIAL SETUP

### ■ Enter your call sign into the transceiver

You can enter up to six MY call signs, in [MY1] through [MY6].

#### 1. Display the MY Call Sign edit screen

Example: Enter “JA3YUA” as your own call sign into the MY call sign memory [MY1].

- 1 Push [MENU] .
  - The MENU screen is displayed.
- 2 Push D-pad(↑) to select the root item “My Station,” and then push D-pad(Ent).
  - If the item is not displayed, push D-pad(↑) one or more times to select the page.

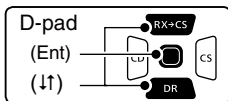

- 3 Push D-pad(↑) to select “My Call Sign,” and then push D-pad(Ent).
  - The MY CALL SIGN screen is displayed.
- 4 Push D-pad(↑) to select MY call sign memory channel “1” ([MY1]).

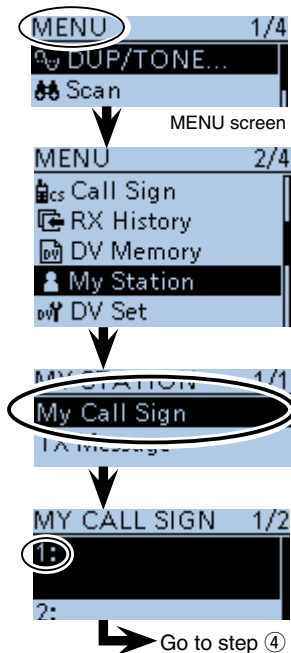

- 5 Push [QUICK] , and then push D-pad(↑) to select “Edit.” Then, push D-pad(Ent).
  - Displays the call sign edit screen.

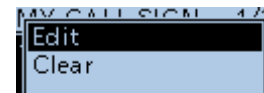

#### 2. Enter the call sign

- 6 Rotate [DIAL] to select the first digit. (Example: J)
  - A to Z, 0 to 9, / and (Space) are selectable.
  - Move cursor: Push D-pad(↔).
  - Delete: Push [CLR] .
  - Insert: Move cursor, then rotate [DIAL].
  - Rotate [DIAL] counterclockwise to enter a space.
- 7 Push D-pad(→) to move the cursor to the second digit.

**NOTE:** Your MY CALL SIGN must match the call sign registered on a gateway repeater. (p. 16)

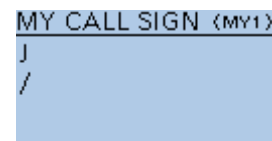

Edit mode

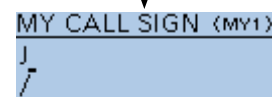

Go to step 7

⑧ Repeat steps ⑥ and ⑦ to enter your own call sign of up to 8 characters, including spaces.

(For example: First J, then A, then 3, then Y, then U, then A)

⑨ Push D-pad(Ent) to set the call sign.

- See the right column if you enter a note.

⑩ Push D-pad(Ent) again to save and return to the MY CALL SIGN screen.

- Two beeps sound.

⑪ Push [MENU] to exit the MENU screen.

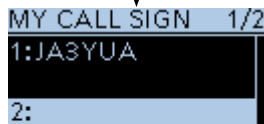
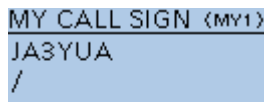

Completed | Beeps

**TIP:** You can enter a note of up to 4 characters, such as the model of the transceiver, name, area name, and so on, after your call sign.

① Push D-pad(→) until the cursor moves to the right of the “/”.

② Repeat steps ⑥ and ⑦ on the previous page to enter a desired 4 character note. (Example: ID51)

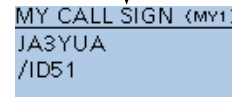
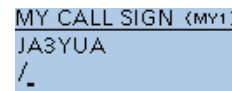

**Keys used for entry**

- [DIAL] Selects
- MENU Selects/exits the MENU screen
- W/MHz CLR LOW Deletes
- CD CS Moves the cursor
- QUICK SPCH Shows the QUICK MENU

## 2 STARTING INITIAL SETUP

### ■ Register your call sign at a gateway repeater

To use the Internet, you must register your call sign with a repeater that has a gateway, usually one near your home location.

#### About the registration process:

This section describes the call sign registration process at a repeater that is connected to the US Trust server.

There are other systems as well, and they have their own registration process. For information on how to register on one of them, contact the administrator of a repeater that uses the alternate system.

**If needed, ask the gateway repeater administrator for call sign registration instructions.**

#### 1. Go to the call sign registration screen

- ① Go to the following URL to find the gateway repeater closest to you.  
<http://www.dstarusers.org/repeaters.php>
- ② Click the call sign of the repeater that you want to register to.
- ③ Click the “Gateway Registration URL:” link address.
- ④ The “D-STAR Gateway System” screen appears. Click [Register] to start the New User registration.

D-STAR Gateway System (REV 1.0)

**Already registered?**  
Login with CallSign and Password.  
Please note that CallSign and Password are case sensitive.  
CallSign must be in Upper Case!

CallSign:   
Password:

Login

**New user?**  
Register here for D-STAR access.  
Registering takes just a few seconds, and  
you won't have to enter your personal information  
again the next time you visit here.

Register **Click**

D-STAR is a digital protocol developed by the Japan Amateur Radio League (the JARL) and stands for Digital Smart Technology for Amateur Radio.

## 2. Register your call sign

- ⑤ Follow the registration instructions on the registration screen.
- ⑥ When you receive a notification from the administrator, your call sign registration has been approved, but the whole process is not yet complete.

**NOTE:** It may take a few days for the administrator to approve you.

## 3. Register your equipment information

- ⑦ After your registration is approved, log in your personal account with your registered call sign and password.

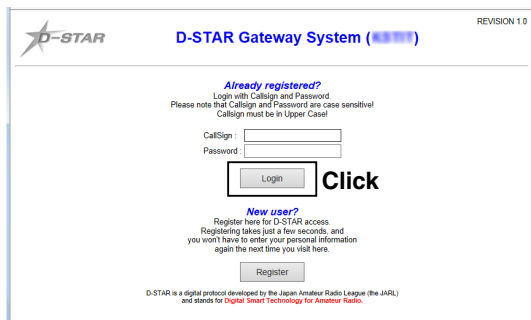

**D-STAR** **D-STAR Gateway System (REVISION 1.0)**

**Already registered?**  
 Login with CallSign and Password  
 Please note that CallSign and Password are case sensitive  
 CallSign must be in Upper Case!

CallSign:   
 Password:

**Click**

**New user?**  
 Register here for D-STAR access.  
 Registering takes just a few seconds, and  
 you won't have to enter your personal information  
 again the next time you visit here.

D-STAR is a digital protocol developed by the Japan Amateur Radio League (the JARL) and stands for Digital Smart Technology for Amateur Radio.

## 4. Register your D-Star equipment

- ⑧ Register your D-STAR equipment information.  
 Ask the gateway repeater administrator for details.
- ⑨ When your registration is complete, log out of your personal account, and start using the D-STAR network.

**NOTE:** You must register your D-STAR equipment **BEFORE** you can make calls through the gateway.

### ■ Save setting data onto a microSD card (Recommended)

Memory channels, item settings in the menu screen, and repeater lists can be saved on the microSD card.

Saving data settings on the microSD card allows you to easily restore the transceiver to its previous settings, even if an All Reset is performed.

#### ◇ Formatting the microSD card

##### TIP:

- If you use a brand new microSD card, format the card, by doing the following steps.
- **Formatting a card erases all its data.** Before formatting any programmed card, make a backup file of its current data on your PC.
- When the microSD card is formatted in the transceiver, the formatting process creates an ID-51 folder on the card. The ICF file extracted from the downloaded Zip file must be copied into the setting folder that is inside the ID-51 folder, otherwise the transceiver will not see it.

- ① Push [MENU] .
  - The MENU screen is displayed.
- ② Push D-pad(↑) to select the root item (“SD Card”), and then push D-pad(Ent).

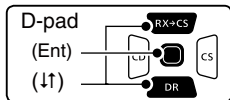

- ③ Push D-pad(↓) to select “Format,” and then push D-pad(Ent).
  - The confirmation screen “Format OK?” appears.
  - If the item is not displayed, push D-pad(↓) one or more times to select the page.
- ④ Push D-pad(↑) to select “YES,” and then push D-pad(Ent) to format.
  - The formatting starts and the display shows the formatting progress.
  - **NEVER** turn OFF the power while formatting.
- ⑤ After formatting, the display automatically returns to the SD CARD menu.



## ◇ Save setting

**TIP:** Data settings are saved in the “icf” file format that is used in the CS-51PLUS2 cloning software.  
The saved data on the microSD card can be copied onto a PC and edited with the cloning software.  
Data settings can be saved as a new file, or to overwrite an older file.

- ① Push [MENU] .
- ② Push D-pad(↑) to select the root item (“SD Card”), and then push D-pad(Ent).

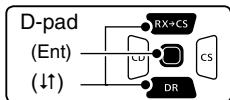

- ③ Push D-pad(↑) to select “Save Setting,” and then push D-pad(Ent).

- ④ Push D-pad(↓) to select “<<New File>>,” and then push D-pad(Ent).
  - The FILE NAME screen is displayed.
  - The file name is automatically named in the following manner, Setyyyyymmdd\_xx (yyyy: Year, mm: month, dd: day, xx: serial number)
  - Example:** If a 2nd file is saved on October 1, 2016, the file is named “Set20161001\_02”.
  - If you want to change the file name, see “Save with a different file name” (Section 2 in the Advanced manual).
- ⑤ Push D-pad(Ent) to save the file name.
  - The confirmation screen “Save file?” appears.
- ⑥ Push D-pad(↓) to select “YES,” then push D-pad(Ent) to save.
  - While saving, a progress bar is displayed, then the “SD CARD” screen is displayed after the save is completed.
- ⑦ Push [MENU]  to exit the MENU screen.

## Menu item selection

The Menu screen is used to program infrequently changed values or function settings.

In addition to this page, see pages 21 through 31 for details of each item.

**NOTE:** The Menu system is constructed in a tree structure. You may go to the next tree level, or go back a level, depending on the selected item.

### ◇ Entering the Menu screen

Example: Set the Auto Power OFF function to “30 min.”

- ① Push [MENU] .
- ② Push D-pad(↑) to select “Auto Power OFF,” and then push D-pad(Ent).

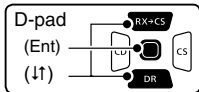

(Time Set > Auto Power OFF)

- If the item is not displayed, push D-pad(↑) one or more times to select the page.

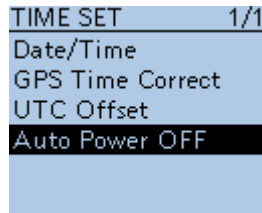

- ③ Push D-pad(↓) to select “30min.”

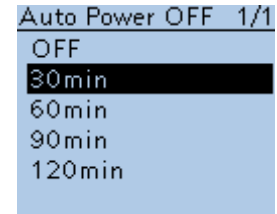

Appears

- ④ Push [MENU]  to save, and exit the Menu screen.



- TIP:** To return to the default setting, push [QUICK]  in step ④ to display “Default,” and then push D-pad(Ent).

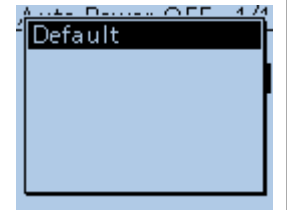

## ■ Menu items and their details

This topic describes the Menu items and their details.

### DUP/TONE...

Settings to access repeaters.

#### Offset Freq

Sets the frequency offset for duplex (repeater) operation.

#### Repeater Tone

Selects a tone frequency used to access the repeaters.

#### TSQL Freq

Selects a tone frequency for the Tone squelch or the pocket beep function.

#### Tone Burst

Turns the Tone Burst function ON or OFF.

This function is used to suppress the squelch tail noise heard from the transceiver's speaker in the FM mode.

#### DTCS Code

Selects a DTCS (both encoder/decoder) code for DTCS squelch or the pocket beep function.

#### DTCS Polarity

Selects the DTCS polarity for the DTCS squelch or the pocket beep function.

#### Digital Code

Selects a digital code for the Digital Code squelch function.

\* Be sure to insert a microSD card into the transceiver before selecting these items.

### Scan

Set scan options.

#### Pause Timer

Selects the scan pause time. When receiving signals, the scan pauses according to the scan pause timer.

#### Resume Timer

Selects the scan resume time from a pause after the received signal disappears.

#### Temporary Skip Timer

Selects the Temporary Skip Time. When the time is set, specified frequencies are skipped for this period during a scan.

#### Program Skip

Turns the Program Skip Scan function ON or OFF for a VFO mode scan.

#### Bank Link

Selects banks to be scanned during a Bank Link Scan.

#### Program Link

Sets the link function for the program scan edge channels. See the Advanced Manual for details of the preset values.

### Voice Memo

Set the TX/RX voice recording options.

#### QSO Recorder

Set QSO recorder options.

<<REC Start>>\*

Starts recording the received signal audio.

#### Play Files\*

Plays or deletes the recorded audio.

## 3 MENU SCREEN

### ■ Menu items and their details

Root item "Voice Memo" (Continued)

---

#### Recorder Set

---

##### REC Mode

Selects whether or not to record the TX audio.

##### RX REC Condition

Selects whether or not the squelch status affects the RX voice audio recording.

##### File Split

Selects whether or not to automatically create a new file if transmission and reception, or squelch status (open and close) is switched.

##### PTT Auto REC

Turns the PTT Automatic Recording function ON or OFF.

---

#### Player Set

---

##### Skip Time

Sets the Skip time to rewind or forward the recorded audio when you push the fast-rewind or fast-forward key during playback.

---

#### Voice Recorder

---

Set Voice recorder options.

##### Record\*

Starts recording the microphone audio.

##### Play Files\*

Plays or deletes the recorded audio.

##### Recorder Set

Sets the microphone sensitivity to suit your needs.

---

---

#### Player Set

---

Sets the Skip time to rewind or forward the recorded audio when you push the fast-rewind or fast-forward key during playback.

#### DV Auto Reply\*

---

Records a voice audio to use for the Auto Reply function in the DV mode.

---

---

#### Voice TX

---

Set microphone voice recording options.

##### Record\*

Starts recording the microphone audio.

##### TX Set

---

##### Repeat Time

Sets the repeat interval. The transceiver repeatedly transmits the recorded voice audio at this interval.

##### TX Monitor

The TX Monitor function outputs the TX voice audio from the speaker during voice transmission.

##### <<Single TX>>\*

The transceiver transmits the recorded voice audio only one time.

##### <<Repeat TX>>\*

The transceiver repeatedly transmits the recorded voice audio for a maximum of 10 minutes.

---

\* Be sure to insert a microSD card into the transceiver before selecting these items.

**BC Radio**

Set the Broadcast (BC) Radio options.

**BC Radio Memory**

Shows the BC Radio memory contents.

**BC Radio Set****Auto Mute**

Sets the timer to automatically mute the BC Radio audio when the transceiver transmits or receive on the A band or B band.

**FM Antenna**

Selects the desired antenna for FM.

**Power Save (BC Radio)**

Turns the Power Save (BC Radio) function ON (to save battery power) or OFF.

<<BC Radio ON>>/<<BC Radio OFF>>

Turns the BC Radio ON or OFF.

<<BC Radio Mode>>

Selects the BC Radio Mode with the transceiver in the Sleep mode.

**GPS**

Set GPS options.

**GPS Set****GPS Select**

Selects the GPS receiver that the transceiver receives its position data from.

**Power Save (Internal GPS)**

Cancels the internal GPS receiver power save function.

**Manual Position**

Manually enter your current position.

**GPS Indicator**

Turns the GPS indicator ON or OFF.

**GPS Out (To DATA jack)**

Turns the output of GPS information from the internal GPS receiver to the [DATA] jack ON or OFF.

**GPS Information**

Displays the received GPS information.

**GPS Position**

Displays your position, RX station, GPS memory and Alarm positions.

**GPS Memory**

Shows the GPS memory contents.

**GPS Alarm**

Set GPS alarm options.

**Alarm Select**

Select the target for the GPS alarm function.

**Alarm Area (Group)**

Enter the GPS alarm active range.

**Alarm Area (RX/Memory)**

Select the GPS alarm active range.

**GPS Logger\*****GPS Logger**

Turns the GPS logger function ON or OFF, to store your route as you move.

**Record Interval**

Selects the GPS Logger function record interval.

## 3 MENU SCREEN

### ■ Menu items and their details

Root item "GPS" (Continued)

---

#### **Record Sentence**

Selects the GPS Logger function record sentences.

---

#### **<<GPS Logger Only>>**

Turns ON the GPS logger function with the transceiver in the Sleep mode.

---

#### **GPS TX Mode**

Set the GPS TX mode.

---

#### **OFF**

Turns OFF the GPS TX function.

---

#### **D-PRS (DV-A)**

Set D-PRS options.

---

#### **Unproto Address**

Enters an unproto address, or keep the default.

---

#### **Symbol**

Selects a object station's symbol to transmit.

---

#### **SSID**

Selects the APRS® call sign SSID.

---

#### **Comment**

Enters a comment to transmit.

---

#### **Time Stamp**

Selects a format to transmit the current UTC time as a time stamp.

---

#### **Altitude**

Turns the altitude transmit option ON or OFF.

---

#### **Data Extension**

Selects whether or not to transmit the course/speed data, power/height/gain/directivity data.

---

#### **NMEA (DV-G)**

Set NMEA options.

---

#### **GPS Sentence**

Transmits position data in selected GPS sentences.

---

#### **GPS Message**

Enter a GPS message to be transmitted.

---

#### **GPS Auto TX**

Selects a time option for the GPS automatic transmission function.

---

#### **Call Sign**

Set and display the DV mode call signs.

**UR: CQCQCQ, R1: -----, R2: -----, MY: -----**

Displays the operating call signs.

Sets the operating call signs according to the type of call you want to make.

---

#### **RX History**

Displays the received call history in the DV mode.

---

#### **RX01:**

Displays the calls your transceiver received.

---

#### **DV Memory**

Stores call signs or repeater information to use in the DV mode.

---

#### **Your Call Sign**

Stores station call signs. Add or edit call signs.

**Repeater List\***

Stores repeater information. Add or edit repeater information.

(See the Advanced Manual for details of the preloaded data.)

**NOTE:** The repeater list described in this manual may differ from your preloaded list.

**My Station**

Sets and stores your call sign to use in the DV mode.

**My Call Sign**

Stores your call signs.

Select or edit a call sign to use in the DV mode.

**TX Message**

Stores TX Messages.

Select or edit TX Message to use in the DV mode.

**DV Set**

Sets values for the DV mode operations.

**Tone Control**

Set the received audio tones.

**RX Bass**

Sets the DV mode received audio bass filter level to Cut, Normal or Boost.

**RX Treble**

Sets the DV mode received audio treble filter level to Cut, Normal or Boost.

**RX Bass Boost**

Turns the DV mode received audio Bass Boost function ON or OFF

**TX Bass**

Sets the DV mode transmit audio bass filter level to Cut, Normal or Boost.

**TX Treble**

Sets the DV mode transmit audio treble filter level to Cut, Normal or Boost.

**Auto Reply**

Selects the Automatic Reply function.

**DV Data TX**

Selects manually or automatically to transmit data.

**DV Fast Data**

The DV Fast data mode sends data through both the audio and data frames in the DV mode. The data speed of the DV Fast data mode (approximately 3480 bps) is 3.5 times faster than the low-speed data communication mode (approximately 950 bps).

In the DV Fast data mode, no audio can be sent.

**Fast Data**

Selects whether or not to use DV Fast data mode for data communication in the DV mode.

**GPS Data Speed**

Set the GPS data transmission speed in the DV Fast data mode.

**TX Delay (PTT)**

Set the TX delay time after releasing [PTT] when the "DV Data TX" is set to "PTT" and data is sent in the DV Fast data mode.

\* Be sure to insert a microSD card into the transceiver before selecting these items.

## 3 MENU SCREEN

- Menu items and their details  
Root item "DV Set" (Continued)

---

### Digital Monitor

Selects the DV mode RX monitoring when [SQL] is held down.

---

### Digital Repeater Set

Turns the digital repeater setting function ON or OFF. This function is usable in any DV mode except when using the DR function.

---

### RX Call Sign Write

Turns the RX call sign automatic write function ON or OFF. This function is usable in any DV mode except the DR screen.

---

### RX Repeater Write

Turns the repeater call sign automatic write function ON or OFF. This function is usable in any DV mode except when using the DR function.

---

### DV Auto Detect

Turns the DV mode automatic detect function ON or OFF.

---

### RX Record (RPT)

The transceiver can record the data of up to 50 individual calls.

---

### [RX>CS] Key

Selects the [RX>CS] key's operation when held down.

---

### BK

Turns the BK (Break-in) function ON or OFF. The BK function allows you to break into a conversation between two stations with call sign squelch enabled.

---

---

### EMR

Turns the EMR (Enhanced Monitor Request) communication mode ON or OFF.

After turning OFF the transceiver, the EMR mode will be cancelled.

---

### EMR AF Level

Sets the audio output level when an EMR mode signal is received.

---

---

## SPEECH

Sets the Speech functions.

---

### RX Call Sign SPEECH

Selects the RX call sign speech function option while ON, or turn it OFF.

---

### RX>CS SPEECH

Turns the RX>CS Speech function ON or OFF.

---

### DIAL SPEECH

Turns the Dial Speech function ON or OFF.

---

### MODE SPEECH

Turns the Operating Mode Speech function ON or OFF.

---

### SPEECH Language

Selects either English or Japanese as the desired speech language.

---

### Alphabet

Selects the alphabet character announcement type.

---

### SPEECH Speed

Selects Slow or Fast speech speed

---

### SPEECH Level

Sets the volume level for the voice synthesizer.

---



**DTMF/T-CALL**

Sets the DTMF Memory functions.

**DTMF Memory**

Shows a list of the DTMF memory channels. The DTMF memory can store up to 24-digit DTMF code.

**DTMF Speed**

Selects the DTMF transfer speed.

**QSO/RX Log**

Sets the QSO/RX History Log options.

**QSO Log\***

Selects whether or not to make a communication log on the microSD card.

**RX History Log\***

Selects whether or not to make a DV mode's receive history log on the microSD card.

**CSV Format**

Set CSV format options.

**Separator/Decimal**

Selects the separator and the decimal character for the CSV format.

**Date**

Selects the date format.

**Function**

Sets various function's options.

**Power Save**

Selects the Power Save options to reduce current drain and conserve battery power.

**Monitor**

Selects the [SQL] monitor function method.

**Dial Speed-UP**

Turns the dial speed acceleration ON or OFF.

**Auto Repeater**

Turns the Auto Repeater function ON or OFF.

**Remote MIC Key**

The function assignments for keys on the optional HM-75LS can be changed for simple remote control operation.

**During RX/Standby**

Selects the key function to be used while receiving or in the standby mode.

**During TX**

Selects the key function to be used while transmitting.

**Key Lock**

Selects the key lock type when the Key Lock function is turned ON.

**PTT Lock**

Turns the PTT Lock function ON or OFF.

**Busy Lockout**

Turns the Busy Lockout function ON or OFF.

**Time-Out Timer**

Selects the Time-Out Timer time options.

\* Be sure to insert a microSD card into the transceiver before selecting these items.

## 3 MENU SCREEN

### ■ Menu items and their details

Root item "Function" (Continued)

---

#### Active Band

Allows continuous frequency selection across all bands by rotating [DIAL].

---

#### MIC Gain (Internal)

Sets the internal microphone sensitivity to suit your preference.

---

#### MIC Gain (External)

Sets the external microphone sensitivity to suit your preference.

---

#### Data Speed

Selects the data transmission speed for low-speed communication, or between the [DATA] jack and external modules like a GPS receiver, and so on.

---

#### VOX

##### VOX

Turns the VOX function ON or OFF.

---

##### VOX Level

Sets the VOX gain level.

---

##### VOX Delay

Sets the VOX Delay time.

---

##### VOX Time-Out Timer

Sets the VOX Time-Out Timer to prevent an accidental prolonged transmission.

---

##### Headset Select

Selects the headset type to be used for the VOX function to limit the maximum audio output level to protect the headset speaker.

---

#### CI-V

Set CI-V options.

---

##### CI-V (DATA Jack)

Selects whether or not to use the [DATA] jack to control an external device.

---

##### CI-V Address

Sets the transceiver's unique CI-V hexadecimal address code.

---

##### CI-V Baud Rate

Sets the CI-V code transfer speed.

---

##### CI-V Transceive

Turns the CI-V Transceive function ON or OFF.

---

#### Heterodyne

Effective to eliminate internal spurious that may occur in a rare combination of dual band frequencies.

---

#### Charging (Power ON)

When the external DC power cable is connected, this function enables charging the battery even with the power ON.

---

#### Display

Sets the Display options.

---

##### Backlight

Selects the transceiver backlight option.

---

##### Backlight Timer

Selects the backlight ON time period.

---

##### LCD Dimmer

Selects the LCD backlight brightness level.

---

##### LCD Contrast

Sets the contrast level of the LCD.

**Busy LED**

Turns the TX/RX indicator ON or OFF.

**RX Call Sign**

Selects the call sign and message display option when receiving a call.

**RX Message**

Selects to display and scroll a received message when receiving a call, or not.

**Reply Position Display**

Selects whether or not to display the caller's position data when the data is included in the Auto Reply signal.

**DV RX Backlight**

Turns the DV RX Backlight function ON or OFF.

**TX Call Sign**

Selects whether or not to display My or Your call sign while transmitting.

**Scroll Speed**

Selects the scrolling speed of the message, call sign, or other text.

**Opening Message**

Selects whether or not to display the opening message at power ON.

**Voltage (Power ON)**

Selects whether or not to display the voltage of the battery or external DC power source at power ON.

**Display Unit**

Set Display units options.

**Latitude/Longitude**

Selects position format to display the position.

**Altitude/Distance**

Selects the units to display the distance and altitude.

**Speed**

Selects the units to display the speed.

**Temperature**

Selects the units to display the temperature.

**Barometric**

Selects the units to display the barometric pressure.

**Rainfall**

Selects the units to display the rainfall.

**Wind Speed**

Selects the units to display the wind speed.

**Display Language**

Selects the display language in the DR screen or Menu mode. When "English" is selected in System Language, this setting will disappear.

**System Language**

Selects English or Japanese as the system language of the transceiver.

**Sounds**

Sets the Sound options.

**Volume Select**

Selects to adjust the audio output level of all bands together, all separately, or just the BC Radio separately.

**BC Radio Level**

Sets the initial audio output level difference between the BC Radio and the A and B bands when "All" is set in "Volume Select."

## 3 MENU SCREEN

- Menu items and their details  
Root item "Sound" (Continued)

---

### Earphone Mode

Turns the Earphone mode ON or OFF.

---

### Beep Level

Sets the beep output level.

---

### Beep/Vol Level Link

Selects whether or not the beep output level can be adjusted by the [VOL] control.

---

### Key-Touch Beep

Turns the confirmation beep tones when key is pushed, ON or OFF.

---

### Home CH Beep

Turns the Home CH Beep ON or OFF.

---

### Band Edge Beep

Turns the Band edge beep ON or OFF.

---

### Scan Stop Beep

Turns the scan stop beep ON or OFF.

---

### Standby Beep

Turns the standby beep function in the DV mode ON or OFF.

---

### Sub Band Mute

Selects to mute the SUB band audio signal while receiving on the MAIN band, and/or sound a beep when a signal disappears on the SUB band.

---

### Scope AF Output

Selects the audio output option during a sweep.

---

### Time Set

Sets the Time options.

---

#### Date/Time

Sets the current date and time.

---

#### GPS Time Correct

Sets to automatically correct the time using a GPS signal.

---

#### UTC Offset

Enters the time difference between UTC and the local time.

---

#### Auto Power OFF

Turns the Auto power OFF function ON or OFF.

---

### DV Gateway

Enters the Terminal mode or Access Point mode.

<<Terminal Mode>>

Enters the Terminal mode.

<<Access Point Mode>>

Enters the Access Point mode.

---

### SD Card\*

Sets the SD card options.

---

#### Load Setting

---

##### File selection

Loads the settings file to the transceiver.

---

#### Save Setting

---

##### <<New File>>

Saves the settings as a new file.

---

##### File selection

Saves the settings in a selected file.

\* Be sure to insert a microSD card into the transceiver before selecting these items.

**Import/Export**

Import or export the CSV format file.

**Import**

Selects to import the Your call sign, Repeater list, or GPS memory data in the CSV format file.

**Export**

Selects to export the Your call sign, Repeater list, or GPS memory data in the CSV format file.

**CSV Format**

Selects the separator and the decimal character for the CSV format.

**Separator/Decimal**

Selects the separator and the decimal character for the CSV format.

**Date**

Selects the date format.

**SD Card Info**

Displays the free space and remaining recording time of the card.

**Format**

Formats the card.

**Unmount**

Electronically unmounts the card.

**Others**

Sets other options.

**Information****Voltage**

Shows the voltage of the external DC power source.

**Version**

Shows the transceiver's firmware version number.

**Clone****Clone Mode**

Reads or writes the CS-51PLUS2 data from or to the PC.

**Clone Master Mode**

Sends the memory or setting data to other ID-51A/E. The clone Master mode of the Transceiver to Transceiver.

**Reset****Partial Reset**

Returns all settings to their defaults, without clearing the memory contents, call sign memories or repeater lists.

**All Reset**

Clears all programming and memories, and return all settings to their defaults.

## ■ Receiving

- ① Select the Main band. (p. 33)
  - A band or B band are selectable.
- ② Select the operating band. (p. 34)
  - Air , 144 MHz or 430 MHz bands are selectable.
- ③ Select the operating mode. (p. 35)
  - AM, FM, FM-N and DV modes are selectable.
- ④ Set the operating frequency. (p. 35)
- ⑤ Set the Squelch level. (p. 36)

## ■ Dualwatch operation

Dualwatch operation simultaneously monitors two frequencies. The ID-51A/E has two independent receiver circuits, A band and B band.

Depending on the operating band or mode, the SUB band audio signal is muted. In such case, "MUTE" appears. In the Dualwatch mode, the audio output may be interrupted when the frequency is switched while scanning, or by other factors.

### Frequency range on the A/B bands:

108.000 MHz to 174.000 MHz
----------------------------

380.000 MHz to 479.000 MHz
----------------------------

- Some frequency ranges are blocked for the USA and Australian versions by regulation.

### ○ SUB band mute status

MAIN band	SUB band
DV mode	DV mode
	FM-N mode
FM-N mode	DV mode
	FM-N mode
AIR band	AIR band

Example: MAIN band is FM-N mode.  
SUB band is DV mode.

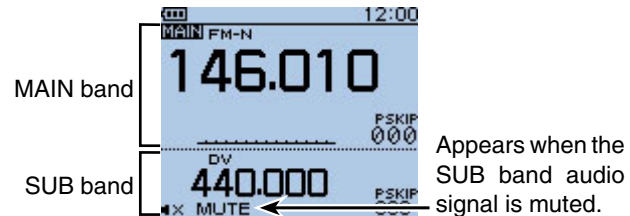

◇ Turning Dualwatch ON or OFF

- ➔ Hold down [DUAL] <sup>(MAIN DUAL)</sup> for 1 second to turn the Dualwatch operation ON or OFF.
- In the Dualwatch mode, the display shows the A band in the upper half and the B band in the lower half.

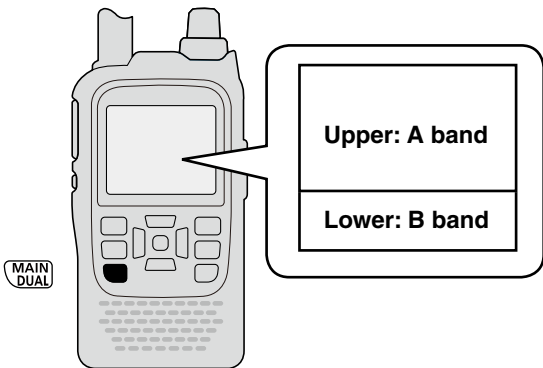

- When Dualwatch operation is OFF, the display shows only the MAIN band.

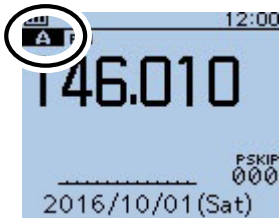

A band is displayed

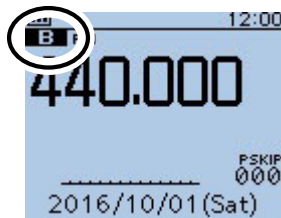

B band is displayed

◇ MAIN band selection

- ➔ Push [MAIN] <sup>(MAIN DUAL)</sup> to alternately select the upper band or lower band as the MAIN band.
- "MAIN" appears on the MAIN band.
- Band selection, operating frequency setting using [DIAL], operating mode selection, Memory channel selection, memory write and band scope function can be made on the MAIN band.

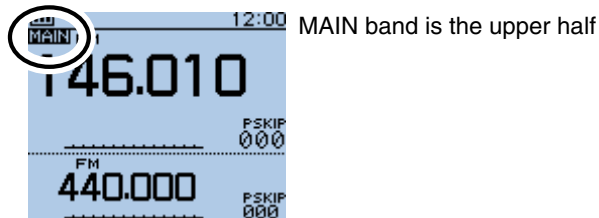

MAIN band is the upper half

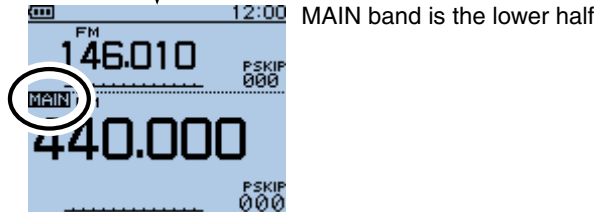



MAIN band is the lower half

## 4 BASIC OPERATION

### ■ Selecting the operating band

The transceiver can receive the AIR, 144 MHz or 430 MHz bands.

- ① Push [V/MHz]  to select the VFO mode.
- ② Push [QUICK] .
- ③ Push D-pad(↑) to select “Band Select,” and then push D-pad(Ent).

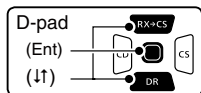

- ④ Push D-pad(↓) to select the desired frequency band.
  - Selectable frequency bands differ, depending on the transceiver version. See the specifications for details. (p. 90)
- ⑤ Push D-pad(Ent) to set and exit the Quick Menu screen.

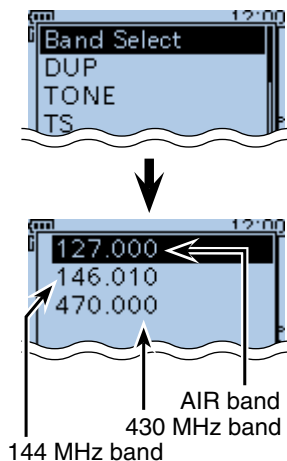

### ■ Selecting the tuning step

Rotating [DIAL] changes the frequency in the selected tuning step.

The VFO scan uses this step when searching for signals.

The following tuning steps are selectable. (kHz)

5.0	6.25	8.33*	10.0	12.5	15.0	20.0
25.0	30.0	50.0	100.0	125.0	200.0	

\*Appears only when the AIR band is selected.

#### ◇ Tuning step selection

- ① Push [QUICK] .
- ② Push D-pad(↑) to select “TS,” and then push D-pad(Ent).

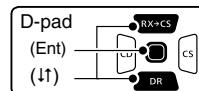

- ③ Push D-pad(↓) to select the desired tuning step.
  - You can set the tuning step for both the VFO and Memory modes.
- ④ Push D-pad(Ent) to save the setting and exit the Quick Menu screen.

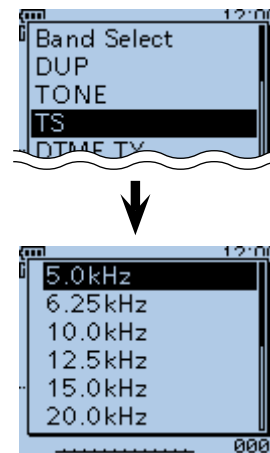

When 5.0 kHz tuning steps is selected.





## ■ Selecting the operating mode

Operating modes are determined by the modulation of the radio signals. The transceiver has a total of four operating modes, AM, FM, FM-N and DV.

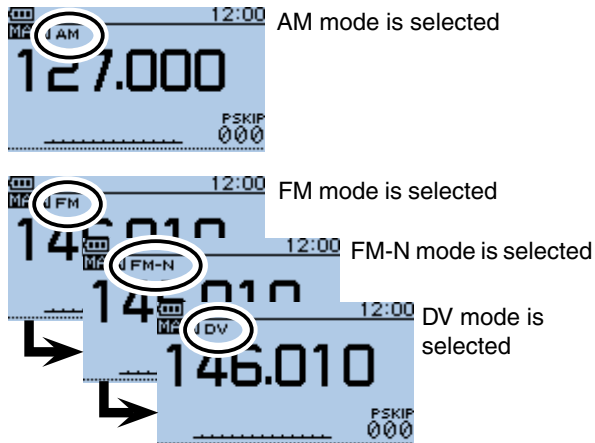
- ➔ Push [MODE]  one or more times to select the operating mode.
  - The AM mode can be used for only the AIR band (108.000 MHz ~ 136.995 MHz) and AM BC radio (0.520 MHz ~ 1.710 MHz). (p. 42)
  - When the “GPS TX Mode” item is set, “DV-A” or “DV-G” appears instead of “DV.” (p. 24)



## ■ Setting a frequency

- ① When the VFO mode is selected, push [V/MHz]  to select the 1 MHz or 10 MHz Quick Tuning function step, or turn it OFF.
  - When the 1 MHz step is selected, the 1 MHz digit blinks.
  - When the 10 MHz step is selected, the 10 MHz digit blinks.
- ② Rotate [DIAL] to select the desired frequency in 1 MHz or 10 MHz steps.
- ③ When 10 MHz steps are selected, push [V/MHz]  to cancel the Quick Tuning function.

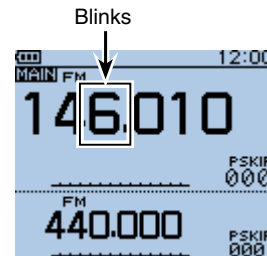

When the frequency changes in 1 MHz steps.

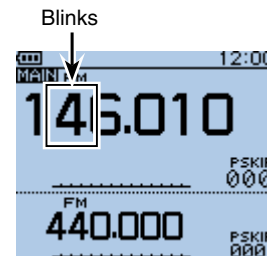

When the frequency changes in 10 MHz steps.

## 4 BASIC OPERATION

### ■ Setting the squelch level

- ① While holding down [SQL], rotate [DIAL] one click to displace the current squelch level.
- ② While holding down [SQL], rotate [DIAL] to select the squelch level.
  - “LEVEL1” is loose squelch (for weak signals) and “LEVEL9” is tight squelch (for strong signals).
  - “AUTO” shows automatic level adjustment by a noise pulse counting system.
  - “OPEN” shows a continuously open setting. (This option is not selectable in the DV mode.)

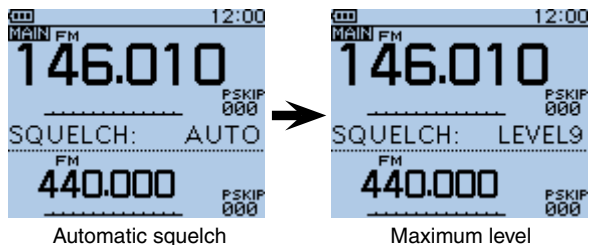

**NOTE:** An independent squelch level can be set for the A band and B band. You can set the MAIN band's squelch level.

### ■ Monitor function

This function is used to listen to weak signals without disturbing the squelch setting, or having to open the squelch manually, even when mute functions such as tone squelch are in use.

- ➔ While holding down [SQL], the transceiver monitors the operating frequency.
  - The 1st segment of the S-meter blinks.

**TIP:** The [SQL] key can be set to 'sticky' operation in the Function menu. (MENU > Function > **Monitor**) (p. 27)

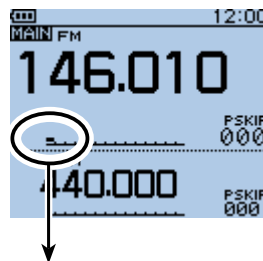

The first segment blinks.

## ■ Selecting the Mode and the DR function

### • VFO mode

The VFO mode is used to set the desired frequency.

### • Memory mode

The Memory mode is used to operate on Memory channels, which store programmed frequencies and other parameters.



### • Call channel mode

Call channels are used for quick recall of most-often used frequencies.

### • Weather channel mode\*

Weather channels are used for monitoring weather channels from the NOAA (National Oceanographic and Atmospheric Administration) broadcasts.

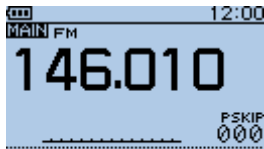

### ◇ VFO mode

- ① Push [V/MHz] .
  - Push [V/MHz]  selects the 1 MHz or 10 MHz Quick Tuning function step, or turns it OFF.
- ② Rotate [DIAL] to set the operating frequency.



VFO mode

### ◇ Memory/Call channel/Weather channel\* mode

- ① In the VFO mode, push [M/CALL]  to select the Memory mode.
  - “MR” and the selected Memory channel number appear.
- ② Push [M/CALL]  again to select the Call channel mode, and then push again to select the Weather channel mode.
  - The Memory mode, Call channel mode or Weather channel mode\* are alternately selected.
  - In the Call channel mode, the selected Call channel number (“C0” to “C3”) appears.
  - In the Weather channel mode\*, the selected weather channel number (“WX-01” to “WX-10”) appears.
- ③ Rotate [DIAL] to select a desired channel.

\*Appears in only the USA version transceivers.

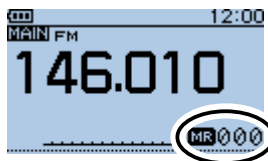

Memory mode

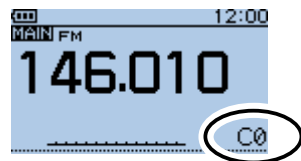

Call channel mode

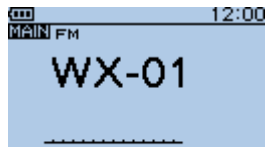

Weather channel mode\*

## 4 BASIC OPERATION

### ■ Selecting the Mode and the DR function (Continued)

#### ◇ Selecting the DR (D-STAR Repeater) function

The DR (D-STAR Repeater) function is used for D-STAR repeater operation. With this function, you can easily select the programmed repeaters and Your call signs by rotating [DIAL].

See page 45 for the DR function details.

- Hold down [DR] for 1 second.
  - Displays the DR screen.

**TIP:** See section 6 of this manual or sections 7 through 9 in the Advanced manual for details of the D-STAR operation with the DR function.

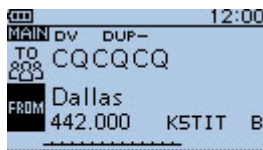

DR screen

### ■ Key Lock function

Activate to prevent accidental frequency changes and unnecessary function access.

- Hold down [LOCK] [MENU] for 1 second to turn ON the Key Lock function.
  - When the Key Lock function is activated and the locked key or [DIAL] is pushed or rotated, "LOCK ON" appears.
  - To turn OFF the function, hold down [LOCK] [MENU] for 1 second again.
  - [P], [LOCK] [MENU], [PTT], [SQL] and [VOL] can be used while the lock function is activated.

**TIP:** Either or both the squelch control and volume control can also be locked in the Function menu.  
(MENU > Function > **Key Lock**) (p. 27)



The function is ON



The function is OFF

## ■ Transmitting

**CAUTION:** Transmitting without an antenna will damage the transceiver.

**NOTE:** To prevent interfering, hold down [SQL] to listen on the channel before transmitting.

- ① Set the operating frequency. (p. 35)
  - Transmitting can be done only when the 144 MHz or 430 MHz amateur band is selected as the MAIN band.
- ② Hold down [LOW]  $\left[ \begin{smallmatrix} \text{V/MHz} \\ \text{CLR LOW} \end{smallmatrix} \right]$  for 1 second to select the transmit output power between S-Low, Low1, Low2, Mid and High to suit your operating requirements.
  - Or while holding down [LOW]  $\left[ \begin{smallmatrix} \text{V/MHz} \\ \text{CLR LOW} \end{smallmatrix} \right]$ , rotate [DIAL] to select the output power.
  - No icon appears when high power is selected.
  - “SLO,” “LO1,” “LO2” or “MID” appears when S-low, Low 1, Low 2 or Mid power is selected.
- ③ Hold down [PTT] to transmit, and speak at your normal voice level.
  - The TX/RX indicator lights red.
  - The S/Rf meter displays the output power level.
- ④ Release [PTT] to receive.

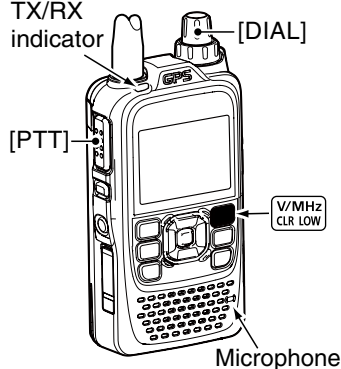

**⚠ WARNING! NEVER** transmit for long periods of time. During prolonged transmissions at high power or mid power, the transceiver radiates heat to protect itself from overheating. The transceiver's chassis will become hot and may cause a burn.

- To prevent the transceiver's overheating, the default setting of the time-out timer function is set to 5 minutes (p. 27). Be careful when the time-out timer function is turned OFF or set to a long time period, and you transmit for long periods.

**DO NOT** operate the transceiver where heat dissipation will be obstructed if the transceiver is also being charged with an external power supply. Poor heat dissipation may cause a burn, warp the casing or damage the transceiver.

**NOTE:** When the transceiver becomes hot, the transceiver's heat protection function gradually reduces the output power to approximately 2.5 watts, then it stops transmission after that. This is done to protect the transceiver itself until it can cool down.

**CONNECT** to only the rated voltage range when using an external power supply.

## 4 BASIC OPERATION

### ◇ About transmit power levels

- When the external DC power cable (13.5 V DC) is connected, or a BP-271/BP-272 is used:

5 W (High)/2.5 W (Mid)/1.0 W (Low2)/  
0.5 W (Low1)/0.1 W (S-Low) (approximately)

- When the BP-273 is used:

Approximately 0.1 W (S-LOW) (fixed)

**NOTE:** When using the BP-273 battery case, “SLO,” “LO1,” “LO2,” “MID” or no icon (high power) appears on the display by holding down [LOW]  $\left[ \frac{V/MHz}{CLR LOW} \right]$  for 1 second. But “SLO” appears while transmitting, and the output power is limited to approximately 0.1 watts.

### • Transmit power level display



High power (5 W)



Mid power (2.5 W)



Low2 power (1.0 W)



Low1 power (0.5 W)





S-Low power (0.1 W)

## ■ BC Radio operation

### ◇ Turning ON the BC Radio

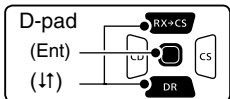
- ① Push [QUICK] .
- ② Push D-pad(↑) to select “<<BC Radio ON>>,” and then push D-pad(Ent).



- ③ The BC Radio pop up window appears, and exits the Quick Menu screen.
  - “

**TIP:** To turn OFF the BC Radio, push [QUICK] , and then select “<<BC Radio OFF>>.”

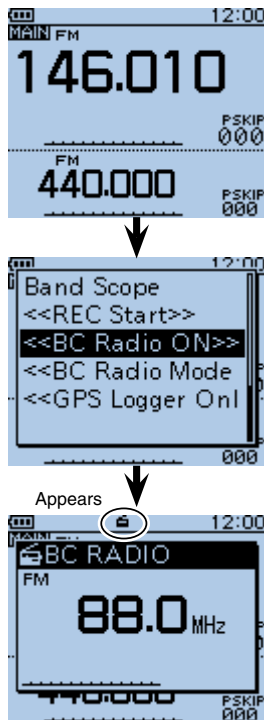

### ◇ AM/FM radio mode selection

➔ Push [MODE]  to select the AM or FM radio mode.

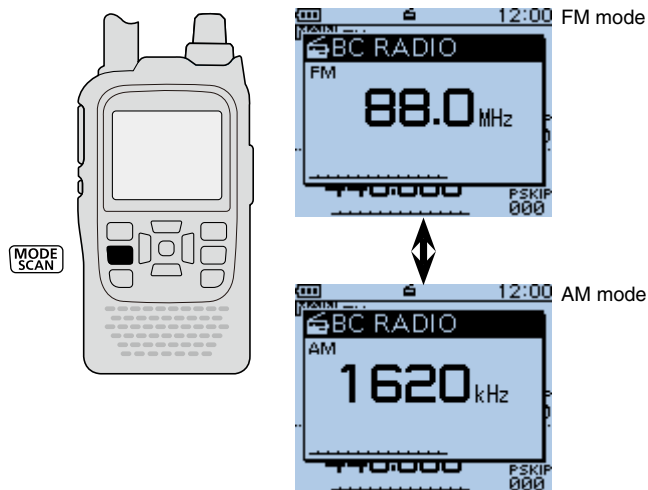

**NOTE:** This transceiver does not have a built-in bar antenna for AM broadcast band reception. If you have difficulties receiving depending on your environment, we recommend that you try a different location, or use an antenna which better suits the AM broadcast band.

## Memory channel programming

The Memory mode is useful to quickly select often-used repeaters.

This section describes the basic channel programming.

See the Advanced Manual for details.

Example: Programming 146.030 MHz into memory channel 11 (a blank channel).

① Push [V/MHz] (V/MHz CLR LOW) to select the VFO mode.

② Rotate [DIAL] to set a frequency to 146.030 MHz.

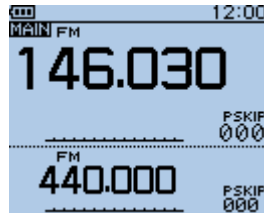

Hold down (M/CALL S.MW) for 1 sec.

③ Hold down [S.MW] (M/CALL S.MW) for 1 second to enter the Select Memory write mode.

- 1 short and 1 long beep sound.
- The memory channel number blinks, and memory contents are displayed.



④ Rotate [DIAL] to select channel 11.

- Select Call channels (C0 to C3) to program into a call channel, VFO to program into VFO or scan edge channels (0A/0B to 24A/24B) to program into a scan channel.

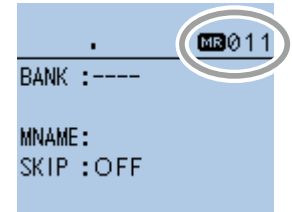

Hold down (M/CALL S.MW) for 1 sec.

⑤ Hold down [S.MW] (M/CALL S.MW) for 1 second to program, and then return to the VFO mode.

- 3 beeps sound.
- Before returning to the VFO mode, the programmed memory contents are briefly displayed.

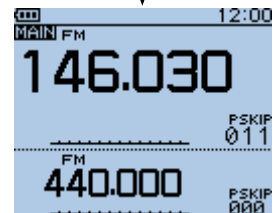



## ■ Selecting the Memory channel

In the memory mode, you can select the programmed memory channels by rotating [DIAL].

- ① Push [M/CALL]  $\left[ \begin{smallmatrix} \text{M/CALL} \\ \text{S.MW} \end{smallmatrix} \right]$  one or more times to enter the Memory mode.

- “MR” appears when the Memory mode is selected.
  - Push [M/CALL]  $\left[ \begin{smallmatrix} \text{M/CALL} \\ \text{S.MW} \end{smallmatrix} \right]$  again to select the Memory mode or Weather channel mode\*. The Memory mode, Call channel mode or Weather channel mode\* are alternately selected.
- \*Appears only for the USA version transceivers.

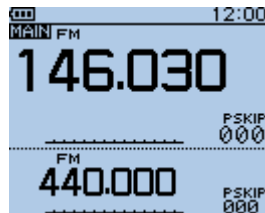

Push  $\left[ \begin{smallmatrix} \text{M/CALL} \\ \text{S.MW} \end{smallmatrix} \right]$ .

- ② Rotate [DIAL] to select a desired memory channel.

- Memory channels: “000” ~ “499”
- Scan edge channels: “0A/0B” ~ “24A/24B”
- Only programmed memory channels can be selected.
- See previous page for memory programming details.

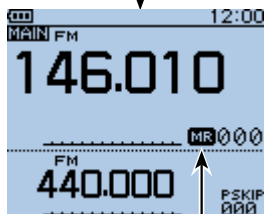

Appears

Example: Selecting the Memory channel 7

Rotate [DIAL] to select channel 7.

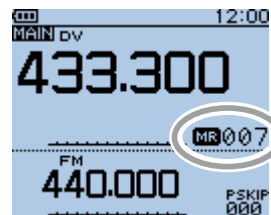

- ③ Push [CLR]  $\left[ \begin{smallmatrix} \text{V/MHz} \\ \text{CLR LOW} \end{smallmatrix} \right]$  to exit the Memory mode.

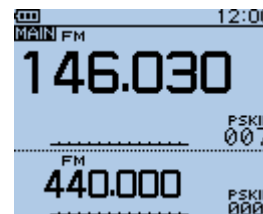

## ■ Unique features of D-STAR

- Easy Cross band operation through the repeater
- Easy call sign entry with the Repeater list or TX/RX History
- Call Sign Capture key [RX>CS] makes call sign capture easy.

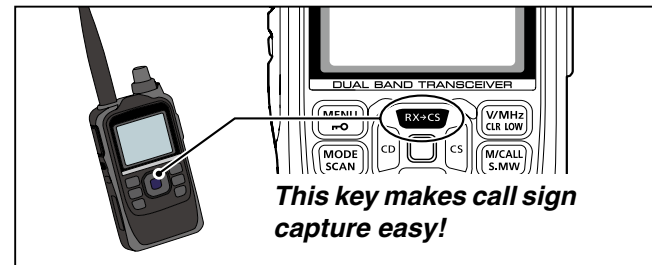
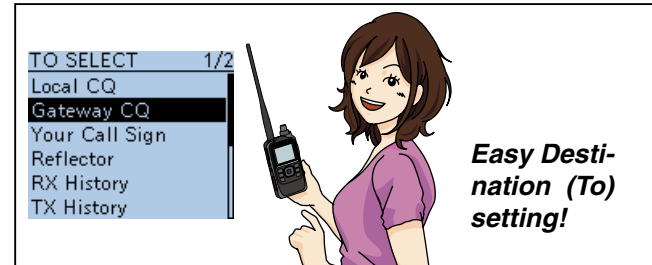
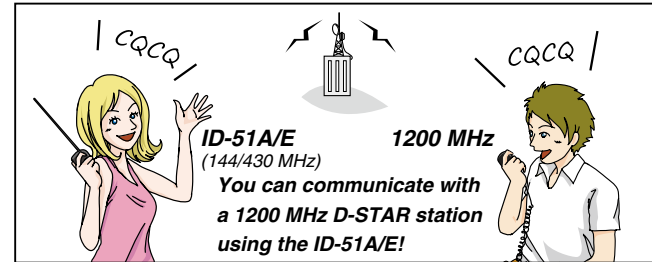

Before starting D-STAR, the following steps are needed.

**STEP 1** Entering your call sign (MY) into the transceiver.

**STEP 2** Registering your call sign (MY) to a gateway repeater.

**STEP 3** Entering your D-STAR equipment into your registration form.

→ You have completed the steps!!

See pages 14 to 17 for details.

**IMPORTANT!**

## ■ D-STAR Introduction

- The D-STAR repeater enables you to call a HAM station near you, or around the world.
- You can transmit and receive digital voice, including low-speed data, at the same time. You can transmit and receive position data from the built-in GPS receiver.

## ■ About the DR (D-STAR Repeater) function

You can easily use D-STAR repeaters with the DR (D-STAR Repeater) function. With this function, you can select the programmed repeater or frequency in "FROM" (the access repeater or simplex), and Your call sign in "TO" (destination), as shown to the right.

**NOTE:** If the repeater set in "FROM" (Access Repeater) has no Gateway call sign, you cannot make a gateway call.

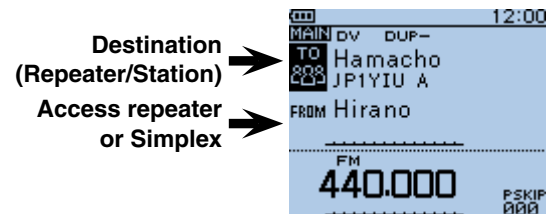

In the DR screen

### ■ Ways to Communicate with the DR function

With the DR function, the transceiver has three ways to communicate, as shown below.

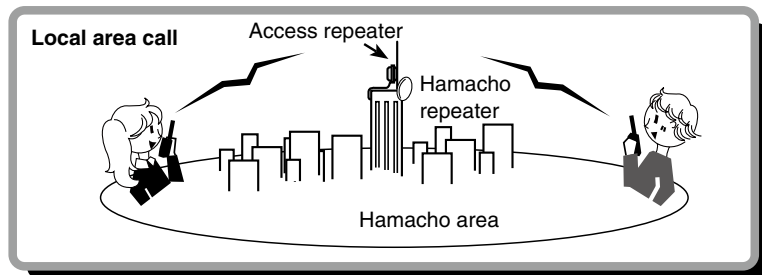

To call through your local area (access) repeater.

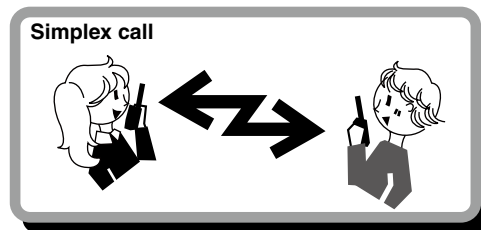

To call another station not using a repeater.

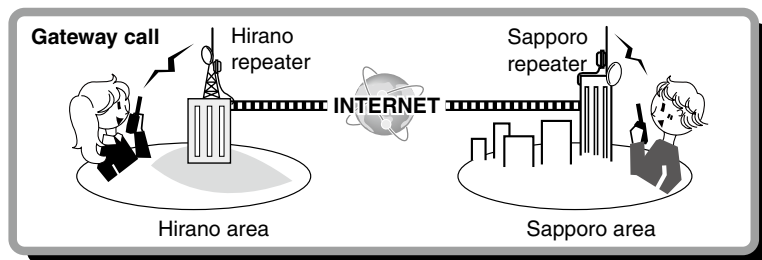

To call through your local area (access) repeater, repeater gateway and the internet to your destination repeater or individual station's last used repeater, using call sign routing.

#### NOTE:

- Using the repeater list is required to use the DR function. (p. 69)
- Before operating in the duplex mode, be sure to check whether the repeater is busy, or not. If the repeater is busy, wait until it is clear, or ask for a “break” using a method acceptable to your local procedures.
- The transceiver has a Time-Out Timer function for DV operation. The timer limits a continuous transmission. Warning beeps will sound approximately 30 seconds before time-out and then again immediately before time-out.

## ■ Making a Simplex call with the DR function

You can make a transceiver to transceiver call (through no repeater) in the DR screen.

**NOTE:** Depending on the transceiver's version, the frequencies may be different. Check for acceptable frequencies for your operating area.

**TIP: What is a Simplex Call?**

A simplex call is a direct call to another station, not using a repeater.

Example: Making a simplex call on 433.450 MHz.

### 1. "FROM" (Simplex channel) setting

- ① Hold down **DR** for 1 second.
- ② Push D-pad(↑) to select "FROM," and then push D-pad(Ent).

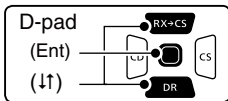

Go to step ③

- ③ Push D-pad(↓) to select "Repeater List," and then push D-pad(Ent).

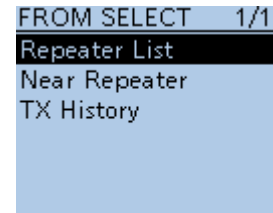

- ④ Push D-pad(↓) to select "20: Simplex," and then push D-pad(Ent).

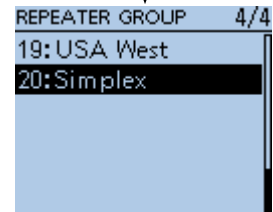

- ⑤ Push D-pad(↓) to select "433.450," and then push D-pad(Ent).

- "433.450" is displayed in "FROM."
- "CQCQCQ" is displayed in "TO." - If a station call sign is set in "TO", select "Local CQ" in the TO SELECT screen to set "TO" to "CQCQCQ."

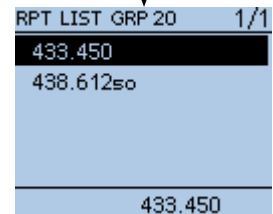

## 6 D-STAR OPERATION

### ■ Making a Simplex call (Continued)

#### 2. Hold down [PTT] to transmit

- ① While holding down [PTT], speak at your normal voice level.
  - The TX/RX indicator lights red.
  - The S/RF meter shows the transmit output power level.
- ② Release [PTT] to receive.



Transmitting

When you make a simplex call in the VFO mode, the LCD changes, as shown to the right.



**NOTE:** The simplex frequencies can be changed in the MENU screen. See the PDF type Advanced Manual section 9 for more details.

(MENU > DV memory > **Repeater List**)

### ■ Accessing repeaters

This section describes how to check whether or not you can access your local area repeater (Access repeater), and if your signal is successfully sent to a destination repeater.

**TIP:** If your call sign (MY) has not been set, or your call sign and equipment have not been registered at a D-STAR repeater, see pages 14 to 17.

#### 1. Select your Access repeater (“FROM”)

- ① Hold down [DR] for 1 second.
  - The repeater list, described in this manual, may differ from your transceiver’s preloaded list.

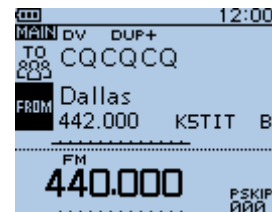

DR screen

- ② Push D-pad(↓) to select “FROM” (Access repeater), and then push D-pad(Ent).

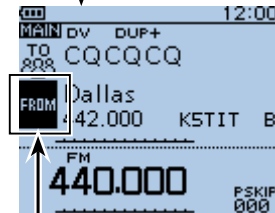
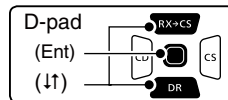

“FROM” is selected.

➡ Go to step ③

③ Push D-pad(↓) to select “Repeater List,” and then push D-pad(Ent).

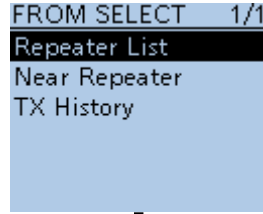

④ Push D-pad(↓) to select the repeater group where your access repeater is listed, and then push D-pad(Ent).  
 • Example: “11: Japan”



⑤ Push D-pad(↓) to select your access repeater, and then push D-pad(Ent).  
 • Example: “Hirano”

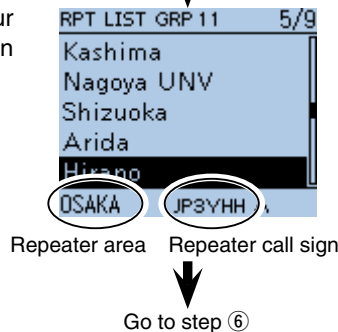

⑥ If the selected repeater name is displayed in “FROM” on the DR screen, the access repeater setting is completed.

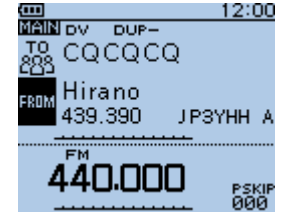

Completed

**NOTE:** See page 61 for status indications after a repeater system reply is received.

**TIP:**

- You have four other ways to select your access repeater, other than selecting it from repeater list. See the Advanced Manual for more details.
  - Rotating [DIAL]
  - Searching for the nearest repeaters
  - Selecting from the TX History
  - Searching for a repeater using the DR scan
- When you select just the repeater name, the repeater call sign, its frequency, duplex setting, frequency offset and Gateway call sign are automatically set.
- The repeater list, described in this manual, may differ from your transceiver’s programmed list.

## 6 D-STAR OPERATION

### ■ Accessing repeaters (Continued)

#### 2. Select the Destination repeater (“TO”)

Example: Your destination repeater is Hamacho/Japan in the repeater list.

- ① Push D-pad(↑) to select “TO” (Destination repeater), and then push D-pad(Ent).

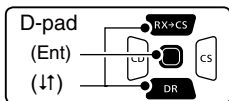

“TO” is selected.

- ② Push D-pad(↓) to select select “Gateway CQ,” and then push D-pad(Ent).

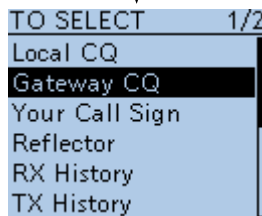

Go to step ③

- ③ Push D-pad(↓) to select the repeater group where your destination repeater is listed, and then push D-pad(Ent).
  - Example: “11: Japan”



- ④ Push D-pad(↓) to select your destination repeater, and then push D-pad(Ent).
  - Example: “Hamacho”

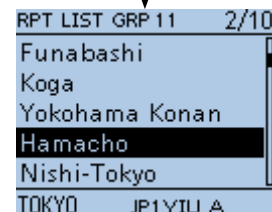

- ⑤ If the selected repeater name is displayed in “TO” on the DR screen, the destination repeater setting is completed.



Completed



### 3. Check whether you can access the repeater

- ① Hold down [PTT] for approximately 1 second to access the repeater.

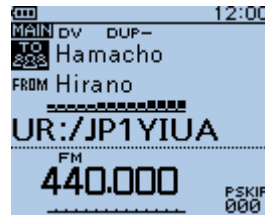

Transmitting

- ② If you get a reply call, or "UR?" appears on the LCD within 3 seconds, your signal reached your access repeater and your call was successfully sent from your destination repeater.

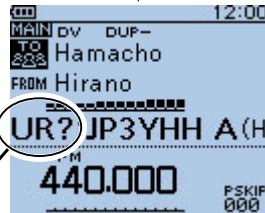

UR?:JP3YHH A(H)

Successfully sent!

**NOTE:** See page 61 for status indications after a reply is received.

## ■ Using the RX history

When a DV call is received, the call signs of the caller, the called station and the called station's access repeater are stored in the RX history file.

Up to 50 calls can be stored.

This section describes how to view the RX history screen and how to save the call sign to memory.

When receiving a call from "JM1ZLK:"



The S-meter appears and the caller's call sign is displayed.

☞ Continued on the next page

## 6 D-STAR OPERATION

### ■ Using the RX history (Continued)

#### 1. To display a received call sign

- Hold down **[CD]** for 1 second.
  - Displays the RX HISTORY screen.

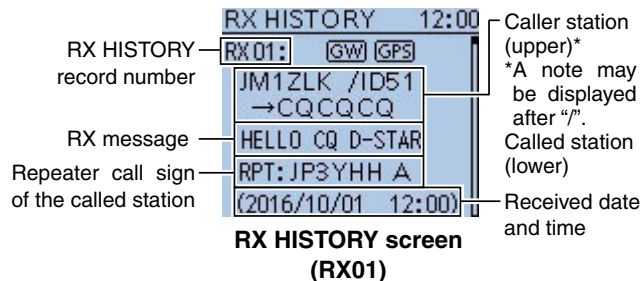

- Push D-pad(**↑**) to view other RX history.

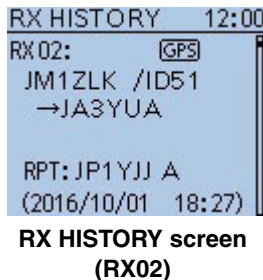
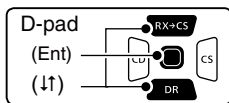

**NOTE:** If you push D-pad(Ent) in the RX HISTORY screen, you can check the detailed contents of the RX history.

#### 2. Save the destination call sign into your call sign memory from RX History

- Push D-pad(**↑**) to select the RX HISTORY record with the call sign that you want to save to memory.

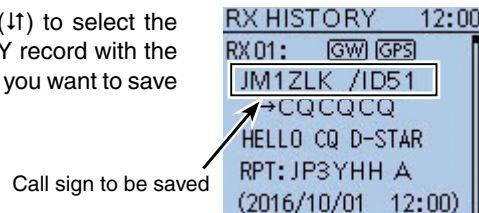

- Push D-pad(Ent), and then push **[QUICK]** **[QUICK]**.

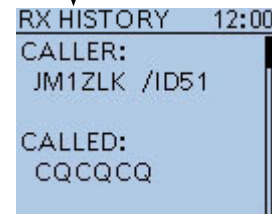

- Push D-pad(**↑**) to select “To Your Memory,” and then push D-pad(Ent).

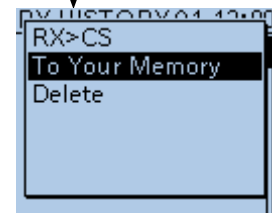
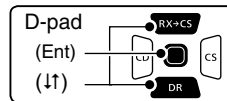

➡ Go to step ④

- ④ Push D-pad(↑) to select the call sign that you want to save, and then push D-pad(Ent).  
 • Example: “JM1ZLK”

**TIP:** The display changes to the YOUR CALL SIGN EDIT screen, and then the call sign is automatically saved.

- ⑤ Push D-pad(↑) to select “NAME,” and then push D-pad(Ent).  
 • A cursor appears and blinks.

- ⑥ Rotate [DIAL] to select a desired character to enter a name of up to 16 characters, including spaces.

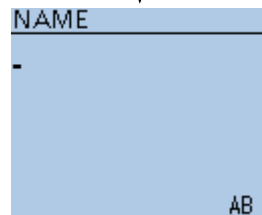
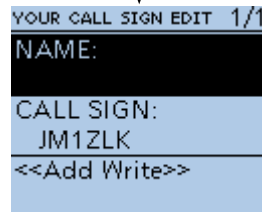

Go to step ⑦

**About text entry**

- Push D-pad(←) to move the cursor backward or forward.
- While selecting a character, push [QUICK]<sup>[QUICK]</sup>[SPCH]<sup>[SPCH]</sup> to change the character to an upper case or lower case letter.
- While selecting a digit, push [QUICK]<sup>[QUICK]</sup>[SPCH]<sup>[SPCH]</sup> to open the input mode selection window.
  - Push D-pad(↑←) to select the desired Upper case letters, Lower case letters, Numbers or Symbols.
  - To enter symbols, select “!”, “#,” and then push D-pad(Ent) to open the symbol character selection window. And rotate [DIAL] to select the desired symbol character, and then push D-pad(Ent).
- A space can be selected, in any input mode selected.
- Move the cursor, then rotate [DIAL] to insert a character.
- Rotate [DIAL] counterclockwise to enter a space.
- If you make a mistake, push [CLR]<sup>[CLR]</sup>[M<sup>[M]</sup>Hz]<sup>[LOW]</sup> to delete the selected character, symbol or number, or hold down [CLR] to continuously erase the characters, first to the right, and then to the left of the cursor.

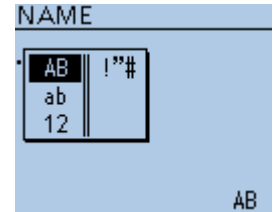

**Input mode selection window**

➡ Continued on the next page

## 6 D-STAR OPERATION

### ■ Using the RX history (Continued)

- ⑦ After entering the name, push D-pad(Ent).  
• Example: "TOM"

```
YOUR CALL SIGN EDIT 1/1
NAME:
TOM
CALL SIGN:
JM1ZLK
<<Add Write>>
```

- ⑧ Push D-pad(↑) to select "<<Add Write>>," and then push D-pad(Ent).

```
YOUR CALL SIGN EDIT 1/1
NAME:
TOM
CALL SIGN:
JM1ZLK
<<Add Write>>
```

- ⑨ Push D-pad(↑) to select "YES," and then push D-pad(Ent).

```
YOUR CALL SIGN EDIT 1/1
NAME:
Add write?
YES
NO
```

Completed

**TIP:** The saved call sign is displayed on the YOUR CALL SIGN screen as a selectable destination.

```
MENU 2/4
Call Sign
RX History
DV Memory
My Station
```

```
DV MEMORY 1/1
Your Call Sign
Repeater List
```

```
YOUR CALL SIGN 7/7
MARY
RICKY
TOM
JM1ZLK
```

"TOM" is added →

Shows TOM's call sign → JM1ZLK

## ■ Capturing a call sign

After you receive a repeater's signal, the calling station's call sign can be captured by touching the Call Sign Capture key (RX>CS) for 1 second. After releasing, you can quickly and easily reply to the call.

**TIP:** To capture the calling station's call sign after releasing the key, set the "[RX>CS] Key" item to "Call Sign Capture." (MENU > DV Set > [RX>CS] Key) (p. 26)

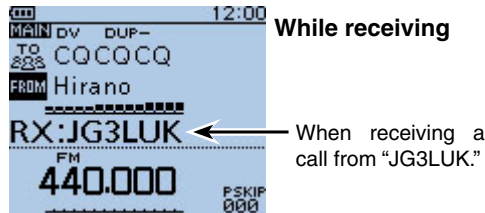

**TIP: What is the Call Sign Capture key?**  
Touching the Call Sign Capture key for 1 second sets the last received station's call sign as a temporary destination, and makes replying quick and easy.

The Call Sign Capture key is here!

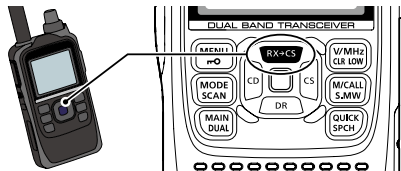

### 1. Set the received call sign to the destination

Hold down [RX>CS] for 1 second.

- After releasing, beeps sound, and the station call sign is announced.

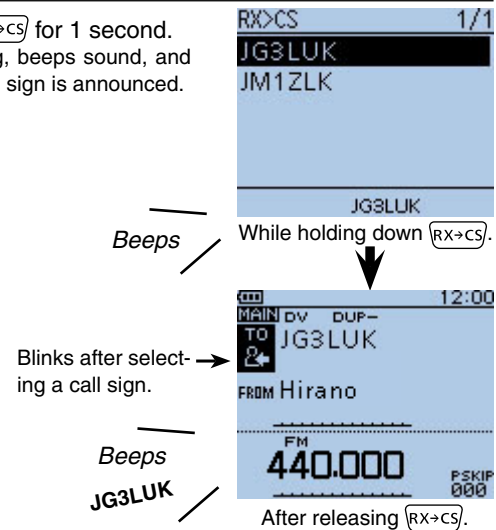

**NOTE:**

- If you want to select another call sign in the RX history, rotate [DIAL] while holding down [RX>CS].
- When the "[RX>CS] Key" item is set to "RX>CS List," the call sign is not set to the destination even after releasing the key. To set to the destination, select the call sign from the displayed list, and then push D-pad(Ent).

Continued on the next page

## 6 D-STAR OPERATION

### ■ Capturing a call sign (Continued)

**NOTE:** When a received signal is weak, DR scanning or the power save is ON, the call sign may not be received correctly. In that case, “-----” appears, an error beep sounds, and a quick reply call cannot be made.

### 2. Hold down [PTT] to transmit

- ① While holding down [PTT], speak at your normal voice level.



Transmitting

- ② Push [RX+CS] or [CLR] (V/MHz CLR LOW) to return to the previous call sign setting.



Return to the previous screen

## ■ Making a Local area call

A Local area call can be made when “Local CQ” is used to set “CQCQCQ” in “TO” (Destination).

### TIP: What is a Local Area Call?

To call through your local area (access) repeater.

### 1. Set “FROM” (Access repeater)

- ① Push D-pad(↑) to select “FROM,” and then push D-pad(Ent).

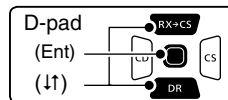

- ② Push D-pad(↑) to select “Repeater List,” and then push D-pad(Ent).

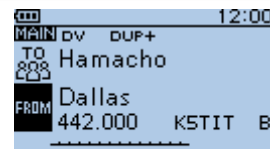

- ③ Push D-pad(↑) to select the repeater group where your access repeater is listed, and then push D-pad(Ent).
  - Example: “11: Japan”

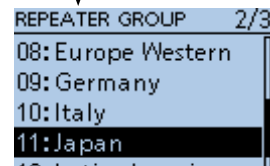

➡ Go to step ④

- ④ Push D-pad(↓) to select your access repeater, and then push D-pad(Ent).  
 • Example: “Hirano”



**2. Set “TO” (Destination)**

- ① Push D-pad(↑) to select “TO,” and then push D-pad(Ent).

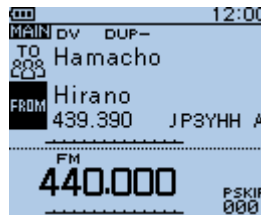
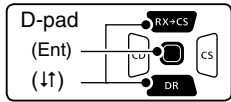

- ② Push D-pad(↓) to select “Local CQ,” and then push D-pad(Ent).  
 • “CQCQCQ” is set in “TO.”

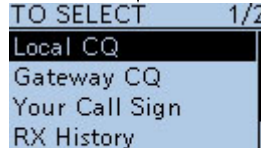

**TIP:** The Local CQ call is used to call anyone, but you can call a specific station by simply saying their call sign.

**3. Hold down [PTT] to transmit**

While holding down [PTT], speak at your normal voice level.

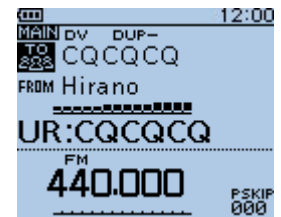

Transmitting

## 6 D-STAR OPERATION

### ■ Making a Gateway Repeater call

A Gateway call can be made when a destination repeater is selected in "TO" (Destination).

#### TIP: What is a Gateway Repeater Call?

To call through your local area (access) repeater, repeater gateway, and the Internet to your desired destination repeater.

#### 1. Set "FROM" (Access repeater)

- ① Push D-pad(↓) to select "FROM," and then push D-pad(Ent).

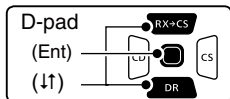

- ② Push D-pad(↓) to select "Repeater List," and then push D-pad(Ent).

- ③ Push D-pad(↓) to select the repeater group where your access repeater is listed, and then push D-pad(Ent).
  - Example: "11: Japan"

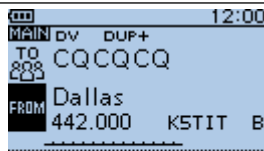

➡ Go to step ④

- ④ Push D-pad(↑) to select your access repeater, and then push D-pad(Ent).
  - Example: "Hirano430"



#### 2. Set "TO" (Destination)

- ① Push D-pad(↑) to select "TO," and then push D-pad(Ent).

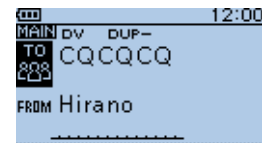

- ② Push D-pad(↓) to select "Gateway CQ," and then push D-pad(Ent).

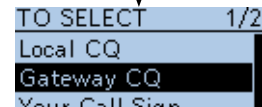

➡ Go to step ③



- ③ Push D-pad(↓) to select the repeater group where your destination repeater is listed, and then push D-pad(Ent).
  - Example: “11: Japan”

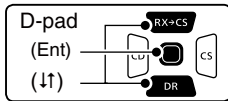

- ④ Push D-pad(↓) to select the destination repeater, and then push D-pad(Ent).
  - Example: “Hamacho430”



**3. Hold down [PTT] to transmit**

While holding down [PTT], speak at your normal voice level.

- “r” is automatically inserted to show it is a repeater call sign.

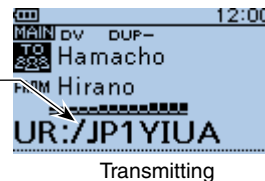

**TIP:** The Gateway CQ call is used to call any repeater, but you can call a specific station by simply saying their call sign.

**■ Calling an individual station**

You can make a call to an individual station when the station call sign is selected in “TO” (Destination).

When you call an individual station call sign through a gateway, your call is automatically sent to the last repeater that the station accessed. So, even if you don’t know where the station is, you can make a call using call sign routing.

**1. Set “FROM” (Access repeater)**

- ① Push D-pad(↓) to select “FROM,” and then push D-pad(Ent).

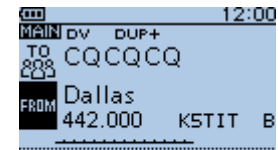

- ② Push D-pad(↓) to select “Repeater List,” and then push D-pad(Ent).



- ③ Push D-pad(↓) to select the repeater group where your access repeater is listed, and then push D-pad(Ent).
  - Example: “11: Japan”



Go to step ④

☞ Continued on the next page

## 6 D-STAR OPERATION

### ■ Calling an individual station (Continued)

- ④ Push D-pad(↑) to select your access repeater, and then push D-pad(Ent).  
• Example: "Hirano430"



- ③ Push D-pad(↑) to select the destination station, and then push D-pad(Ent).  
• Example: "TOM"

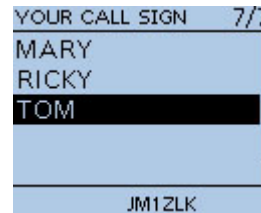

### 2. Set "TO" (Destination)

- ① Push D-pad(↑) to select "TO," and then push D-pad(Ent).



- ② Push D-pad(↑) to select "Your Call Sign," and then push D-pad(Ent).

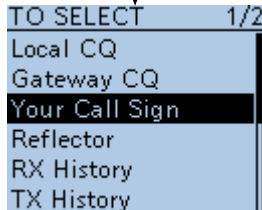

Go to step ③

### 3. Hold down [PTT] to transmit



While holding down [PTT], speak at your normal voice level.



Transmitting

## ■ Troubleshooting

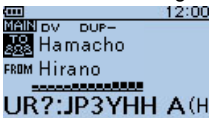



To communicate through the repeater, your signal must access to the repeater. When your signal accesses your local repeater, but it is not sent to the destination repeater, the repeater replies with an status message.

PROBLEM	POSSIBLE CAUSE	SOLUTION	REF.
<p>After your call, the repeater does not return a status reply.</p>	<ul style="list-style-type: none"> <li>• The repeater setting is wrong.</li> <li>• Your transmission did not reach the repeater.</li> </ul>	<ul style="list-style-type: none"> <li>• Select the correct repeater.</li> <li>• Correct the repeater frequency, frequency offset, or duplex settings.</li> <li>• Wait until you are closer to the repeater and try again.</li> <li>• Try to access another repeater.</li> </ul>	<p>p. 48 —</p>
<p>After your call, the repeater replies 'UR?' and its call sign.</p> 	<ul style="list-style-type: none"> <li>• The call was successfully sent, but no station immediately replied.</li> </ul>	<ul style="list-style-type: none"> <li>• Wait for a while, and try again.</li> </ul>	<p>—</p>
<p>After your call, the repeater replies 'RX' or 'RPT?' and the access repeater's call sign.</p> 	<ul style="list-style-type: none"> <li>• Your own call sign (MY) has not been set.</li> <li>• Your own call sign (MY) has not been registered on a gateway repeater, or the registered contents do not match your transceiver's setting.</li> </ul>	<ul style="list-style-type: none"> <li>• Set your own call sign (MY).</li> <li>• Register your own call sign (MY) on a gateway repeater, or confirm the registration of the call sign.</li> </ul>	<p>p. 14 p. 16</p>
<p>After your call, the repeater replies 'RPT?' and call sign of the destination repeater.</p>	<ul style="list-style-type: none"> <li>• The repeater cannot connect to the destination repeater.</li> <li>• The repeater is busy.</li> </ul>	<ul style="list-style-type: none"> <li>• Check the repeater setting.</li> <li>• Wait for a while, and try it again.</li> </ul>	<p>p. 58 —</p>

☞ Continued on the next page

## 6 D-STAR OPERATION

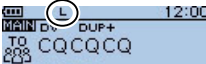
### ■ Troubleshooting (Continued)

PROBLEM	POSSIBLE CAUSE	SOLUTION	REF.
After your call, the access repeater replies 'RPT?' and its call sign.	<ul style="list-style-type: none"> <li>The call sign of the destination repeater is wrong.</li> </ul>	<ul style="list-style-type: none"> <li>Correctly set the destination repeater call sign.</li> </ul>	—
Even holding down  , the DR screen will not appear.	<ul style="list-style-type: none"> <li>There is no repeater list in your transceiver.</li> </ul>	<ul style="list-style-type: none"> <li>Reload the repeater list using the CS-51PLUS2 CLONING SOFTWARE on the CD or from a microSD backup card.</li> <li>Enter the Repeater list data directly into the transceiver.</li> </ul>	Sec. 17 of AM*  Sec. 9 of AM*
Even holding down  , the received call sign will not set to the destination call sign.	<ul style="list-style-type: none"> <li>The call sign has not been correctly received.</li> <li>When a received signal is weak, or a signal is received during scanning, the call sign may not be received correctly. In that case, "-----" appears and error beeps sound, and a reply call cannot be made.</li> </ul>	<ul style="list-style-type: none"> <li>Try it again, after the transceiver has correctly received the call sign.</li> </ul>	—
A Local area call can be made, but the Gateway call or destination station call cannot be made.	<ul style="list-style-type: none"> <li>MY call sign has not been registered on a D-STAR repeater.</li> </ul>	<ul style="list-style-type: none"> <li>Register your own call sign (MY) on a gateway repeater, or confirm the registration of the call sign.</li> </ul>	p. 16
Position data cannot be received or displayed.	<ul style="list-style-type: none"> <li>"External GPS" is selected in the GPS Set item on the Menu screen, but an external GPS receiver is not connected.</li> <li>"OFF" or "Manual" is selected in the GPS Set item on the Menu screen.</li> <li>A GPS signal was not received.</li> </ul>	<ul style="list-style-type: none"> <li>Connect an external GPS receiver.</li> <li>Select either "Internal GPS" or "External GPS" in the GPS Set item on the Menu screen.</li> <li>Move until the GPS signal is received.</li> </ul>	
"L" appears on the LCD. 	<ul style="list-style-type: none"> <li>While receiving through the internet, some packets may be lost due to network error (poor data throughput performance).</li> </ul>	<ul style="list-style-type: none"> <li>Wait a while, and try it again.</li> <li> When the transceiver receives corrupted data, and misidentifies it as Packet Loss, "L" is displayed, even if it is a Local area call.</li> </ul>	—
"DV" and "FM" icons alternately blink.	<ul style="list-style-type: none"> <li>While in the DV mode, an FM signal is received.</li> </ul>	<ul style="list-style-type: none"> <li>Use a different operating frequency until there are no FM signals on the original frequency.</li> </ul>	—

\* "AM" indicates the PDF type Advanced Manual.

## ■ Reflector operation

### ◇ What is the reflector?

A reflector is a special server connected to the internet and running a version of dplus software. If the dplus software is installed on your access repeater, it provides various functions including gateway and reflector linking capabilities (It is known as the D-STAR reflector system). The D-STAR reflector system enables a number of D-STAR repeaters around the world to link to a reflector. This means that when you transmit through a D-STAR repeater linked to a reflector, your voice can be heard on other repeaters linked to the reflector, and you can hear other stations that are connected to the reflector.

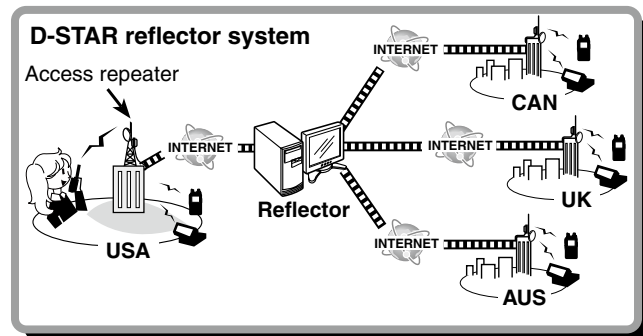

### ◇ Linking to a reflector

If your repeater is not currently linked to a reflector, or you want to change to another reflector, you can do so following the steps below. Before linking to another reflector, be sure to unlink the current reflector. (p. 66)

#### Direct inputting

**Example:** Directly enter "REF010BL."

- ① Hold down **DR** for 1 second.
- ② Push D-pad(↑) to select "TO," and then push D-pad(Ent).

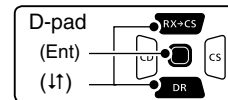

- ③ Push D-pad(↑) to select "Reflector," and then push D-pad(Ent).
  - The "REFLECTOR" screen appears.

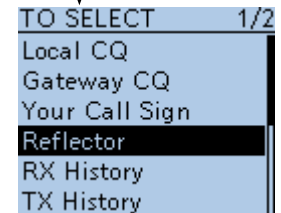

➔ Go to step ④

➔ Continued on the next page

## 6 D-STAR OPERATION

### ■ Reflector operation

#### ◇ Linking to a reflector (Continued)

④ Push D-pad(↑) to select “Link to Reflector,” and then push D-pad(Ent).

⑤ Push D-pad(↑) to select “Direct Input,” and then push D-pad(Ent).

⑥ Push D-pad(↑) to select the reflector number.  
(Example: 010)

⑦ Push D-pad(→) to move the cursor.

⑧ Push D-pad(↑) to select module letter.  
(Example: B).

⑨ Push D-pad(Ent).  
• The transceiver returns to the DR screen.

• “Link to Reflector” and “REF010BL” are displayed in “TO.”

⑩ Hold down [PTT] to link to the reflector.  
• The TX/RX indicator lights red.

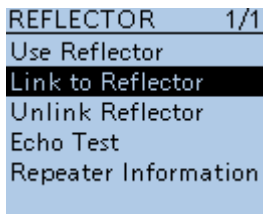

```
REFLECTOR 1/1
Use Reflector
Link to Reflector
Unlink Reflector
Echo Test
Repeater Information
```

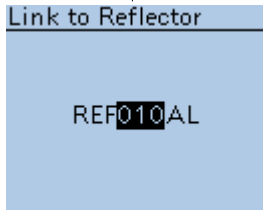

```
Link to Reflector
REF010AL
```

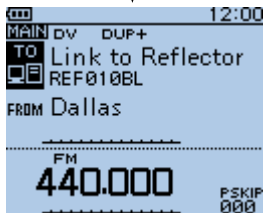

```
12:00
MAIN DV DUP+
TO Link to Reflector
REF010BL
FROM Dallas
FM 440.000 P.S.K.I.P. 000
```

### Using the TX History

The TX History stores up to 5 reflectors that your access repeater linked to before.

**Example:** Select the “REF002AL” in the TX History.

① Hold down  for 1 second.

② Push D-pad(↑) to select “TO,” and then push D-pad(Ent).

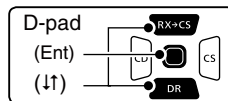

③ Push D-pad(↑) to select “Reflector,” and then push D-pad(Ent).  
• The “REFLECTOR” screen appears.

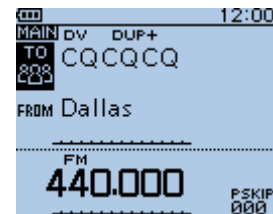

```
12:00
MAIN DV DUP+
TO CQ CQ CQ
888
FROM Dallas
FM 440.000 P.S.K.I.P. 000
```

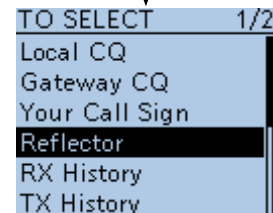

```
TO SELECT 1/2
Local CQ
Gateway CQ
Your Call Sign
Reflector
RX History
TX History
```

Go to step ④

- ④ Push D-pad(↓) to select “Link to Reflector,” and then push D-pad(Ent).

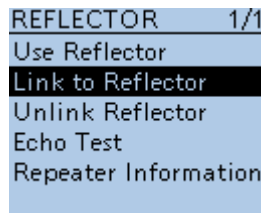

- ⑤ Push D-pad(↓) to select the reflector that you want to link to.  
(Example: “REF002AL”)

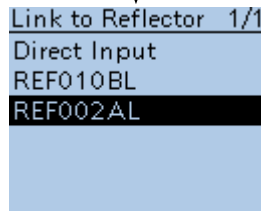

- ⑥ Push D-pad(Ent).  
• The transceiver returns to the DR screen.  
• “Link to Reflector” and “REF002AL” are displayed in “TO.”
- ⑦ Hold down [PTT] to link to the reflector.  
• The TX/RX indicator lights red.

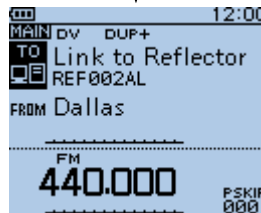

### ◇ Using a reflector

- ① Hold down [DR] for 1 second.
- ② Push D-pad(↓) to select “TO,” and then push D-pad(Ent).

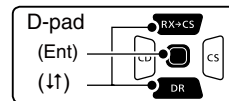

- ③ Push D-pad(↓) to select “Reflector,” and then push D-pad(Ent).  
• The “REFLECTOR” screen appears.

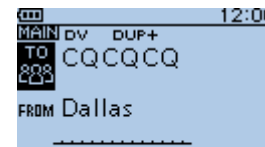

- ④ Push D-pad(↓) to select “Use Reflector.”

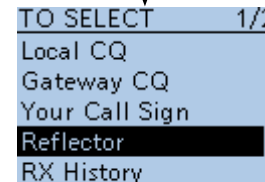

- ⑤ Push D-pad(Ent).  
• The transceiver returns to the DR screen.  
• “Use Reflector” and “CQCQCQ” are displayed in “TO.”
- ⑥ Hold down [PTT] to link to the reflector.  
• The TX/RX indicator lights red.

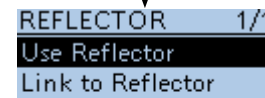

## 6 D-STAR OPERATION

### ■ Reflector operation (Continued)

#### ◇ Unlinking a reflector

Before linking to another reflector, be sure to unlink the current reflector.

- ① Hold down **[DR]** for 1 second.
- ② Push **D-pad(↑)** to select “TO,” and then push **D-pad(Ent)**.

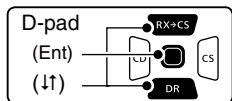

- ③ Push **D-pad(↑)** to select “Reflector,” and then push **D-pad(Ent)**.
  - The “REFLECTOR” screen appears.

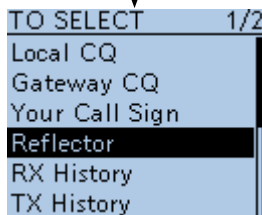
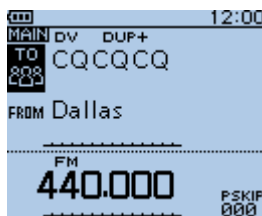

Go to step ④

- ④ Push **D-pad(↑)** to select “Unlink Reflector.”

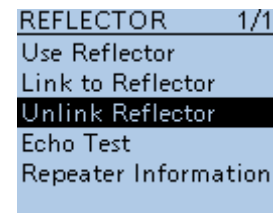

- ⑤ Push **D-pad(Ent)**.
  - The transceiver returns to the DR screen.
  - “Unlink Reflector” and “U” are displayed in “TO.”
- ⑥ Hold down **[PTT]** to unlink the reflector.
  - The TX/RX indicator lights red.

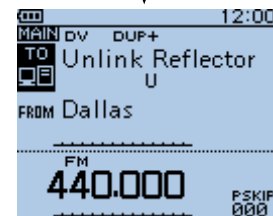



### ◇ Reflector Echo Testing

You can transmit a short message, and after releasing [PTT], your message will be played back. It is a useful check of how well your signal is getting into the repeater, and you can use it to verify that your repeater is operating normally.

- ① Hold down **DR** for 1 second.
- ② Push D-pad(↑) to select "TO," and then push D-pad(Ent).

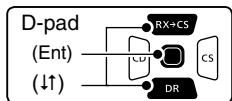

- ③ Push D-pad(↑) to select "Reflector," and then push D-pad(Ent).
  - The "REFLECTOR" screen appears.

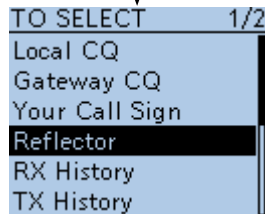
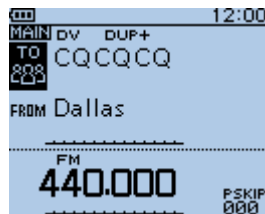

Go to step ④

- ④ Push D-pad(↓) to select "Echo Test."

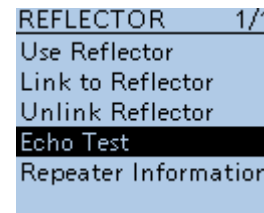

- ⑤ Push D-pad(Ent).
  - The transceiver returns to the DR screen.
  - "Echo Test" and "E" are displayed in "TO."
- ⑥ Hold down [PTT] and speak at normal voice level.
  - The TX/RX indicator lights red.
- ⑦ Release [PTT] to hear your message.

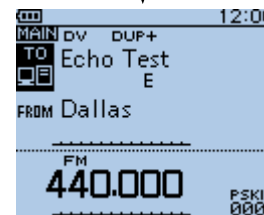

## 6 D-STAR OPERATION

### ■ Reflector operation (Continued)

#### ◇ Requesting repeater information

When you send the repeater information command, an ID message is sent back.

① Hold down  for 1 second.

② Push D-pad(↑) to select “TO,” and then push D-pad(Ent).

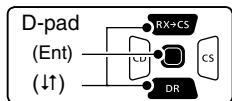

③ Push D-pad(↑) to select “Reflector,” and then push D-pad(Ent).

- The “REFLECTOR” screen appears.

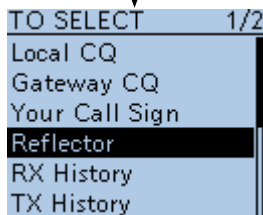
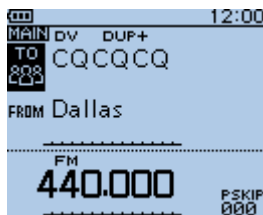

Go to step ④

④ Push D-pad(↓) to select “Repeater Information.”

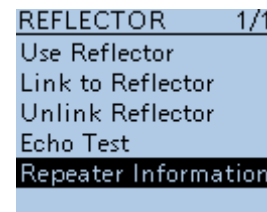

⑤ Push D-pad(Ent).

- The transceiver returns to the DR screen.
- “Repeater Information” and “I” are displayed in “TO.”

⑥ Hold down [PTT] to send the repeater information command.

- The TX/RX indicator lights red.

⑦ Release [PTT] to hear the repeater ID message.



## ■ Updating the repeater list

For easy operation, a repeater list is preloaded into your transceiver.

This section describes how to manually update the repeater list using a microSD card.

The latest setting files can be downloaded from the Icom website.

### 1. Downloading the latest setting file (ICF file)

① Access the following URL to download the latest data.  
<http://www.icom.co.jp/world/support/download/firm/index.html>

- The latest settings files (ICF file) and repeater list (CSV: Comma Separated Values file) are contained in the downloaded ZIP file.

**File Name:** 51P2\_USA\_160913.zip

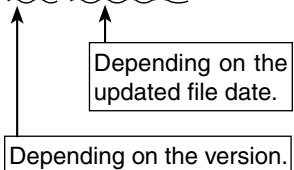

**TIP:** This instruction manual describes when the file name is “51P2\_USA\_160913.zip,” for example.

ID-51A/E’s latest setting file is uploaded to “Cloning software(Rev. \*\* ) and manuals” in the Icom website screen.

- The displayed contents may differ.

Model name	Version	last update
IC-50AD	Firmware(Vers.1.12), Firmware Utility and manuals	2016/06/29
IC-E9000	Cloning software(Rev.1.10), address book and manuals	2016/07/04
ID-5804		
ID-E980	Cloning software(Rev.1.0) and manuals	2009/02/25
ID-51A PLUS		
ID-51A Icom Anniversary Limited Edition	Repeater List_GPS data and Setting Data(Vers.2014/07/25)	2014/09/22
ID-51E PLUS		
ID-51E Icom Anniversary Limited Edition	Repeater List_GPS data and Setting Data(Vers.2014/07/25)	2014/09/22

ID-51A ID-51E PLUS2	Cloning software(Rev. ** ) and manuals	20**/**/**
---------------------------	--	------------

② Decompress the compressed file that is downloaded from the Icom website.

“51P2\_USA\_160913” folder will be created on the same place where the downloaded file is saved.

## 6 D-STAR OPERATION

### ■ Updating the repeater list (Continued)

#### 2. Inserting the microSD card into a PC

- ③ Insert the microSD card into the microSD card drive on your PC.
- Icom recommends that you format all microSD cards to be used with the ID-51A/E, even preformatted microSD cards for PCs or other uses.

**TIP:** See pages 11, 76 and 77 for details of inserting and removing the microSD card.

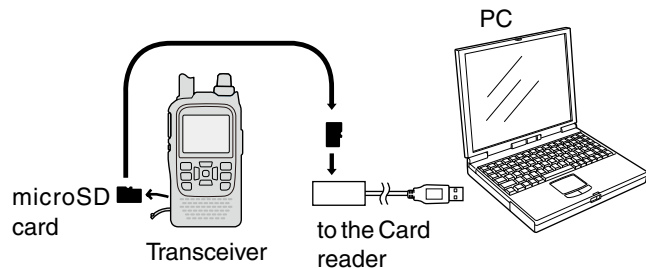

#### 3. Copying the latest ICF file to the microSD card

- ④ Double-click the “51P2\_USA\_160913” folder created on the same place where the downloaded file is saved.
- ⑤ Copy the ICF file (Example: “51P2\_USA\_160913.icf”) in the folder to the “Setting” folder in the “ID-51” folder of the microSD card.

**TIP:** You can copy one or more ICF files in the folder, but the transceiver loads only one file.

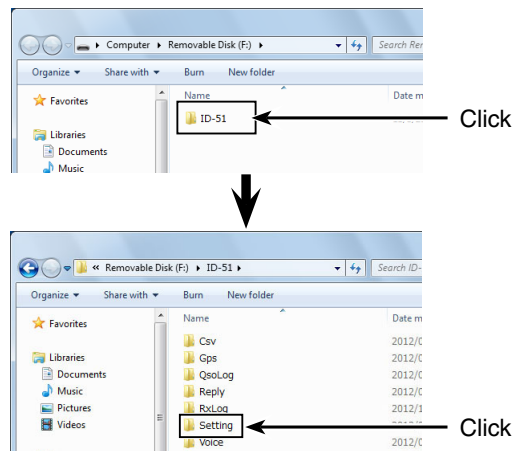

#### 4. Inserting the microSD card

- Remove the microSD card from the PC, and insert the card into the transceiver's slot.

**TIP:** See pages 11, 76 and 77 for details of inserting and removing the microSD card.

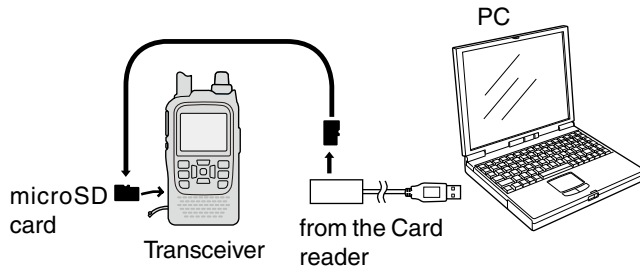

**TIP:** Saving the current data is recommended before loading other data into the transceiver.

#### 5. Updating the repeater list

- Push [MENU] .
- Push D-pad(↑) to select "Load Setting," and then push D-pad(Ent).

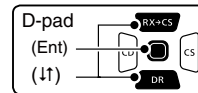

(SD Card > **Load Setting**)

- If the item is not displayed, push D-pad(↑) one or more times to select the page.
- Push D-pad(↑) to select the ICF file to be loaded, and then push D-pad(Ent).  
(**Example:** Selecting "51P2\_USA\_160913.icf")
    - The LOAD FILE screen appears.

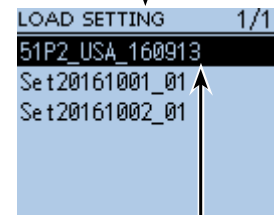
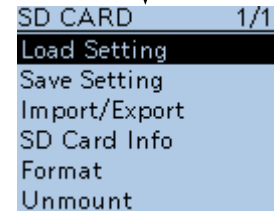
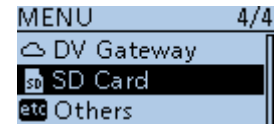

Select the file to be loaded

## 6 D-STAR OPERATION

### ■ Updating the repeater list (Continued)

10 Push D-pad(↑) to select “Repeater List Only,” and then push D-pad(Ent).

11 Push D-pad(Ent) to select the file, and then the “Keep ‘SKIP’ settings in Repeater List?” appears.

12 Push D-pad(↑) to select “YES” or “NO.”

- When “YES” is selected, the skip settings of the repeater list are retained.

13 Push D-pad(Ent), “Load file?” appears.

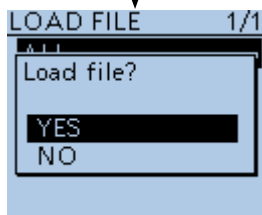
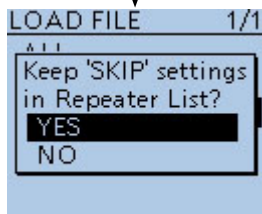
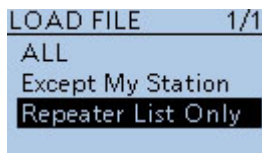

14 Push D-pad(1) to select “YES,” then push D-pad(Ent) to start the file check.

- While checking the file, “CHECKING FILE” and a progress bar are displayed.

15 After checking, settings data loading starts.

- While loading, “LOADING” and a progress bar are displayed.

16 After loading, “COMPLETED!” appears.

- To complete the loading process, reboot the transceiver.

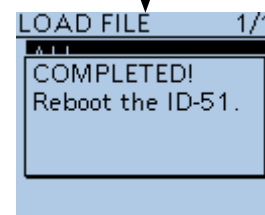
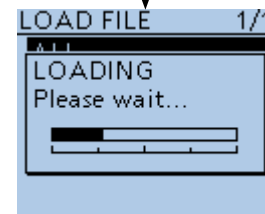
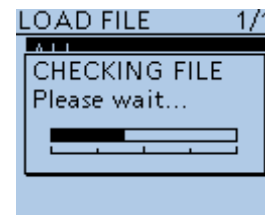

**Repeater list updating is complete!**

## ■ About the microSD card

**TIP:** The microSD and microSDHC cards are not available from Icom. Purchase separately.

A microSD card of up to 2 GB, or an microSDHC of up to 32 GB, can be used with the ID-51A/E.

Icom has checked the compatibility with the following microSD and microSDHC cards.

(As of September 2016)

Brand	Type	Memory size
SanDisk®	microSD	2 GB
	microSDHC	4 GB
		8 GB
		16 GB
		32 GB

- The performance of the cards listed above is not guaranteed.
- Throughout the rest of this document, the microSD card and an microSDHC card are simply called microSD cards.
- Icom recommends that you format all microSD cards to be used with the transceiver, even preformatted microSD cards for PCs or other uses.



### NOTE:

- Before using the microSD card, read the instructions of the microSD card thoroughly.
- If you do any of the following, the microSD card data may be corrupted or deleted.
  - You remove the microSD card from the transceiver while accessing the microSD card.
  - You change the external power supply's voltage while accessing the microSD card.
  - You start the vehicle engine while accessing the microSD card.
  - You drop, impact or vibrate the microSD card.
- Do not touch the contacts of the microSD card.
- The transceiver takes a longer time to recognize a high capacity microSD card.
- The microSD card will get warm if used continuously for a long period of time.
- The microSD card has a certain lifetime, so data reading or writing may not be possible after using it for a long time period.
- When reading or writing data is impossible, the microSD card's lifetime has ended. In this case, purchase a new one. We recommend you make a backup file of the important data onto your PC.
- Icom will not be responsible for any damage caused by data corruption of an microSD card.

## Recording a QSO audio

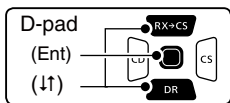
- 1 Push [QUICK]<sup>QUICK SPCH</sup> to enter the Quick Menu screen.
- 2 Push D-pad(↓) to select “<<REC Start>>.”



- 3 Push D-pad(Ent) to start voice recording.
  - The transceiver displays “Recording started” and automatically exits the Quick Menu screen.
  - “” appears while the transceiver is recording.
  - “” appears while the recording is paused.
  - Recording is continuous until you manually stop recording, or the card becomes full.
  - If the recording file’s content reaches 2GB, the transceiver automatically creates a new file, and continues recording.

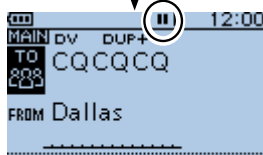
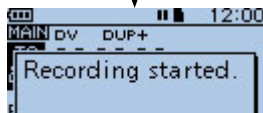
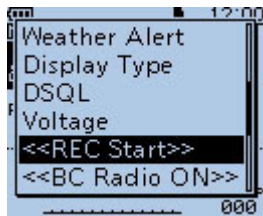

While pausing



While recording

**NOTE:** BC Radio audio cannot be recorded.

### ◆ To stop recording

- 1 Push [QUICK]<sup>QUICK SPCH</sup> to enter the Quick Menu screen.
- 2 Push D-pad(↓) to select “<<REC Stop>>.”



- 3 Push D-pad(Ent) to stop voice recording.
  - The transceiver displays “Recording stopped,” and automatically exits the Quick Menu screen.



**TIP:** When the PTT Automatic Recording function is set to ON in the MENU screen, the recording automatically starts when [PTT] is pushed. (p. 22)  
 (MENU > Voice Memo > QSO Recorder > Recorder Set > PTT Auto REC)



## ■ Playing recorded audio

- ① Push [MENU]  to enter the Menu screen.
- ② Push D-pad(↑) to select “Play Files,” and then push D-pad(Ent).

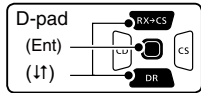

- (Voice Memo > QSO Recorder > **Play Files**)
- If the item is not displayed, push D-pad(↑) one or more times to select the page.

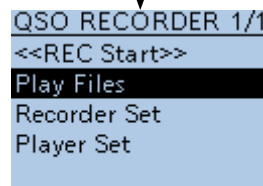
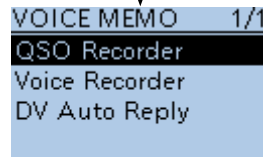
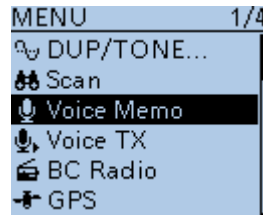

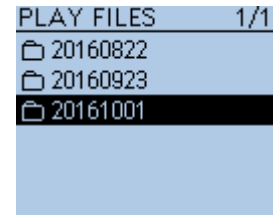

Go to step ④

- ③ Push D-pad(↓) to select the folder that contains the file you want to play, and then push D-pad(Ent).
  - The folder name is composed of the year (4 digits), the month and the day (2 digits each).

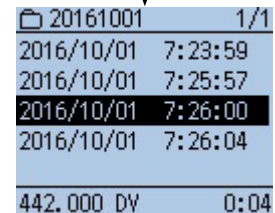

- ④ Push D-pad(↓) to select the file that you want to play, then push D-pad(Ent) to play it back.
  - The VOICE PLAYER screen is displayed, and the file starts to play back.



- ⑤ Push [MENU]  or [CLR] to stop the playback.
  - The file list is automatically displayed.

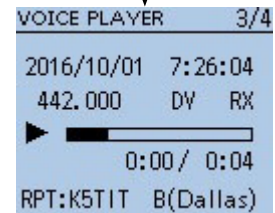

## ■ Removing the microSD card

### ◇ Removing the microSD card

- ① Turn OFF the power.
- ② Lift OFF the [micro SD] slot cover on the side panel.
- ③ Push in the microSD card until a click sounds, and then carefully pull it out.
  - **DO NOT** touch the terminals.
- ④ Completely close the [micro SD] slot cover.

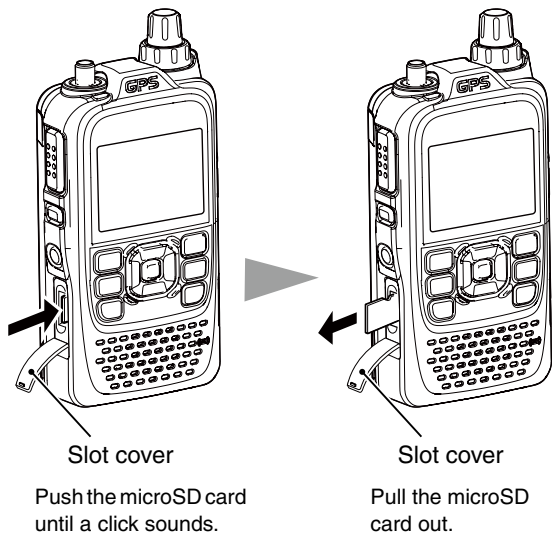

**NOTE:** After a microSD card is inserted, completely close the [micro SD] slot cover as shown to the right.

Close the cover, leaving no gap.

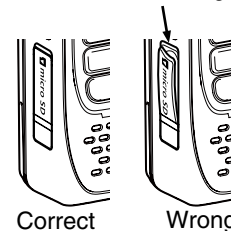

### ◇ Removing the microSD card while the transceiver's power is ON

If removing the microSD card while the transceiver's power is ON, by doing the following steps.

- ① Push [MENU] .
- ② Push D-pad(↓) to select "SD Card," then push D-pad(Ent).

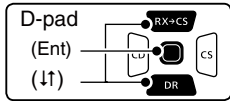

- ③ Push D-pad(↓) to select "Unmount," and then push D-pad(Ent).
  - The confirmation screen "Unmount OK?" appears.

- ④ Push D-pad(→) to select "YES," then push D-pad(Ent) to unmount.

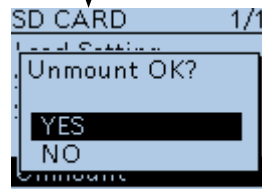
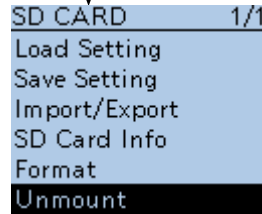
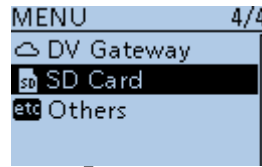

➡ Go to step ⑤

- ⑤ When the unmounting is completed, "Unmount is completed." is displayed, then the screen automatically returns to the MENU screen.
- ⑥ Push [MENU]  to exit the MENU screen.
- ⑦ Lift OFF the [micro SD] slot cover on the side panel.
- ⑧ Push in the microSD card until a click sounds, and then carefully pull it out.
  - **DO NOT** touch the terminals.
- ⑨ Completely close the [micro SD] slot cover.



## ■ GPS operation

The ID-51A/E has a built-in internal GPS receiver. You can check your current position and time.

### ◇ GPS receive setting

Check whether or not the GPS receiver is receiving your position and time.

The GPS icon blinks when searching for satellites.



The GPS icon stops blinking when the minimum number of needed satellites are found.



- It may take only a few seconds to calculate your position. But depending on the environment, it may take a few minutes. If you have difficulties receiving, we recommend that you try a different location.
- When the “GPS Select” item is set to “Manual,” the icon does not appear.  
(GPS > GPS Set > **GPS Select**)

## ■ Checking your GPS position

You can check your current position.

If you transmit while displaying the GPS position screen, the screen closes.

But you can check your current position, RX position, and so on by touching the GPS icon while transmitting.

### ◇ Displaying Position Data

Confirm the GPS icon is displayed on the LCD.



- ① Push [QUICK] <sup>[QUICK]</sup> <sub>[SPCH]</sub>.
- ② Push D-pad(↑) to select the “GPS position” item, and then push D-pad(Ent).

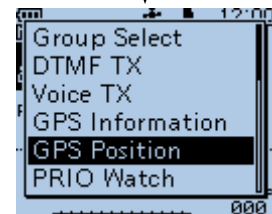
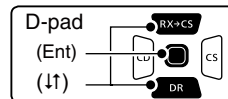

Go to step ③

③ The first MY GPS position screen appears. (1/5)

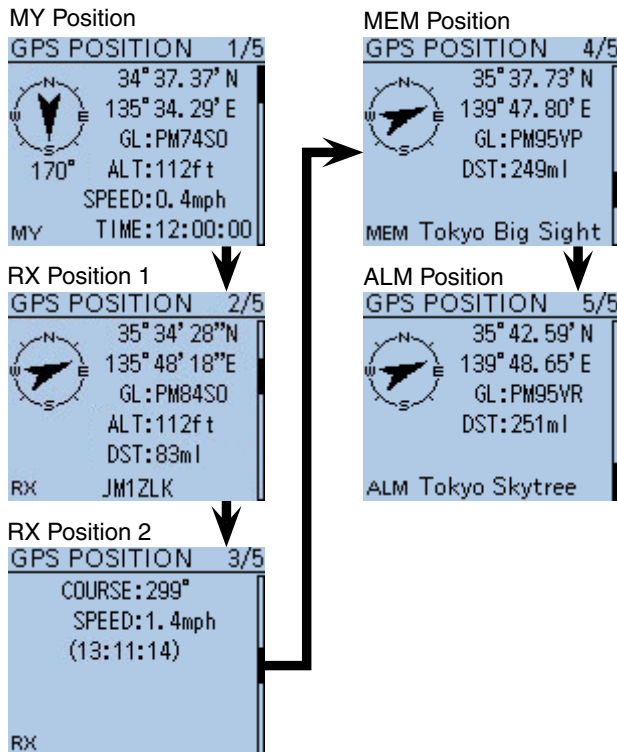

④ Push [CLR] to close the GPS Position screen.

<Contents of the GPS Position screen>

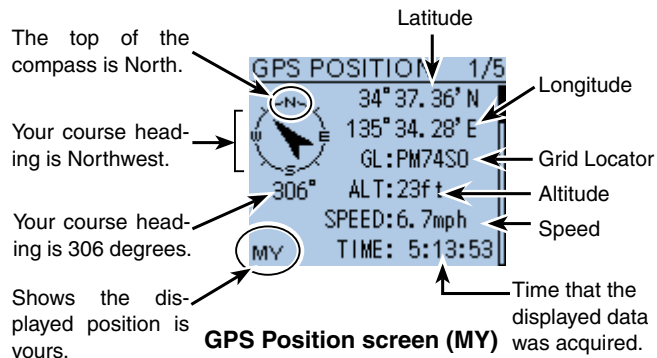

## ■ GPS Logger function

The GPS Logger function allows you to store the GPS position data (Latitude, Longitude, Altitude, Positioning state, Course, Speed and Date) onto a microSD card, as a route. If you use this function while driving, you can check your driving course on a mapping software. (Default setting is ON.)

**NOTE:** The GPS logger function requires a microSD card installation.

- See page 11 for more details.

### <About log file>

You can display your route as you move, if you import the log file into a mapping software.

- You can see your route on the software map. The files may not be compatible with all mapping software.
- See the PDF type Advanced Manual for copying the log file to your PC.

### NOTE:

- This function is ON as the default setting, if you install a microSD card, the transceiver continuously stores the position data from the GPS receiver, even if the transceiver is rebooted. To cancel this function, turn the function OFF. While this function is ON, and when the transceiver is turned OFF, the log file will be closed. Then the transceiver is turned ON and positioning is carried out by the GPS receiver, a new log file will be created.
- When the microSD card is full, this function will automatically pause.

### Turning OFF the GPS Logger function

If you do not use this function, turn OFF the function as following procedures.

- ① Push [MENU]  to enter the Menu screen.
- ② Push D-pad(↑) to select "GPS Logger," and then push D-pad(Ent).  
(GPS > GPS Logger >

#### GPS Logger

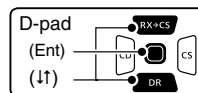

- If the item is not displayed, push D-pad(↑) one or more times to select the page.

- ③ Push D-pad(↓) to select "OFF"
- ④ Push [MENU]  to exit the Menu screen.
  - The GPS Logger cancels.

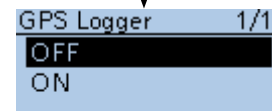
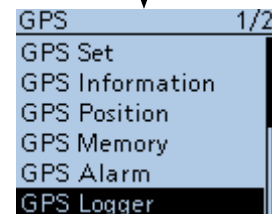
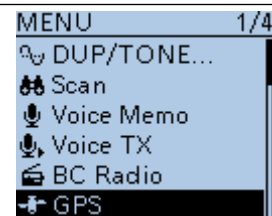

## ■ Resetting

The display may occasionally display erroneous information. This may be caused externally by static electricity or by other factors. If this problem occurs, turn OFF power. After waiting a few seconds, turn ON power again. If the problem persists, perform a Partial reset or an All reset.

**BE CAREFUL!** An All reset clears all programming and returns all settings to their factory defaults. See the PDF type Advanced Manual for more details.

A Partial reset resets operating settings to their default values (VFO frequency, VFO settings, menu contents) without clearing the items below:

- Memory channel contents
- Call channel contents
- Message data
- GPS Memory contents
- BC Radio Memory
- Scan Edge contents
- Call sign memories
- DTMF memory contents
- Repeater list

### ◇ Partial reset

- ① Push [MENU]  to enter the Menu screen.
- ② Push D-pad(↑) to select “Partial Reset,” and then push D-pad(Ent).

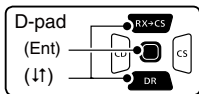

- (Others > Reset > Partial Reset)
- If the item is not displayed, push D-pad(↑) one or more times to select the page.

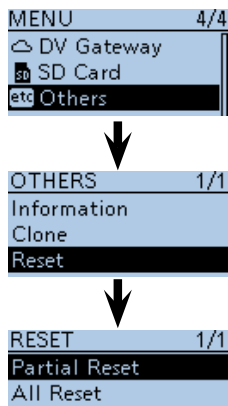

Go to step ④

- ③ The “Partial Reset?” dialog appears.
- ④ Push D-pad(↑) to select “Yes,” and then push D-pad(Ent).
  - The transceiver displays “PARTIAL RESET,” then the partial reset is completed.

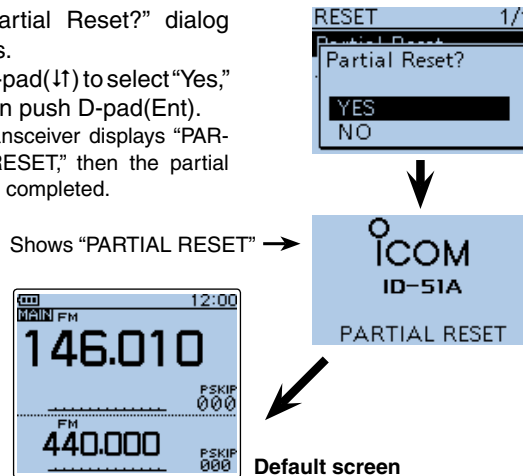

## COUNTRY CODE LIST

• ISO 3166-1

	Country	Codes		Country	Codes
1	Austria	AT	18	Liechtenstein	LI
2	Belgium	BE	19	Lithuania	LT
3	Bulgaria	BG	20	Luxembourg	LU
4	Croatia	HR	21	Malta	MT
5	Czech Republic	CZ	22	Netherlands	NL
6	Cyprus	CY	23	Norway	NO
7	Denmark	DK	24	Poland	PL
8	Estonia	EE	25	Portugal	PT
9	Finland	FI	26	Romania	RO
10	France	FR	27	Slovakia	SK
11	Germany	DE	28	Slovenia	SI
12	Greece	GR	29	Spain	ES
13	Hungary	HU	30	Sweden	SE
14	Iceland	IS	31	Switzerland	CH
15	Ireland	IE	32	Turkey	TR
16	Italy	IT	33	United Kingdom	GB
17	Latvia	LV			

## FCC INFORMATION

• **FOR CLASS B UNINTENTIONAL RADIATORS:**

This equipment has been tested and found to comply with the limits for a Class B digital device, pursuant to part 15 of the FCC Rules. These limits are designed to provide reasonable protection against harmful interference in a residential installation. This equipment generates, uses and can radiate radio frequency energy and, if not installed and used in accordance with the instructions, may cause harmful interference to radio communications. However, there is no guarantee that interference will not occur in a particular installation. If this equipment does cause harmful interference to radio or television reception, which can be determined by turning the equipment off and on, the user is encouraged to try to correct the interference by one or more of the following measures:

- Reorient or relocate the receiving antenna.
- Increase the separation between the equipment and receiver.
- Connect the equipment into an outlet on a circuit different from that to which the receiver is connected.
- Consult the dealer or an experienced radio/TV technician for help.

**CAUTION:** Changes or modifications to this device, not expressly approved by Icom Inc., could void your authority to operate this device under FCC regulations.



<b>A</b>		
Accessing repeaters .....	47	
Accessories .....	ii	
AM/FM radio mode selection .....	41	
Audio volume .....	12	
Auto Position Reply function .....	xi	
<b>B</b>		
Battery		
Cautions .....	vii	
Attaching/Detaching .....	10	
Charging with the power ON .....	iv	
BC radio		
Turning ON the BC Radio .....	41	
<b>C</b>		
Call		
Calling an individual station .....	59	
Call Types		
Gateway Repeater call .....	58	
Local area call .....	56	
Simplex call .....	47	
Call sign		
Call sign Capture .....	55	
Call sign Capture key .....	55	
Enter your call sign into the transceiver .....	14	
Register your call sign at a gateway repeater .....	16	
		<b>CD</b>
		Starting the CD .....
		Supplied CD .....
		<b>Charging</b>
		Caution .....
		Charging with the power ON .....
		Charging through the [DC IN] jack .....
		Charging time .....
		Country code list .....
		81
		<b>D</b>
		D-STAR Introduction .....
		Unique features of D-STAR .....
		Date
		Setting Date/Time .....
		DR function .....
		Dualwatch operation .....
		Turning Dualwatch ON or OFF .....
		Main band selection .....
		DTCS
		Function ON .....
		DTCS Code .....
		DTCS Polarity .....

---

## INDEX

<b>F</b>	
FCC information .....	82
Features .....	i
FM Repeater search function .....	xii
Formatting the microSD card.....	18
Front, top and side panels .....	1
Function display.....	6

<b>G</b>	
Gateway Repeater call .....	58
GPS Logger function .....	80
Log file .....	80
GPS operation .....	78
Displaying Position Data .....	78
GPS Position screen .....	79
GPS receive setting .....	78
When using the GPS receiver.....	iv

<b>H</b>	
History, RX.....	51

<b>I</b>	
Initial Setup.....	10

<b>L</b>	
Local area call .....	56
Local setting .....	12
Lock function .....	38
Log file .....	80

<b>M</b>	
Main band selection.....	33
Making a Call	
Gateway Repeater call.....	58
Local area call.....	56
Simplex call.....	47
Memory channel	
Programming .....	42
Selecting .....	43
MENU screen	
Menu items and their details .....	21
microSD	
About the microSD card.....	73
Formatting.....	18
Inserting .....	11
Removing.....	76
Monitor function .....	36

<b>O</b>	
Operating band.....	34
Operating mode.....	35

<b>P</b>	
Partial reset .....	81
Playing recorded audio.....	75
Power ON .....	12

<b>Q</b>		<b>T</b>	
QSO Recording function.....	xi	Time	
Recording a QSO audio.....	74	Setting Date/Time .....	12
Recording a QSO onto a microSD card.....	73	TSQL (Tone squelch)	
Stop recording.....	74	Function ON.....	5
Quick Menu .....	5	TSQL frequency.....	21
<b>R</b>		Transmit power levels .....	40
Receiving GPS data .....	13	Transmitting .....	39
Reflector operation .....	63	Troubleshooting .....	61
Register your call sign at a gateway repeater.....	16	Tuning step .....	34
Resetting .....	81	<b>U</b>	
Partial reset.....	81	Updating the repeater list .....	69
RX history		<b>V</b>	
Using the RX history .....	51	Voice TX function.....	xi
<b>S</b>			
Save setting.....	19		
Save setting data onto a microSD card .....	18		
Setting a frequency.....	35		
Setting Date/Time.....	12		
Simplex call .....	47		
Spurious signals .....	iv		
Squelch level .....	36		

## INDEX FOR MENU ITEMS

<b>A</b>	
Active Band .....	[Function>] 28
<<Access Point Mode>>.....	[DV Gateway>] 30
Alarm Area (Group).....	[GPS>GPS Alarm>] 23
Alarm Area (RX/Memory).....	[GPS>GPS Alarm>] 23
Alarm Select.....	[GPS>GPS Alarm>] 23
All Reset.....	[Others>Reset>] 31
Alphabet.....	[SPEECH>] 26
Altitude.....	[GPS>GPS TX Mode>D-PRS (DV-A)] 24
Altitude/Distance.....	[Display>Display Unit>] 29
Auto Mute.....	[BC Radio>BC Radio Set>] 23
Auto Power OFF.....	[Time Set>] 30
Auto Repeater.....	[Function>] 27
Auto Reply.....	[DV Set>] 25

<b>B</b>	
Backlight.....	[Display>] 28
Backlight Timer.....	[Display>] 28
Band Edge Beep.....	[Sounds>] 30
Bank Link.....	[Scan>] 21
Barometric.....	[Display>Display Unit>] 29
BC Radio.....	[Root] 23
BC Radio Level.....	[Sounds>] 29
BC Radio Memory.....	[BC Radio>] 23
<<BC Radio Mode>>.....	[BC Radio>] 23
<<BC Radio OFF>>.....	[BC Radio>] 23
<<BC Radio ON>>.....	[BC Radio>] 23
BC Radio Set.....	[BC Radio>] 23
Beep Level.....	[Sounds>] 30
Beep/Vol Level Link.....	[Sounds>] 30
BK.....	[DV Set>] 26
Busy LED.....	[Display>] 29
Busy Lockout.....	[Function>] 27

<b>C</b>	
Call Sign.....	[Root] 24
Charging (Power ON).....	[Function>] 28
CI-V.....	[Function>] 28
CI-V Address.....	[Function>CI-V>] 28
CI-V Baud Rate.....	[Function>CI-V>] 28
CI-V Transceiver.....	[Function>CI-V>] 28
CI-V (DATA Jack).....	[Function>CI-V>] 28
Clone.....	[Others>] 31
Clone Master Mode.....	[Others>Clone>] 31
Clone Mode.....	[Others>Clone>] 31
Comment.....	[GPS>GPS TX Mode>D-PRS (DV-A)] 24
CSV Format.....	[QSO/RX Log>] 27
CSV Format.....	[SD Card>Import/Export>] 31

<b>D</b>	
Date.....	[QSO/RX Log>CSV Format>] 27
Date.....	[SD Card>Import/Export/CSV Format>] 31
Data Extension.....	[GPS>GPS TX Mode>D-PRS (DV-A)] 24
Data Speed.....	[Function>] 28
Date/Time.....	[Time Set>] 30
DIAL SPEECH.....	[SPEECH>] 26
Dial Speed-UP.....	[Function>] 27
Digital Code.....	[DUP/TONE>] 21
Digital Monitor.....	[DV Set>] 26
Digital Repeater Set.....	[DV Set>] 26
Display.....	[Root] 28
Display Language.....	[Display>] 29
Display Unit.....	[Display>] 29
DTCS Code.....	[DUP/TONE>] 21
DTCS Polarity.....	[DUP/TONE>] 21
DTMF Memory.....	[DTMF/T-CALL>] 27
DTMF Speed.....	[DTMF/T-CALL>] 27
DTMF/T-CALL.....	[Root] 27

## INDEX FOR MENU ITEMS

DUP/TONE.....	[Root]	21
During RX/Standby.....	[Function>Remote MIC Key>]	27
During TX.....	[Function>Remote MIC Key>]	27
DV Auto Detect.....	[DV Set>]	26
DV Auto Reply.....	[Voice Memo>]	22
DV Data TX.....	[DV Set>]	25
DV Fast Data.....	[DV Set>]	25
DV Gateway.....	[Root]	30
DV Memory.....	[Root]	24
DV RX Backlight.....	[Display>]	29
DV Set.....	[Root]	25
D-PRS (DV-A).....	[GPS>GPS TX Mode>]	24
<b>E</b>		
Earphone Mode.....	[Sounds>]	30
Export.....	[SD Card>Import/Export>]	31
EMR.....	[DV Set>]	26
EMR AF Level.....	[DV Set>]	26
<b>F</b>		
Fast Data.....	[DV Set>DV Fast Data>]	25
File Split.....	[Voice Memo>QSO Recoder>Recoder Set>]	22
FM Antenna.....	[BC Radio>BC Radio Set>]	23
Format.....	[SD Card>]	31
Function.....	[Root]	27
<b>G</b>		
GPS.....	[Root]	23
GPS Alarm.....	[GPS>]	23
GPS Auto TX.....	[GPS>]	24
GPS Data Speed.....	[DV Set>DV Fast Data>]	25
GPS Indicator.....	[GPS>GPS Set>]	23
GPS Information.....	[GPS>]	23
GPS Logger.....	[GPS>]	23
GPS Logger.....	[GPS>GPS Logger>]	23
<<GPS Logger Only>>.....	[GPS>GPS Logger>]	24

GPS Memory.....	[GPS>]	23
GPS Message.....	[GPS>GPS TX Mode>NMEA (DV-G)]	24
GPS Out (To DATA jack).....	[GPS>GPS Set>]	23
GPS Position.....	[GPS>]	23
GPS Select.....	[GPS>GPS Set>]	23
GPS Sentence.....	[GPS>GPS TX Mode>NMEA (DV-G)]	24
GPS Set.....	[GPS>]	23
GPS Time Correct.....	[Time Set>]	30
GPS TX Mode.....	[GPS>]	24
<b>H</b>		
Headset Select.....	[Function>VOX>]	28
Heterodyne.....	[Function>]	28
Home CH Beep.....	[Sounds>]	30
<b>I</b>		
Import.....	[SD Card>Import/Export>]	31
Import/Export.....	[SD Card>]	31
Information.....	[Others>]	31
<b>K</b>		
Key Lock.....	[Function>]	27
Key-Touch Beep.....	[Sounds>]	30
<b>L</b>		
Latitude/Longitude.....	[Display>Display Unit>]	29
LCD Contrast.....	[Display>]	28
LCD Dimmer.....	[Display>]	28
Load Setting.....	[SD Card>]	30
<b>M</b>		
Manual Position.....	[GPS>GPS Set>]	23
MIC Gain (External).....	[Function>]	28
MIC Gain (Internal).....	[Function>]	28
MODE SPEECH.....	[SPEECH>]	26
Monitor.....	[Function>]	27
MY:.....	[Call Sign>]	24
My Call Sign.....	[My Station>]	25

## INDEX FOR MENU ITEMS

My Station.....[Root] 25

### N

<<New File>> ..... [SD Card>Save Setting>] 30

NMEA (DV-G) ..... [GPS>GPS TX Mode>] 24

### O

Offset Freq..... [DUP/TONE>] 21

Opening Message ..... [Display>] 29

Others..... [Root] 31

### P

Partial Reset..... [Others>Reset>] 31

Pause Timer ..... [Scan>] 21

Play Files ..... [Voice Memo>QSO Recorder>] 21

Play Files ..... [Voice Memo>Voice Recorder>] 22

Player Set ..... [Voice Memo>QSO Recorder>] 22

Player Set ..... [Voice Memo>Voice Recorder>] 22

Power Save..... [Function>] 27

Power Save (BC Radio)..... [BC Radio>BC Radio Set>] 23

Power Save (Internal GPS)..... [GPS>GPS Set>] 23

Program Link ..... [Scan>] 21

Program Skip..... [Scan>] 21

PTT Auto REC..... [Voice Memo>QSO Recorder>Recorder Set>] 22

PTT Lock..... [Function>] 27

### Q

QSO Log..... [QSO/RX Log>] 27

QSO Recorder..... [Voice Memo>] 21

QSO/RX Log..... [Root] 27

### R

R1: ..... [Call Sign>] 25

R2: ..... [Call Sign>] 25

Rainfall..... [Display>Display Unit>] 29

REC Mode..... [Voice Memo>QSO Recorder>Recorder Set>] 22

<<REC Start>> ..... [Voice Memo>QSO Recorder>] 21

Record..... [Voice Memo>Voice Recorder>] 22

Record ..... [Voice TX>] 22

Record Interval ..... [GPS>GPS Logger>] 23

Recorder Set ..... [Voice Memo>QSO Recorder>] 22

Recorder Set ..... [Voice Memo>Voice Recorder>] 22

Record Sentence..... [GPS>GPS Logger>] 24

Remote MIC Key ..... [Function>] 27

Repeat Time ..... [Voice TX>TX Set>] 22

<<Repeat TX>> ..... [Voice TX>] 22

Repeater List ..... [DV Memory>] 25

Repeater Tone ..... [DUP/TONE>] 21

Reply Position Display ..... [Display>] 29

Reset ..... [Others>] 31

Resume Timer ..... [Scan>] 21

RX Bass..... [DV Set>Tone Control>] 25

RX Bass Boost ..... [DV Set>Tone Control>] 25

RX Call Sign ..... [Display>] 29

RX Call Sign SPEECH ..... [SPEECH>] 26

RX Call Sign Write ..... [DV Set>] 26

RX History ..... [Root] 24

RX History Log ..... [QSO/RX Log>] 27

RX Message..... [Display>] 29

RX REC Condition. [Voice Memo>QSO Recorder>Recorder Set>] 22

RX Record (RPT) ..... [DV Set>] 26

RX Repeater Write ..... [DV Set>] 26

RX Treble ..... [DV Set>Tone Control>] 25

RX01: ..... [RX History>] 24

RX>CS SPEECH..... [SPEECH>] 26

[RX>CS] Key ..... [DV Set>] 26

### S

Save Setting ..... [SD Card>] 30

Scan ..... [Root] 21

Scan Stop Beep..... [Sounds>] 30

Scope AF Output ..... [Sounds>] 30

## INDEX FOR MENU ITEMS

Scroll Speed .....	[Display>]	29
SD Card .....	[Root]	30
SD Card Info .....	[SD Card>]	31
Separator/Decimal .....	[QSO/RX Log>CSV Format>]	27
Separator/Decimal .....	[SD Card>Import/Export/CSV Format>]	31
<<Single TX>> .....	[Voice TX>]	22
Skip Time .....	[Voice Memo>QSO Recoder>Player Set>]	22
Sound .....	[Root]	29
SPEECH .....	[Root]	26
SPEECH Language .....	[SPEECH>]	26
SPEECH Level .....	[SPEECH>]	26
SPEECH Speed .....	[SPEECH>]	26
Speed .....	[Display>Display Unit>]	29
SSID .....	[GPS>GPS TX Mode>D-PRS (DV-A)]	24
Standby Beep .....	[Sounds>]	30
Sub Band Mute .....	[Sounds>]	30
System Language .....	[Display>]	29
<b>T</b>		
Temperature .....	[Display>Display Unit>]	29
Temporary Skip Timer .....	[Scan>]	21
<<Terminal Mode>> .....	[DV Gateway>]	30
Time Set .....	[Root]	30
Time Stamp .....	[GPS>GPS TX Mode>D-PRS (DV-A)]	24
Time-Out Timer .....	[Function>]	27
Tone Burst .....	[DUP/TONE>]	21
Tone Control .....	[DV Set>]	25
TSQL Freq .....	[DUP/TONE>]	21
TX Bass .....	[DV Set>Tone Control>]	25
TX Call Sign .....	[Display>]	29
TX Delay (PTT) .....	[DV Set>DV Fast Data>]	25
TX Message .....	[My Station>]	25

TX Monitor .....	[Voice TX>TX Set>]	22
TX Set .....	[Voice TX>]	22
TX Treble .....	[DV Set>Tone Control>]	25

### U

Unmount .....	[SD Card>]	31
Unproto Address .....	[GPS>GPS TX Mode>D-PRS (DV-A)]	24
UR: .....	[Call Sign>]	24
UTC Offset .....	[Time Set>]	30

### V

Version .....	[Others>Information>]	31
Voice Memo .....	[Root]	21
Voice Recorder .....	[Voice Memo>QSO Recoder>Recorder Set>]	22
Voice TX .....	[Root]	22
Voltage .....	[Others>Information>]	31
Voltage (Power ON) .....	[Display>]	29
Volume Select .....	[Sounds>]	29
VOX .....	[Function>]	28
VOX .....	[Function>VOX>]	28
VOX Delay .....	[Function>VOX>]	28
VOX Level .....	[Function>VOX>]	28
VOX Time-Out Timer .....	[Function>VOX>]	28

### W

Wind Speed .....	[Display>Display Unit>]	29
------------------	-------------------------	----

### Y

Your Call Sign .....	[DV Memory>]	24
----------------------	--------------	----

## SPECIFICATIONS

### ■ General

- Frequency coverage: (unit: MHz)

	TX	RX
<b>EUR</b>	144 ~ 146, 430 ~ 440	144 ~ 146, 430 ~ 440
<b>USA</b>	144 ~ 148, 430 ~ 450*1	108 ~ 174*2, 380 ~ 479*1
<b>ALL</b>	—	BC band (AM): 0.520 ~ 1.710 BC band (FM): 76.0 ~ 108.0*3

\*1 Guaranteed 440 ~ 450 MHz only

\*2 Guaranteed 144 ~ 148 MHz only

\*3 88.0 ~ 108.0 MHz for the USA version.

**TIP:** The SUB band audio signal may be muted, depending on the combination of operating band and mode.

- Modes: FM (F2D/F3E), AM (A3E)\*, DV (F7W)  
\*Rx only
- Number of memory channels: 554 (including 50 scan edges and 4 call channels)
- Number of BC band memory channels: 500
- Usable temp. range:  $-20^{\circ}\text{C} \sim +60^{\circ}\text{C}$ ,  $-4^{\circ}\text{F} \sim +140^{\circ}\text{F}$
- Tuning steps: 1, 5, 6.25, 8.33, 9, 10, 12.5, 15, 20, 25, 30, 50, 100, 125, and 200 kHz  
\*The selectable steps may differ, depending on the selected frequency band or operating mode.
- Frequency stability:  $\pm 2.5$  ppm  
( $-20^{\circ}\text{C} \sim +60^{\circ}\text{C}$ ,  $-4^{\circ}\text{F} \sim +140^{\circ}\text{F}$ )
- Power supply: 10 ~ 16 V DC for external DC power, or specified Icom's battery pack
- Digital transmission speed: 4.8 kbps
- Voice coding speed: 2.4 kbps

- Current drain (with BP-271):
  - TX (at 5 W output) Less than 2.5 A
  - RX Max. output FM Less than 350 mA (Internal speaker)  
Less than 200 mA (External speaker)
  - DV Less than 450 mA (Internal speaker)  
Less than 300 mA (External speaker)
- Antenna impedance: 50  $\Omega$  (SMA)
- Dimensions: 58.0(W) $\times$ 105.4(H) $\times$ 26.4(D) mm,  
(projections not included)  
2.3(W) $\times$ 4.1(H) $\times$ 1.0(D) in
- Weight (approximately): 255 g, 9 oz  
(including battery pack and antenna)

### ■ Transmitter

- Modulation system:
  - FM Variable reactance frequency modulation
  - DV GMSK reactance frequency modulation
- Output power: High 5.0 W, Mid. 2.5 W,  
Low2 1.0 W, Low1 0.5 W,  
S-Low 0.1 W (Typical)
- Max. freq. deviation:  $\pm 5.0$  kHz (FM wide)  
 $\pm 2.5$  kHz (FM narrow)
- Occupied bandwidth: Less than 6.0 kHz (DV)
- Spurious emissions: Less than  $-60$  dBc at High/Mid.  
Less than  $-13$  dBm at Low2/  
Low1/S-Low
- Ext. mic. impedance: 2.2 k $\Omega$



## ■ Receiver

- Receive system: Double-conversion superheterodyne
- Intermediate frequencies:
  - A Band 46.35 MHz (1st IF)  
450 kHz (2nd IF)
  - B Band 61.65 MHz (1st IF)  
450 kHz (2nd IF)
- Sensitivity (except spurious points):

AM (1 kHz 30% MOD; 10 dB S/N)

0.520 to 0.995 MHz	Less than 3.2 $\mu$ V
1.000 to 1.710 MHz	Less than 1.8 $\mu$ V
108.000 to 136.995 MHz	Less than 1.8 $\mu$ V

FM (1 kHz $\pm$ 3.5 kHz Dev.; 12 dB SINAD)

137.0 to 174.0 MHz	
Amateur band only	Less than 0.18 $\mu$ V
Except for Amateur band	Less than 0.32 $\mu$ V
380.0 to 479.0 MHz	
Amateur band only	Less than 0.18 $\mu$ V
Except for Amateur band	Less than 0.32 $\mu$ V

WFM (1 kHz $\pm$ 52.5 kHz Dev.; 12 dB SINAD)

76.0 to 81.9 MHz	Less than 3.2 $\mu$ V
82.0 to 108.0 MHz	Less than 1.8 $\mu$ V

DV (PN9/GMSK 4.8 kbps; BER 1%)

137.0 to 174.0 MHz	
Amateur band only	Less than 0.28 $\mu$ V
380.0 to 479.0 MHz	
Amateur band only	Less than 0.28 $\mu$ V

- Audio output power (at 10% distortion):
  - Internal speaker More than 0.4 W into a 16  $\Omega$  load
  - External speaker More than 0.2 W into an 8  $\Omega$  load
- Selectivity:
  - FM (Wide) More than 55 dB
  - FM (Narrow), DV More than 50 dB
- Ext. speaker impedance: 8  $\Omega$   
(3-conductor 3.5 mm, 1/8" (d))
- Spurious and image rejection ratio: More than 60 dB

- Squelch Sensitivity (except spurious points):

AM (1 kHz 30% MOD, 10 dB S/N) (threshold)

0.520 to 0.995 MHz	Less than 3.2 $\mu$ V
1.000 to 1.710 MHz	Less than 1.8 $\mu$ V
108.000 to 136.995 MHz	Less than 1.8 $\mu$ V

FM (1 kHz $\pm$ 3.5 kHz Dev., 12 dB SINAD) (threshold)

137.0 to 174.0 MHz	
Amateur band only	Less than 0.18 $\mu$ V
Except for Amateur band	Less than 0.32 $\mu$ V
380.0 to 479.0 MHz	
Amateur band only	Less than 0.18 $\mu$ V
Except for Amateur band	Less than 0.32 $\mu$ V

WFM (1 kHz $\pm$ 52.5 kHz Dev., 12 dB SINAD) (threshold)

76.0 to 81.9 MHz	Less than 3.2 $\mu$ V
82.0 to 108.0 MHz	Less than 1.8 $\mu$ V





# Count on us!

#76 Europe-12

#77 Europe-13

#78 Europe-14

#79 Europe-15

#80 Europe-16

<Intended Country of Use>											
<input type="checkbox"/> AT	<input type="checkbox"/> BE	<input type="checkbox"/> CY	<input type="checkbox"/> CZ	<input type="checkbox"/> DK	<input type="checkbox"/> EE						
<input type="checkbox"/> FI	<input type="checkbox"/> FR	<input type="checkbox"/> DE	<input type="checkbox"/> GR	<input type="checkbox"/> HU	<input type="checkbox"/> IE						
<input type="checkbox"/> IT	<input type="checkbox"/> LV	<input type="checkbox"/> LT	<input type="checkbox"/> LU	<input type="checkbox"/> MT	<input type="checkbox"/> NL						
<input type="checkbox"/> PL	<input type="checkbox"/> PT	<input type="checkbox"/> SK	<input type="checkbox"/> SI	<input type="checkbox"/> ES	<input type="checkbox"/> SE						
<input type="checkbox"/> GB	<input type="checkbox"/> IS	<input type="checkbox"/> LI	<input type="checkbox"/> NO	<input type="checkbox"/> CH	<input type="checkbox"/> BG						
<input type="checkbox"/> RO	<input type="checkbox"/> TR	<input type="checkbox"/> HR									