

YAESU
The radio

FTM-400XDR/DE

Operating Manual

144/430MHz 50W
DUAL BAND TRANSCEIVER

C4FM/FM



- Before Using
- Installation and Connection
- Basic Operations
- DG-ID / DP-ID Function
- Using the Memory
- Scanning
- Using the GPS Function
- Using the APRS Function
- Using the GM Function
- Using the WIRES-X Function
- Convenient Functions
- Functions to be used when Necessary
- Customize Menu Settings and User Preferences
- Appendix

Features of this radio

- 144/430 MHz dual band mobile radio equipped with standard C4FM digital communication modem
 - Clear audio and data communication is achieved using the digital modem functions
 - Wide band receive in the 108 MHz to 999 MHz range (wireless business, public service and air band)
 - Transmit power 50 watts with cooling fan
 - Full color 3.5-inch LCD, high luminance TFT touch panel controller
 - Intuitive, user touch panel operation
 - With the DG-ID (Digital Group ID) feature, the Group Monitor (GM) feature enables automatically locating, and communicating with other stations that have the same DG-ID number within contact range, by utilizing a matching group ID number from 00 to 99.
 - The Digital Personal ID (DP-ID) feature may communicate only by the transceivers registered the individual ID information that is different for each transceiver included in the transmission radio wave of C4FM digital communication.
 - 500 memory channels in the Band A (band at the top of the display) and 500 channels in the Band B (band at the bottom of the display)
 - The frequency and settings memories can be saved, using a micro-SD card. The data in the micro-SD card can easily be copied to other radios
 - Diverse range of scanning functions (VFO scan, memory scan etc.)
 - Built-in GPS receiver unit, location and movement information can be displayed and GPS data can be output to connected devices
 - Incorporated APRS® functions. Position, movement data and messages can be communicated to other stations, digipeaters and the Internet.
*Refer to the separate “APRS Operating Manual”
 - Equipped with GM (Group Monitor) function
*Refer to the separate “GM Operating Manual”
 - Supports Yaesu WIRES-X Internet linking, providing communication with remote partners using the Internet
*Refer to the separate “WIRES-X Operating Manual”
 - Bluetooth adaptor unit BU-2 (sold separately) permits hands-free operation
 - Voice guide unit FVS-2 (sold separately) provides frequency voice announcement, and recording of received audio
 - Camera-equipped microphone MH-85A11U (sold separately). Images taken with the camera can be transmitted to other stations, and also shown on the LCD display.
- * The APRS, GM and WIRES-X Operating Manuals are not included with the product. Please download them from the Yaesu website.

Important precautions for mobile radio operation

- The use of protective tape or covering is recommended to protect the wiring and the power cord inside the vehicle.
- When installing the unit inside a vehicle, locate the radio, antenna, co-axial cable, etc. at least 20 cm away from the following control equipment.
 - **Engine-related:** Fuel injection equipment and engine control
 - **Transmission-related:** Transmission and 4WD electronic control unit
 - **Others:** ECS/EPS/ABS/ETACS/Fully automatic air-conditioner/
Auto-heater control unit/G sensor
- Install the antenna and co-axial cable away from the control unit and wiring harness. Place all cables so they do not entangle and impede the driver or passengers. Never place any equipment in a location where it may pose a danger to the passengers, where it may interfere with driving, or obstruct the driver field of view.
- Do not install any apparatus in such a way that it may interfere with the proper operation of the air bags.
- After installing the radio, check that the brake lamp, head lamp, turning indicator lights, wiper, etc. are working normally with the radio power switched on.
- Keep full attention on driving, do not operate the radio controls or look at the radio display while driving. Stop the vehicle at a safe location, before operating the radio controls or looking at the display.
- Do not drive the car in such a way that external sounds required for safe driving cannot be heard. Most areas and districts prohibit the use of earphones and headphones while driving.
- When using the radio transmitter, if it appears to have abnormal effects on the control equipment of the vehicle, stop the engine, turn off the power supply, and disconnect the power cord. Resolve the problem before continuing to operate the radio equipment.
- When using the radio in an electric or hybrid car, the receiver may experience high RF interference and noise from the inverters that are built into the electric vehicle.

About the touch panel

● Precautions in using the touch panel

The touch panel of the controller is designed to work with the slightest touch of a finger.

- The touch panel may not work when a protective film or sheet is adhered to the LCD.
- Use of a pointed fingernail or pen to operate the touch panel, or pressing too hard may damage or scratch the screen.
- Smart phone operations such as flicking, pinch in and pinch out are not possible.

● Maintaining the touch panel

- To clean the touch panel, switch off the power supply first before using a dry, soft cloth to wipe away dust and dirt from the touch panel.

When the touch panel is really dirty, wet a soft cloth and wring it out thoroughly before using it to wipe the touch panel.

- When wiping the touch panel, be careful not to wipe too hard or scratch the surface with your nails.

When the touch panel is scratched, it may become difficult to see the display.

About registered trademarks and copyrights

APRS is a registered trademark of Mr. Bob Bruninga of WB4APR.

SmartBeaconing is supplied by HamHUD Nichetronix.

Microsoft, Windows and Windows Vista are registered trademarks of Microsoft Corporation in the United States and other countries.

Other company and product names listed in this manual are trademarks and registered trademarks of their respective companies.

Unauthorized reproduction or copying of a part or all of the copyrights owned by Yaesu Musen Co., Ltd. in any form whatsoever is strictly prohibited.

How to read this manual

In this manual, controller operations are expressed as follows:

Press  Indicates that the key or switch is to be pressed quickly.

Press  for 1 second or longer Indicates that the key or switch is to be pressed for one second or longer.

Touch **[SQL]** Indicates that the symbol on the touch panel screen is to be touched quickly.

Touch **[SQL]** for 1 second or longer ... Indicates that the symbol on the touch panel screen is to be touched for one second or longer.

Select **[MODE]** Indicates that the items are to be highlighted on the touch panel screen.

The following symbols are also used in this manual:

Caution

 ...Explains information to avoid incorrect operation.

Tip

 ...Explains operating hints and helpful advice.

Also note: the actual product may differ from the drawings shown in this manual.

Contents

Introduction.....	2	Communicating.....	49
Features of this radio.....	2	Transmitting.....	49
Important precautions for mobile radio operation.....	3	Adjusting the transmit power.....	50
About the touch panel.....	4	Adjusting the sensitivity of the microphone.....	50
About registered trademarks and copyrights.....	4	Communicating in the FM mode.....	51
How to read this manual.....	5	Communicating using the repeater.....	52
Before Using.....	9	Other Settings.....	54
Safety Precautions (make sure to read these).....	9	Changing the beep volume.....	54
Accessories.....	13	Locking the knobs and switches.....	55
Name and Function of Each Component.....	14	Adjusting the date and time.....	56
Controller.....	14	Adjusting the display brightness.....	58
Front.....	14	Changing the background color of the	
Back.....	15	frequency display area.....	60
Left side.....	15	Reconfiguring the Settings.....	61
Main body.....	16	DG-ID / DP-ID Function.....	62
Front.....	16	Digital Group ID (DG-ID) feature.....	62
Back.....	16	Communicating only with the specific members	
Microphone (MH-48A6JA).....	17	by setting the DG-ID number except for "00".....	62
Explanation of the screen.....	18	Digital Personal ID (DP-ID) feature.....	64
Installation and Connection.....	24	Registering the DP-ID to a DR-2X/XE digital	
Installing the Radio.....	24	repeater.....	64
Precautions during installation.....	24	Registering the transceiver.....	64
Installation location when used in a mobile unit.....	24	Deleting the registered DP-ID.....	65
About the antenna.....	25	Using the Memory.....	66
Install the antenna.....	25	Writing to the memory.....	66
Installing the main body.....	27	Recalling the memory.....	67
Installing the controller.....	28	Recalling the home channel.....	67
Connecting the Radio.....	29	Changing the frequency of the home channel.....	68
Connecting the controller to the main body.....	29	Erasing the memory.....	69
Connecting the microphone.....	29	Naming the memory.....	70
Connecting the antenna.....	29	Changing the method of the memory tag display... ..	71
Connecting the Power Supply.....	30	Split memory.....	72
Connecting the car battery.....	30	Receiving Weather Broadcast Channels	
Connecting the external power supply equipment.....	32	(USA version only).....	74
Setting Up the micro-SD Card.....	33	Assigning the "WX" function to a programmable	
Micro-SD cards that can be used.....	33	key on the microphone.....	75
Things to note when using micro-SD cards.....	33	Recalling the weather channels.....	75
Installing the micro-SD card.....	34	Listening the weather alert.....	75
Removing the micro-SD card.....	34	Scanning.....	76
Initializing the micro-SD card.....	35	Signal Search.....	76
Basic Operations.....	36	VFO scan.....	76
Receiving.....	36	Setting the receive operation when the	
Turning the power on.....	36	scanning stops.....	77
Switching the power off.....	36	Memory scan.....	78
Inputting the call sign.....	37	Selecting the scanning method.....	79
Switching the operating band.....	38	Setting the specified memories.....	79
Adjusting the volume.....	38	Scan only the specified memory channels.....	80
Adjusting the squelch level.....	39	Setting the memories to be skipped.....	81
Tuning the radio.....	40	Scanning the programmable memories (PMS).....	83
Changing the frequency steps.....	41	Writing into the programmable memory.....	83
Switching the operating mode.....	44	Scanning the programmable memory.....	84
Switching the communication mode.....	45	Monitoring the Home Channel.....	85
Switching the modulation mode.....	46	Using the dual receive.....	85
Displaying the band scope.....	47	Setting the restart condition of dual receive.....	86
Muting the audio.....	48		

Using the GPS Function	87	Using the TOT function.....	124
What is GPS?	87	Changing the Touch Key Function.....	125
Positioning Using GPS	87	Sending and Receiving Messages and Pictures	126
Positioning using an external GPS device.....	88	Viewing messages and pictures	126
Checking the satellite capture status.....	90	Sorting the messages and pictures	127
Displaying the position information.....	91	Downloading messages and images.....	128
Displaying the current position information		Sending messages and pictures	129
of your station	91	Creating and sending a message.....	129
Displaying the position information of the		Sending saved pictures	133
partner station in the digital mode	91	Replying to a message or picture	134
Explanation of the position information screen.....	92	Forwarding messages and pictures.....	136
Recording the position information		Functions to be Used when Necessary.....	138
(GPS log function)	93	Using the Bluetooth Headset.....	138
Checking the route using a personal computer...	94	Mounting the Bluetooth unit "BU-2"	138
Measuring the altitude	94	Setting the Bluetooth headset operation	140
Other settings	96	Identifying the Bluetooth headset	141
Using the Smart Navigation Function	97	Using the Bluetooth headset	143
Displaying the Compass screen	97	Taking Pictures with the optional Camera	
Using the real-time navigation function	98	(Snapshot Function)	144
Using the backtrack function	99	Connecting the speaker microphone	
Saving the destination	99	with camera	144
Displaying the position of the		Taking pictures.....	145
destination in real time.....	101	Viewing a saved picture.....	147
Using the APRS Function	102	Optional receive Audio Record and Playback	148
What is the APRS Function?	102	Mounting the voice guide unit "FVS-2"	148
Using the GM / WIRES-X Function.....	103	Using the voice memory	150
What is the GM Function?	103	Setting the voice memory operation	150
Basic Methods to use the GM/WIRES-X function ...	104	Recording the receive audio.....	151
What is the WIRES-X Function?	105	Replaying the recorded audio.....	151
Convenient Functions.....	106	Erasing the recorded audio.....	152
Communicating with Specified Partner Stations.....	106	Listening to the frequency voice announcement...	153
Using the tone squelch	106	Setting the announce function operation	153
Setting the tone frequency.....	106	Listening to the frequency voice announcement...	154
Using the tone squelch	107	Copying the Radio Data to another Transceiver....	155
Transmitting the tone signal.....	107	Using the micro-SD card	155
Using digital code squelch.....	108	Copying data to a micro-SD card.....	155
Setting the DCS code	108	Copying data from the micro-SD card	156
Using DCS	109	Using the clone function	157
Using the pager function.....	110	Using the Radio with an External Device Connected...	159
Setting the receive station code	110	Connecting to a personal computer.....	159
Activating the pager function	112	Sending position information to the computer ...	160
Recalling a specified station.....	112	Updating the firmware of the radio	161
Notification of an incoming call from a		Using the radio as a transceiver for packet	
partner station using the bell	114	communication	162
Other squelch functions.....	114	Other devices that can be connected.....	166
Using the DTMF Function.....	116	Customize Menu Settings and User Preferences... 	167
Registering the DTMF code.....	116	Set-up Menu Basic Operations.....	167
Transmitting the registered DTMF code	117	Set-up Menu List	168
Sending out the DTMF code manually	118	Using the Set-up Menu.....	175
Using the Timer Function.....	119	Screen display settings.....	175
Using the stopwatch function.....	119	Select the screen to be displayed.....	175
Displaying the timer / clock screen	119	Switching between COMPASS and	
Using the lap timer.....	120	POSITION INFORMATION screens	176
Using the countdown timer	121	Setting the display background color.....	176
Using the APO function	123	Setting the band scope display width	176
		Setting the display brightness.....	177

Contents

Setting the display contrast.....	177
Switching the time display and the voltage display ...	177
Transmit and receive settings.....	178
Setting the signal format.....	178
Setting the AMS transmission mode.....	178
Setting the pop-up time for the partner station information.....	180
Setting the display method for my position.....	180
Setting the Standby Beep.....	180
Displaying the version of the DSP program.....	181
Setting the sub-band mute.....	181
Setting the sensitivity of the microphone.....	182
Memory channel settings.....	182
Setting the display method for the memory tag... ..	182
Setting the memory scan method.....	182
Tone signal settings.....	182
Setting the squelch tone frequency (CTCSS)... ..	182
Setting the DCS code.....	182
Setting the transmission method of the DTMF code.....	182
Registering the DTMF code.....	182
Recalling only specified stations.....	183
Setting the user programmed reverse CTCSS tone.....	183
Using the bell Notification of an incoming call from a partner station using the bell.....	184
Setting the squelch type separately for transmit and receive.....	184
Setting the weather alert operation (USA Version Only).....	184
Scan settings.....	185
Setting the signal reception method.....	185
Setting the scanning direction.....	185
Setting the receive operation when the scanning stops.....	186
Group monitor function settings.....	186
Settings on the functions and configuration.....	186
Setting the date and time.....	186
Setting the display format for the date and time... ..	187
Setting the time zone.....	188
Setting the auto repeater shift.....	189
Setting the direction of the repeater shift.....	189
Setting the shift width of the repeater.....	190
Setting the frequency step.....	191
Setting the volume of the beep.....	191
Setting the clock shift of the CPU.....	191
Setting the program key of the microphone.....	192
Expanding the receive range.....	193
Setting the unit display.....	194
Switching the power off automatically.....	194
Limiting the continuous transmission time.....	194
Setting the PIN code of the optional Bluetooth headset.....	194
Setting the geodetic reference system of the GPS function.....	195
Positioning using the external GPS device.....	195
Setting the interval for recording the GPS position information.....	195
Data communication settings.....	196
Setting the COM port.....	196
Setting the operating band of the APRS and data communication.....	199
Setting the baud rate of the APRS and data communication.....	200
Setting the output condition of the squelch detection and squelch terminal.....	201
APRS function settings.....	202
Micro-SD card settings.....	203
Writing settings to the micro-SD card.....	203
Writing group IDs to the micro-SD card.....	203
Initializing the micro-SD card.....	203
Optional device settings.....	203
Setting the image of the connected speaker microphone with camera.....	203
Setting the operation of the Bluetooth headset... ..	204
Setting the voice memory operation.....	204
Initialization and saving settings.....	204
Reconfiguring the settings.....	204
Registering the preset.....	204
Recalling the registered preset.....	205
Sorting the registered memory channels.....	206
Copying saved data.....	206
Call sign settings.....	207
Changing the call sign.....	207
Appendix.....	208
Options List.....	208
Maintenance.....	209
Care and maintenance.....	209
Replacing the fuse.....	209
When you have difficulties.....	210
There is no power.....	210
There is no sound.....	210
There is no transmission.....	210
The keys or knobs will not operate.....	210
About internal spurious signals.....	211
After-market Services.....	211
Specification.....	212
Index.....	214

Safety Precautions (make sure to read these)

Make sure to read this manual in order to use this radio safely and correctly.

Note beforehand that the company shall not be liable for any damages suffered by the customer or third parties in using this product, or for any failures and faults that occur during the use or misuse of this product, unless otherwise provided for under the law.

Type and meaning of the marks



This symbol indicates the possibility of death or serious injury being inflicted on the user and the surrounding people when these instructions are ignored and the product is handled wrongly.



This symbol indicates the possibility of death or serious injury being inflicted on the user and the surrounding people when these instructions are ignored and the product is handled wrongly.



This symbol indicates the possibility of physical impediments occurring or impediments being inflicted on the user and the surrounding people when these instructions are ignored and the product is handled wrongly.

Type and meaning of symbols



Prohibited actions that must not be carried out in order to use this radio safely.

For example,  signifies that disassembly is prohibited.



Precautions that must be adhered to in order to use this radio safely. For example,  signifies that the power supply is to be disconnected.

||||| **DANGER** |||||



Do not use the device in “regions or aircrafts and vehicles where its use is prohibited” such as in hospitals and aeroplanes.

This may exert an impact on electronic and medical devices.



Do not use this product while driving or riding a motorbike. This may result in accidents.

Make sure to stop the car in a safe location first before use if the device is going to be used by the driver.



Never touch the antenna during transmission.

This may result in injury, electric shock and equipment failure.



When an alarm goes off with the external antenna connected, cut off the power supply to this radio immediately and disconnect the external antenna from this radio.

If not, this may result in fire, electric shock and equipment failure.

Safety Precautions (make sure to read these)



Do not operate the device when flammable gas is generated.

Doing so may result in fire and explosion.



Do not transmit in crowded places in consideration of people who are fitted with medical devices such as heart pacemakers.

Electromagnetic waves from the device may affect the medical device, resulting in accidents caused by malfunctions.



Do not touch any liquid leaking from the liquid display with your bare hands.

There is a risk of chemical burns occurring when the liquid comes into contact with the skin or gets into the eyes. In this case, seek medical treatment immediately.



WARNING



Do not use voltages other than the specified power supply voltage.

Doing so may result in fire and electric shock.



Do not transmit continuously for long periods of time.

This may cause the temperature of the main body to rise and result in burns and failures due to overheating.



Do not dismantle or modify the device.

This may result in injury, electric shock and equipment failure.



Do not handle the power plug and connector etc. with wet hands. Also do not plug and unplug the power plug with wet hands.

This may result in injury, liquid leak, electric shock and equipment failure.



When smoke or strange odors are emitted from the radio, turn off the power and disconnect the power cord from the socket.

This may result in fire, liquid leak, overheating, damage, ignition and equipment failure. Please contact our company amateur customer support or the retail store where you purchased the device.



Keep the power plug pins and the surrounding areas clean at all times.

This may result in fire, liquid leak, overheating, breakage, ignition etc.



Do not place the device in areas that may get wet easily (e.g. near a humidifier).

This may result in fire, electric shock and equipment failure.



When connecting a DC power cord, pay due care not to mix up the positive and negative polarities.

This may result in fire, electric shock and equipment failure.



Do not use DC power cords other than the one enclosed or specified.

This may result in fire, electric shock and equipment failure.



Do not bend, twist, pull, heat and modify the power cord and connection cables in an unreasonable manner.

This may cut or damage the cables and result in fire, electric shock and equipment failure.



Do not pull the cable when plugging and unplugging the power cord and connection cables.

Please hold the plug or connector when unplugging. If not, this may result in fire, electric shock and equipment failure.



When transmitting, keep the antenna at least 1.8 m (VHF) or 2.2 m (UHF) away from your body.

Do not use modified or damaged antennas.

Safety Precautions (make sure to read these)

 **Do not use the device when the power cord and connection cables are damaged, and when the DC power connector cannot be plugged in tightly.**

Please contact our company amateur customer support or the retail store where you purchased the device as this may result in fire, electric shock and equipment failure.

 **Never cut off the fuse holder of the DC power cord.**

This may cause short-circuiting and result in ignition and fire.

 **Do not use fuses other than those specified.**

Doing so may result in fire and equipment failure.

 **Do not allow metallic objects such as wires and water to get inside the product.**

This may result in fire, electric shock and equipment failure.

 **Refrain from using headphones and earphones at a loud volume.**
Continuous exposure to loud volumes may result in hearing impairment.

 **Disconnect the power cord and connection cables before incorporating items sold separately and replacing the fuse.**

This may result in fire, electric shock and equipment failure.

 **Follow the instructions given when installing items sold separately and replacing the fuse.**

This may result in fire, electric shock and equipment failure.

 **Do not use the device when the alarm goes off.**

For safety reasons, please pull the power plug of the DC power equipment connected to the product out of the AC socket.

Never touch the antenna as well. This may result in fire, electric shock and equipment failure due to thunder.

Before Using



CAUTION

 **Do not place this device near a heating instrument or in a location exposed to direct sunlight.**

This may result in deformation and discoloration.

 **Do not place this device in a location where there is a lot of dust and humidity.**

Doing so may result in fire and equipment failure.

 **Stay as far away from the antenna as possible during transmission.**

Long-term exposure to electromagnetic radiation may have a negative effect on the human body.

 **Do not wipe the case using thinner and benzene etc.**

Please use a soft and dry piece of cloth to wipe away the stains on the case.

 **For safety reasons, switch off the power and pull out the DC power cord connected to the DC power connector when the device is not going to be used for a long period of time.**

If not, this may result in fire and overheating.

 **Do not throw or subject the device to strong impact forces.**

This may result in equipment failure.

 **Do not put this device near magnetic cards and video tapes.**

The data in the cash card and video tape etc. may be erased.

 **Do not turn on the volume too high when using a headphone or earphone.**

This may result in hearing impairment.

Safety Precautions (make sure to read these)



Keep out of the reach of small children.

If not, this may result in injuries to children.



Do not put heavy objects on top of the power cord and connection cables.

This may damage the power cord and connection cables, resulting in fire and electric shock.



Do not transmit near the television and radio.

This may result in electromagnetic interference.



Do not use optional products other than those specified by our company.

If not, this may result in equipment failure.



When using the device in a hybrid car or fuel-saving car, make sure to check with the car manufacturer before using.

The device may not be able to receive transmissions normally due to the influence of noises from the electrical devices (inverters etc.) fitted in the car.



Do not place the device on an unsteady or sloping surface, or in a location where there is a lot of vibration.

The device may fall over or drop, resulting in fire, injury and equipment failure.



Do not stand on top of the product, and do not place heavy objects on top or insert objects inside it.

If not, this may result in equipment failure.



Do not use a microphone other than those specified when connecting a microphone to the device.

If not, this may result in equipment failure.



Do not touch the heat radiating parts.

When used for a long period of time, the temperature of the heat radiating parts will get higher, resulting in burns when touched.



Do not open the case of the product except when replacing the fuse and when installing items sold separately.

This may result in injury, electric shock and equipment failure.

Accessories

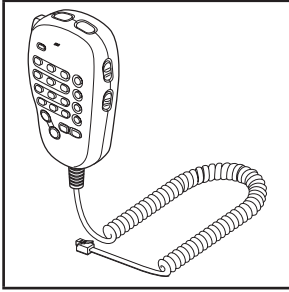

DTMF microphone
MH-48A6JA

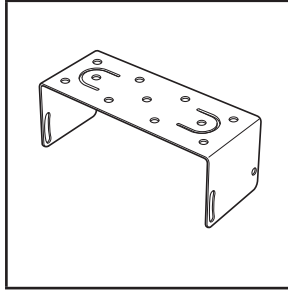

Bracket for main body
MMB-36

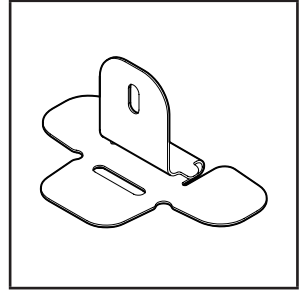

Bracket for the
controller

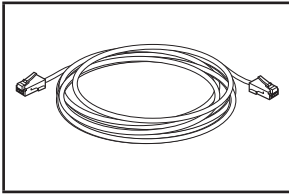

Controller cable
(3 m)

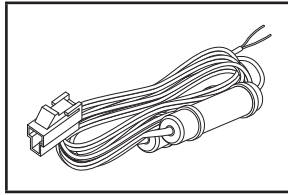

DC power cable
(with fuse attached)
(USA, EXP version)

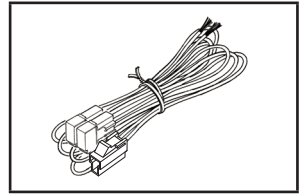

DC power cable
(with fuse attached)
(European version)

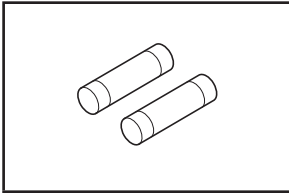

Spare fuse (15 A)
(USA, EXP version)

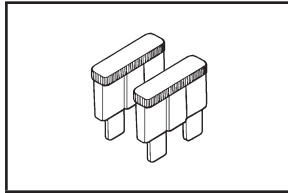

Spare Fuse (15 A)
(European version)

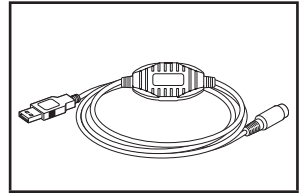

PC connection cable
SCU-20

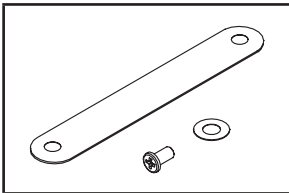

Microphone cord holder

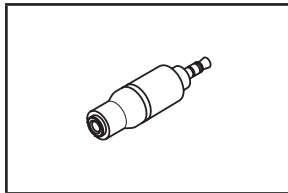

Stereo to Monaural Plug

Operating Manual
Warranty Card
Quick Manual

Tip



Various optional parts are also available.
Refer to Page 206 for details.

Name and Function of Each Component

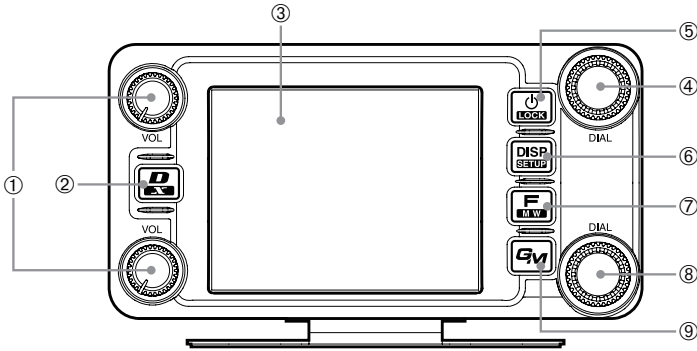

Controller

Front





- ① VOL knob ( )

The volume will increase when the knob is turned in a clockwise direction and decrease when turned in an counter-clockwise direction.
The upper end is for Band A use while the lower end is for Band B use.
- ② D/X key ()

The communication mode changes each time this key is pressed for a short time.
Tip Refer to Page 45 for the communication mode.
WIRES-X will start when this key is pressed for one second or longer.
- ③ Touch panel display
- ④ Band A DIAL knob ()
 - The frequency of the upper band in the dual band display can be adjusted.
The frequency will increase when the knob is turned in a clockwise direction and decrease when turned in an counter-clockwise direction.
Press the knob to enable setting the operating band frequency in 1 MHz units.
Press the knob for one second or longer to enable setting the frequency in 5 MHz units.
 - In memory mode when the knob is pressed for one second or longer, if a tag (name) is attached to the memory channel, the tag and frequency displays will be reversed.
 - This knob is also used to select the items during the set up and memory operations, group monitor operations, etc.
- ⑤ Power supply/LOCK switch ()

Press this button for 2 seconds or longer to switch the power on and off.
The key lock can be engaged or released by pressing the button quickly while the radio is turned on.
- ⑥ DISP/SETUP key ()

The display screen will change each time the button is pressed quickly.
Tip Refer to Page 20 for the display.
Press the button for one second or longer to display the set-up menu.

- ⑦ F/MW key ()
 Press the button quickly to display the function menu.
 Press the button for 2 seconds or longer to change to the memory writing mode.
- ⑧ Band B DIAL knob ()
 - The frequency of the upper band in the dual band display can be adjusted.
 Press the knob to enable setting the operating band frequency in 1 MHz units.
 Press the knob for one second or longer to enable setting the frequency in 5 MHz units.
 - In memory mode when the knob is pressed for one second or longer, if a tag (name) is attached to the memory channel, the tag and frequency displays will be reversed.
- ⑨ GM key ()
 Press this key to start the group monitor function.
 Press this key for one second or longer to DG-ID number setting screen is displayed.

Back

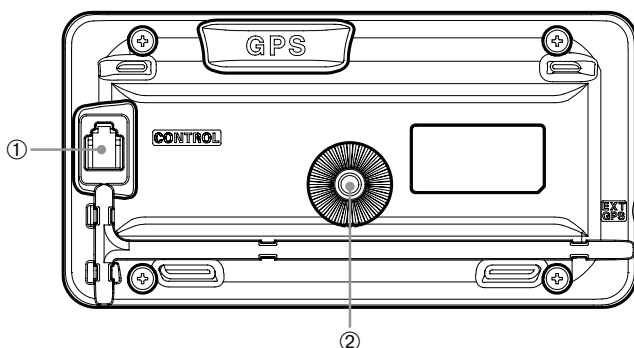

- ① CONTROL jack
 Plug in the control cable into this jack to connect with the main body.
- ② Screw hole to attach the mounting bracket

Left side

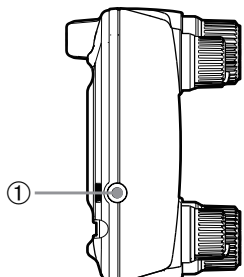
- ① EXT GPS jack
 Plug in a cable to connect with external GPS devices.
- 
- The diagram shows the left side of the device. It is oriented vertically. On the left side, there is a circular jack. A line with the number '1' points to this jack. At the bottom of the device, there are two rectangular ports, likely for power or data.

Main body

Front

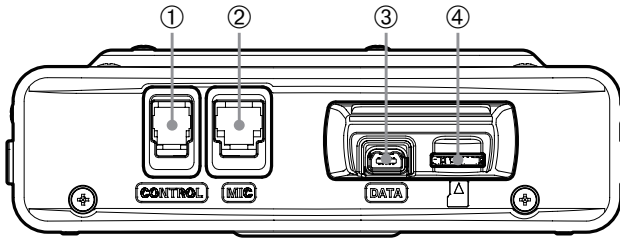

- ① CONTROL jack
Plug in the control cable into this jack to connect with the controller.
- ② MIC jack
Plug in the provided microphone cable.
- ③ DATA jack
Connect MH-85A11U, the optional speaker microphone with camera.
* There is no audio output available from the FTM-400XDR/DE to the MH-85A11U speaker.
- ④ micro-SD card slot

Back

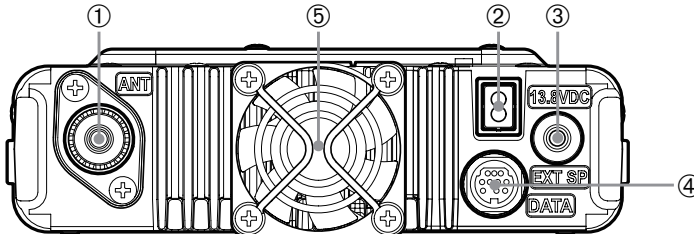

- ① ANT terminal
Connect the co-axial cable for the antenna.
- ② 13.8 VDC
Connect the provided DC power supply cable (with fuse attached).
- ③ EXT SP jack
Connect the optional external speaker.
- ④ DATA jack
Connect a cable for remote operation or the cable for connecting with the personal computer interface unit and the external terminal unit (refer P.159).
- ⑤ Cooling fan

Microphone (MH-48A6JA)

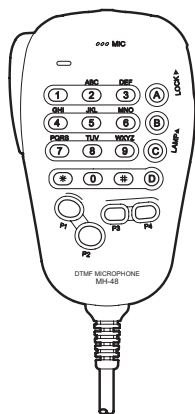
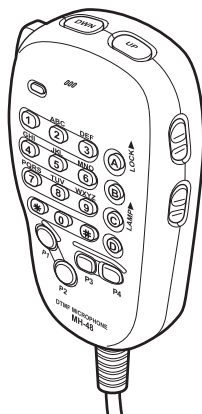

- [UP]** Frequency is increased by 1 step.
- [DWN]** Frequency is decreased by 1 step.
- [LOCK]** Locks / unlocks the [UP] and [DWN] keys and [P1] to [P4] keys.
- [LAMP]** Turns the lamp on the body of the microphone on/off.
- [MIC]** Speak into here during transmission.
- [1] to [0]** Enters the numbers and letters.
- [*]** Changes the VFO/Memory operating mode of the operating band.
- [#]** Activates the GM (Group Monitor) functions.
- [A]** Switches the operating band to Band A.
- [B]** Switches the operating band to Band B.
- [C]** Adjusts the squelch level.
- [D]** Switches the display.
- [P1]** Turns off the squelch (T.CALL: European version).
- [P2]** Recalls the receiver home channel.
- [P3]** Changes the communication mode.
- [P4]** Changes the transmit power.
- [PTT]** Press this key to begin the transmit mode.

Tip

Preferred functions can be assigned to buttons [P1] to [P4]. Select using the **[CONFIG]→[10 MIC PROGRAM KEY]** in the set-up menu.

Explanation of the screen

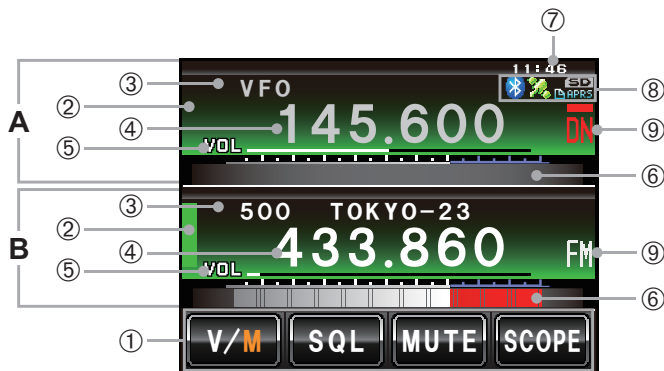

A Band A display area

B Band B display area

The characters of the name tag and frequency are displayed in white for the operating band, and gray for the sub-band.

① Touch key display area

Functions to be displayed in the function menu screen can be assigned to the touch keys. Refer to “Changing the touch key functions” (P.125) for details.

② Status display area

A green bar is displayed during receive and when signals are detected.

The bar will not be displayed when the squelch is turned on.

A red bar is displayed when transmitting.

③ Tag display area

“VFO” is displayed in the VFO mode.

The memory channel number and the tag are displayed in the memory mode.

④ Frequency display area

In the memory mode, pressing  for one second or longer will display the memory channel tag.

⑤ VOL/SQL level display area

⑥ S-meter/transmit power level display, and also partner station information display

⑦ Clock/Voltage display area

⑧ Icon display area

Bluetooth, APRS, micro-SD card and GPS icons are displayed when each function is in use.

⑨ Communication mode display area

The analog and digital modes are indicated using symbols.

A red bar will be displayed above the symbol in the AMS (auto mode). The AMS automatically matches the communication mode of the received signal.

* Digital communications can operate in Band A only.

● Dual band screen

Band A and Band B will be displayed at the top and bottom.



[V/M] The VFO channel and memory channel will be switched by touching this symbol. The “V” is displayed in orange in the VFO mode while the “M” is displayed in orange in the memory mode.

[SQL] The squelch level can be set after touching this symbol. The characters are displayed in orange for 5 seconds during the time that the squelch level can be set.

[MUTE] The receive audio can be muted by touching this. The characters are displayed in orange when the sound has been muted.

[SCOPE] The band scope operation toggles on or off each time this symbol is touched. The characters are displayed in orange during the band scope operation.

● Band scope screen

The screen appears as shown, when the band scope is turned on.

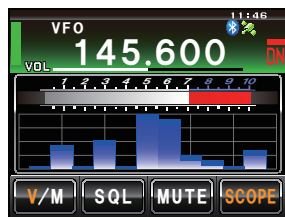

Tip The width of the band scope can be set to either “WIDE” or “NARROW” under **[DISPLAY]→[4 BAND SCOPE]** in the set-up menu.

● Function menu screen

When **[F₁]** is pressed, the function menu is displayed on the screen under the operating band.

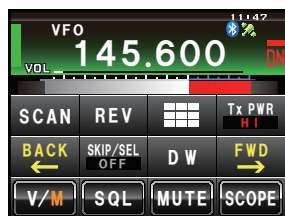

[BACK][FWD] The menu changes each time these symbols are touched.

Tip The functions displayed in the menu can be assigned to the touch keys at the bottom of the display. Refer to Page 125 for details.

Change the display mode

The display mode will switch in the sequence each time  is pressed.

Frequency display screen→Compass/Lat&Lon display screen→Altitude display screen*→Timer/Clock screen*→GPS screen*

*This screen will be displayed when **[DISPLAY]**→**[1 DISPLAY SELECT]** is set to “ON” in the set-up menu.

● Compass screen

The direction of travel of your own station and direction coordinate of the received station are displayed in the compass screen.



COMPASS Displays the compass settings. There are two settings, “Heading Up” where the direction of travel is on top, and “North Up” where North is always on top.

Refer to “Change the Compass Settings” (P.98) for details.

DISTANCE When a saved position information is recalled, the distance from the current position is displayed.

[YR] When this symbol is touched, the position of the partner station that is received is displayed in the compass (when the position information is included in the signal), and the symbol is shown in orange.

[MY] When this symbol is touched, the direction of travel of your own station is displayed in the compass, and this symbol is displayed in orange.

[MEMORY] When this symbol is touched, the position information being displayed is saved in the memory.

[★] When this symbol is touched while the display is green, the position information saved in the memory under the tag “★” is displayed. When this symbol is touched while the display is blinking, the position information displayed in the compass will be saved in the memory under the tag “★”.

[L1] When this symbol is touched while the display is green, the position information saved in the memory under the tag “L1” is displayed. When this symbol is touched while the display is blinking, the position information displayed in the compass will be saved in the memory under the tag “L1”.

[L2] When this symbol is touched while the display is green, the position information saved in the memory under the tag “L2” is displayed. When this symbol is touched while the display is blinking, the position information displayed in the compass will be saved in the memory under the tag “L2”.

● Altitude display screen

The altitude of the current location is shown in the bar graph display.

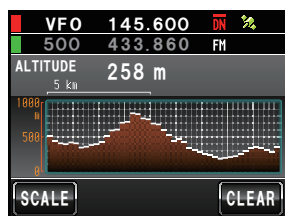

ALTITUDE Displays the current altitude.

Vertical axis Represents the altitude.

Horizontal axis

Represents the distance.

[SCALE] When this symbol is touched, the scale of the distance changes.

[CLEAR] When this symbol is touched, the graph display will be cleared (erased).

● Timer/Clock screen

The current time is shown in analog and digital formats. The date is also shown.



[MODE] The mode switches between the lap timer mode and the countdown timer mode each time this symbol is touched.



● Lap timer screen

- [START] The count starts when this symbol is touched.
- [LAP] The lap time is then saved in the memory (a maximum of 99 lap times can be saved) and displayed in the upper lap display window when this symbol is touched.
The lap time (of the new interval) being measured will be displayed in the lower lap display window.
- [STOP] The count stops when this symbol is touched.
- [RECALL] When this symbol is touched, the lap time saved in the memory is shown in the upper lap display window while the split time is shown below. When there are multiple lap times, touch [▲][▼] to move between the lap times.
Touch [RECALL] again to return to the measurement screen.
- [RESET] The counter is reset when this symbol is touched.



● Count down timer screen

- [START] The count starts when this symbol is touched.
- [STOP] The count stops when this symbol is touched.
- [RESET] The counter is reset when this symbol is touched.
- [SETUP] The count time can be changed (from 1 minute to 99 hours and 59 minutes) when this symbol is touched. Each time this symbol is touched, the setting will switch from “Hours” to “Minutes” to “Confirm”. The time can be changed by touching [-] and [+] or turning .

● GPS screen

The GPS satellite statuses are shown with numbered icons.

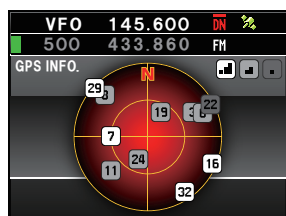

- 1, 2, etc. Received satellite number
- 1 Signal strength High
- 1 Signal strength Medium
- 1 Signal strength Low

Input the character

The keyboard screen is displayed when entering a memory channel tag or the call sign of your own station.

● Numbers and symbols input screen



- [ABC] The screen changes to the alphabet input screen when this symbol is touched.
- [123#%^] The screen changes to the input screen for numbers and symbols each time this symbol is touched.
- [←][→] The cursor in the input field moves left and right when these symbols are touched.
- [ENT] The entered characters are confirmed and the display returns to the previous screen when this symbol is touched.
- [BACK] The display returns to the previous screen when this symbol is touched.
- [X] One character to the left of the cursor is erased when this symbol is touched.

● Alphabet input screen



- [Caps] The input switches between small and capital letters input each time this symbol is touched.

Installing the Radio

Precautions during installation

Note the following when installing this radio.

- Do not install the radio in a place where there is extreme vibration, where there is a lot of dust, excessive humidity or high temperature, or where it is exposed to direct sunlight.
- Install the radio in a well ventilated position, so heat release is not obstructed because the heat sink gets hot when transmitting for a long periods of time.
- Do not place any objects on top of the main body.
- Do not lift up or hold the controller by holding the knob or control cable.
- A regulated, negative ground 13.8 V DC power supply is required for this radio.
Check that the car battery is a negative ground 12 V system when using this radio in a mobile unit. Never connect this radio to the 24 V battery of a large vehicle.
- Never connect this radio to a 120 V AC power source.
- Note that there is a risk that hum and noise may be introduced, depending on the installation condition and the external power source used.
- Install the device as far away as possible from the TV and radio to avoid TV and radio interference (TVI, BCI).
In particular, do not install this radio near indoor antenna elements.

Installation location when used in a mobile unit

● Controller

It is recommended that the controller be installed on top of the car dash board or in front of the center console. Refer to Page 28 on how to install the controller.

● Main body

It is recommended that the main body be installed below the car dash board or to the side of the center console. Refer to Page 27 on how to install the main body.

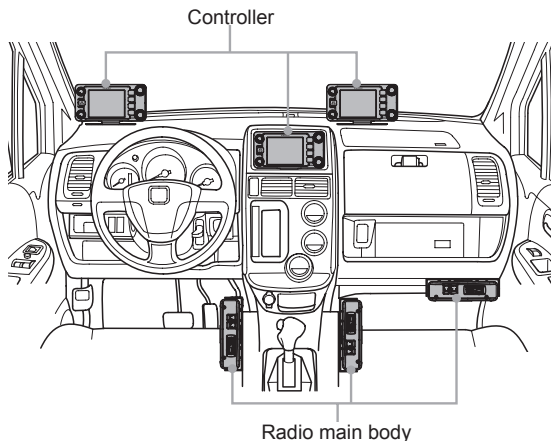

About the antenna

A good antenna installation is extremely important for transmission and reception purposes. Note the following, as the type and characteristics of the antenna largely determines whether the performance of the radio can be fully realized.

- Use an antenna that suits the installation conditions and application objective.
- Use an antenna that suits the operating frequency band.
- Use an antenna and a co-axial cable with a characteristic impedance of 50Ω .
- Adjust the VSWR (standing wave ratio) until it is 1.5 or less for an antenna with an adjusted impedance of 50Ω .
- Keep the co-axial cable routing length as short as possible.

Install the antenna

● Antenna installation in a mobile unit

Mount the antenna base at the rear of the car (rear bumper, trunk, rear gate, etc.) and then attach the antenna to the base.

Cautions

- Ensure that the antenna base is securely grounded to the car body.
- Avoid routing the co-axial cable enclosed with a commercial car antenna cable.
- Do not allow rain water or moisture to penetrate the cable or connectors when laying the co-axial cable inside the car.

Bumper type

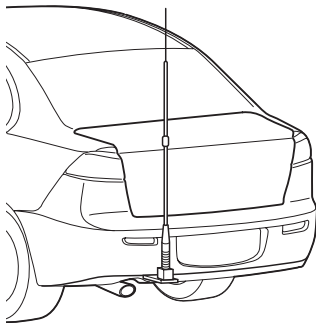

Trunk type

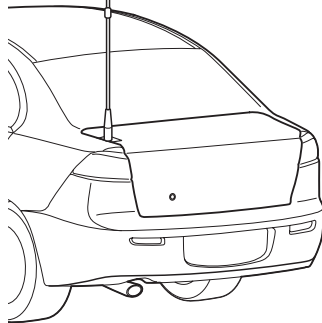

● Antenna installation in a fixed station

There are omni-directional, and directed array antennas for use in an outdoor setting.

- Omni-directional antennas such as the GP (Ground Plane) antenna are suitable for communications between a local station and mobile stations in all direction.
- Directional antennas such as the Yagi antenna are suitable for communications between a base station and a remote station in a specific direction.

Installing the Radio

Cautions

- Create a loop (slack) in the co-axial cable directly underneath the antenna and fasten it so that the weight of the cable does not pull on the antenna or connector itself.
- Install the antenna taking into consideration the securing supports and how the guying wires are positioned, so that the antenna does not fall over or get blown away in strong winds.

GP antenna

<Veranda Mounted Example>

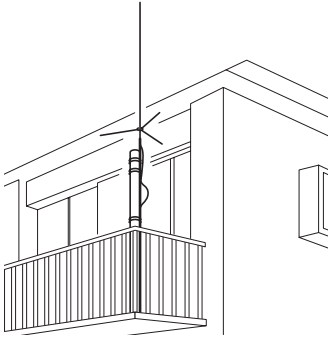

Yagi antenna

<Roof Mounted Example>

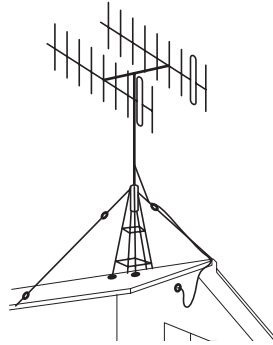

Installing the main body

Install the main body using the provided MMB-36 bracket.

1 Select the installation location

Caution Select a location where the antenna coax and power cable can be securely attached.

Tip Also refer to “Installation location when used in a mobile unit” (P.24).

2 Drill four 6 mm diameter holes in the location where the bracket is to be mounted, matching the positions of the bolting holes of the bracket

3 Attach the bracket using the provided bolts, nuts and washers

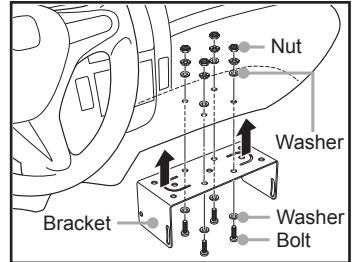

4 Fasten the main body to the bracket, using the provided flange bolts, as shown in the drawing

Tip The mounting angle can be changed depending on the securing position of the flange bolts.

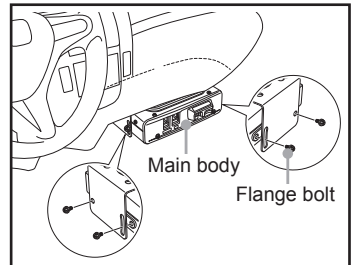

Installing the controller

Install the controller using the provided bracket.

Caution

The bracket can be bent by hand to match the location where the controller is going to be installed. Take due care not to injure yourself when bending the bracket.

1 Select the installation location

Caution Select a stable, flat location with as few dents and protrusions as possible.

Tip Also refer to “Installation location when used in a mobile unit” (P.24).

2 Fix the bracket to the controller using the provided screws and washers, as shown in the drawing

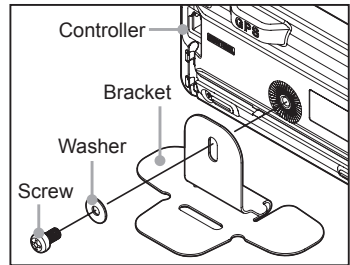

3 Peel off the protective seal from one side of the provided two-sided adhesive sheet, and paste it onto the bottom of the bracket

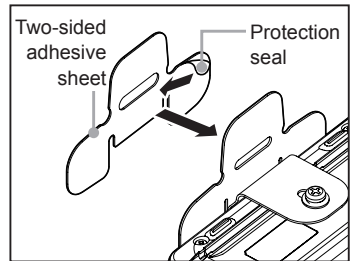

4 Peel off the other protection seal from the underside of the two-sided adhesive sheet pasted onto the bracket, and then stick the bracket to the installation location

Caution Remove all dirt and dust from the installation location before affixing the bracket.

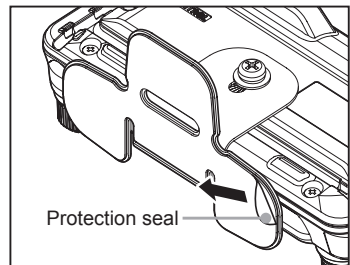

Connecting the Radio

Connecting the controller to the main body

Caution

Make sure the power supply is switched OFF before connecting the cable between the controller and the main body.

- 1 Plug the connector of the controller cable into the [CONTROL] jack at the front of the main body until a click sound is heard

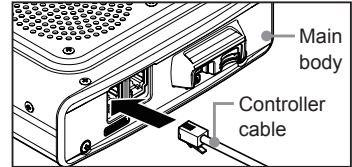

To reduce high frequency EMI/RFI electronic noise, place the Controller Cable through the supplied ferrite core.

Then snap the two halves of the core together, as shown in the illustration. Attach the ferrite core as close as possible to the connector, as shown.

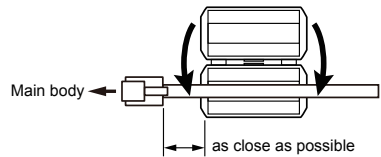

- 2 Plug the other connector of the controller cable into the [CONTROL] jack at the back of the controller until a click sound is heard

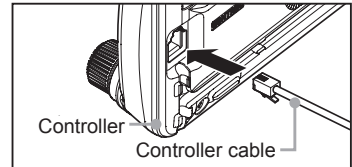

Connecting the microphone

- 1 Plug the microphone connector into the [MIC] jack at the front of the main body until a click sound is heard

Tips • To remove the microphone, pull the connector out while pressing the latch.

- A microphone extension cable (about 3 m long) is included in optional microphone extension kit "MEK-2". Use it to install the microphone in locations which cannot be reached by the attached microphone cable.

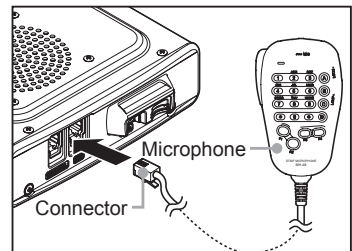

Connecting the antenna

- 1 Attach the antenna co-axial cable to the [ANT] terminal at the back of the main body and tighten the connector

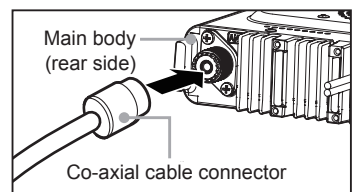

Connecting the Power Supply

Connecting the car battery

When using this radio as a mobile unit, connect the DC power supply cable to the negative ground 12 V car battery.

Cautions

- Use the radio in a car with a negative ground 12 V DC system, where the minus (-) pole of the battery is connected to the car body.
- Do not connect the radio to the 24 V battery of a large vehicle.
- Do not use the cigarette lighter inside the car as a power source.

(1) Cable routing from inside the car to the engine compartment

Rout the DC power supply cable to the engine compartment, passing it through a grommet in the fire wall from the passenger side.

- 1 Feed a hardened wire from the engine compartment through the grommet into the interior of the car
- 2 Hook the end of the “feed” wire with the “bare wire” end of the provided DC power supply cable
- 3 Fold and bend the ends of the wires and wind insulation tape around them
- 4 Pull the “feed” wire back into the engine compartment
The DC power supply cable will be pulled through the grommet into the engine compartment.
- 5 Peel off the tape and remove the DC power supply cable from the “feed” wire

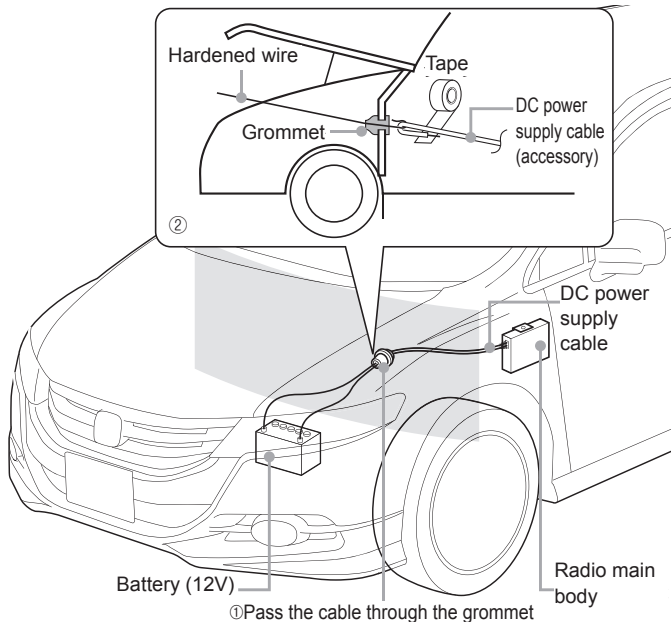

(2) Connecting the power supply cable

Cautions

- Do not use a DC power supply cable other than the one that is provided or specified.
- Do not route the DC power supply cable where objects may be placed on top of it or persons may step on the cable.
- Do not use the DC power supply cable with the fuse holder cut off.
- Do not reverse the polarity (positive and negative) when connecting the battery.

- 1 Disconnect the minus (-) terminal from the battery
This prevents short-circuiting the 12 V DC voltage while working on the cables.
- 2 Obtain commercially available terminals and crimp or solder both the red (+) and black (-) wire ends of the DC power supply cable

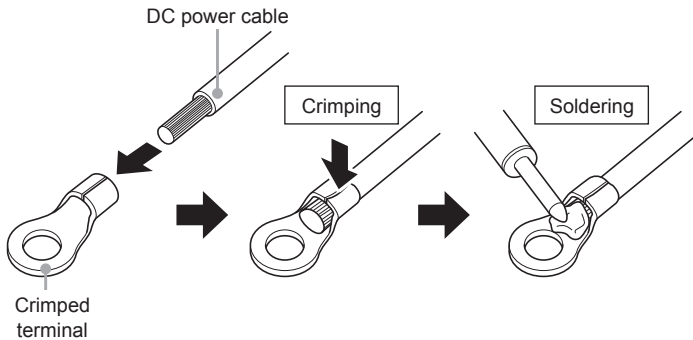

- 3 Connect the red wire (+) of the DC power supply cable to the positive (+) terminal of the battery

Caution Fasten the DC power supply cable securely so that the terminals do not get disconnected.

- 4 Reconnect the negative (-) terminal of the battery that was disconnected
- 5 Connect the black wire (-) of the DC power supply cable to the negative (-) terminal of the battery

Caution Fasten the DC power supply cable securely so that the terminals do not get disconnected.

- 6 Connect the DC power supply cable to the connector of the power cord of the main body

Press the plug into the connector until a click sound is heard.

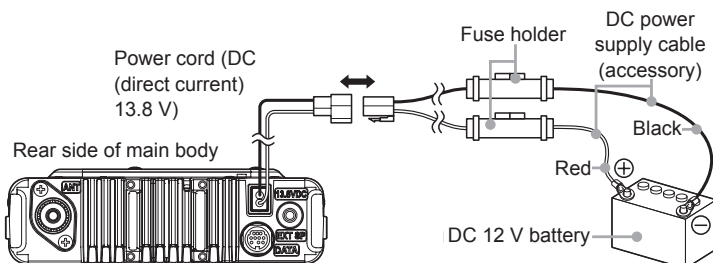

Connecting the Power Supply

Connecting the external power supply equipment

When using this radio as a fixed station, use an external 12 V DC power source.

Cautions

- Use an external power source capable of supplying DC 13.8 V, a current capacity of 20 A or more (FTM-400XDR/DE).
- Make sure to switch OFF the power of the external power source before connecting.

- 1 Connect the red wire (+) of the provided DC power supply cable to the positive (+) terminal of the external power source, and the black wire (-) to the negative (-) terminal of the external power source
- 2 Connect the DC power supply cable to the connector of the power cord of the main body

Press the plug into the connector until a click sound is heard.

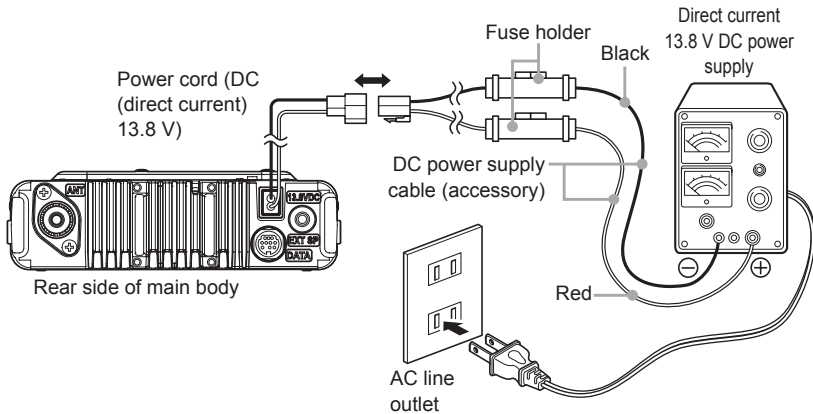

Setting Up the micro-SD Card

The following operations can be carried out by using a micro-SD card in this radio.

- Backing up the information and settings of the radio
- Saving the information in the memory channels
- Saving the settings in the set-up mode
- Saving the GPS log data
- Saving photos taken with the optional speaker microphone with camera “MH-85A11U”
- Saving data that has been downloaded using the GM function and WIRES-X function
- Exchanging the saved data among multiple radios

Micro-SD cards that can be used

2 GB, 4 GB, 8 GB, 16 GB and 32 GB micro-SDHC cards can be used in this radio.

Cautions

- The micro-SD or micro-SDHC cards are not provided with the product.
- Not all micro-SD and micro-SDHC cards sold commercially are guaranteed to work with this product.

Things to note when using micro-SD cards

- Do not bend the micro-SD card or place heavy objects on top of it.
- Do not touch the terminal face of the micro-SD card with your bare hands.
- Micro-SD cards that are initialized in other devices may not record normally when used in this device. Re-initialize the micro-SD card in this radio when using a card that has been initialized in another device. (Refer to Page 35 on how to initialize the memory card)
- Do not pull the micro-SD card out, or switch the power to the radio OFF when reading or writing data to the card.
- Do not insert anything other than a micro-SD card into the micro-SD card slot of the radio.
- Do not pull out or insert the micro-SD card with unreasonable force.
- When a single micro-SD card is used for a long period of time, writing and deletion of data may become disabled. Use a new micro-SD card when data can no longer be written or erased.
- Note that Yaesu shall not be liable for any damages suffered as a result of data loss or corruption in use of the micro-SD card.

Installing the micro-SD card

1 Press  for 2 seconds or longer to switch off the power to the main body

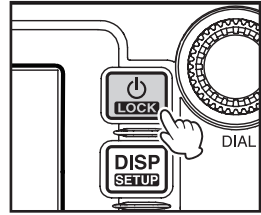

2 Insert the micro-SD card into the micro-SD card slot, with the terminal face on top, until a click sound is heard

- Cautions**
- Insert the micro-SD card in the correct direction.
 - Do not touch the terminal of the micro-SD card with your hands.

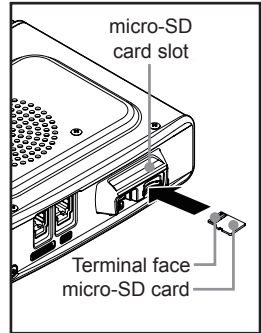

After the power is switched on, the "" icon will be displayed at the top right of the display.

Tip It may take a while for the icon to appear depending on the card capacity.

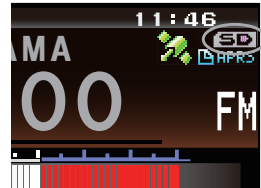

Removing the micro-SD card

1 Press  for 2 seconds or longer to switch off the power to the main body

2 Push in on the microSD card

A click sound will be heard and the micro-SD card will be pushed outward.

3 Pull the micro-SD card from the micro-SD card slot

Initializing the micro-SD card

When using a new micro-SD card, initialize the micro-SD card according to the following procedure.

Caution

Upon initialization, all the data recorded in the micro-SD card will be erased. Check the contents of the micro-SD card before initialization.

- 1 Press **[DISP SETUP]** for one second or longer
The set-up menu will be displayed.

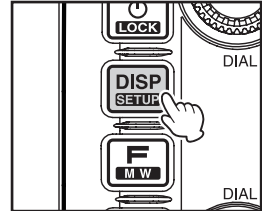

- 2 Touch **[SD CARD]**
The menu list will be displayed.

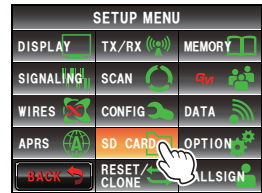

- 3 Touch **[2 FORMAT]**
The format confirmation screen will be displayed.

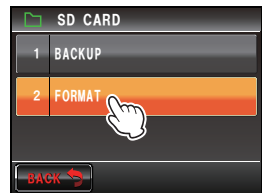

- 4 Touch **[OK?]**
The micro-SD card will be initialized.
Tip Touch **[Cancel]** to stop the initialization.
“Completed” will be displayed when initialization is completed and the screen will then return to the menu list.

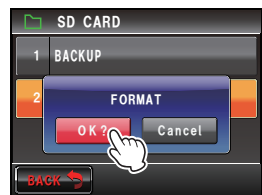

Receiving

Turning the power on

- 1 Press  for 2 seconds or longer

The power will be switched on, and the display will appear on the screen.

- Tips**
- When switching the power on for the first time after purchasing, or after resetting, a screen requesting the call sign of your own station be entered, will be displayed.
 - From the second time onwards, the call sign of your own station entered the first time will be displayed.

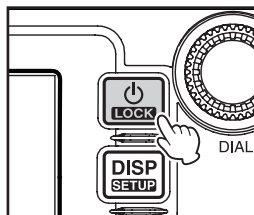

Switching the power off

- 1 Press  for 2 seconds or longer

The screen display will disappear, and the power will be switched off.

Inputting the call sign

When switching the power on for the first time after purchasing, or after resetting the device, a screen requesting the call sign of your own station be entered will be displayed.

The call sign is used to identify the transmitting station when communicating in the digital mode.

1 Touch the blinking [CALLSIGN]

- Tips** The display will change to the character input screen automatically if there are no operations for about 3 seconds.



2 Touch a character key

The touched character will be displayed at the top of the screen.

Enter each character of your call sign.

- Tips**
- Up to 10 characters (letters, numbers, and a hyphen) can be entered.
 - Refer to Page 23 on how to operate the character input screen.



3 Touch [ENT]

The screen will change.

Thereafter, the entered call sign is displayed at the bottom of the power on screen, and the display will switch to the frequency display screen (dual band screen).

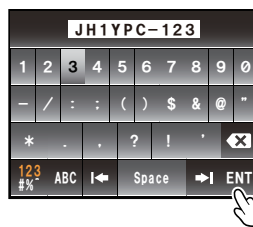

Switching the operating band

The two bands are displayed at the top and bottom of the dual band screen. The frequency and the modulation mode of the “operating band” can be changed. The band that is not in operation is called the “sub-band”.

- 1 Touch the frequency display area of the band that you would like to set as the operating band

The characters of the tag and frequency will be displayed in white. The sub-band characters will be displayed in gray.

Tip The operating band can also be changed by pressing .



Adjusting the volume

- 1 Turn 

The volume level will be displayed in the VOL meter below the frequency.

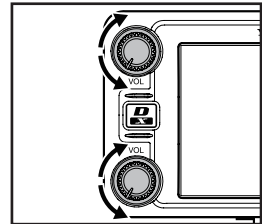

Adjusting the squelch level

Annoying noises can be muted when a signal cannot be detected. Band A and Band B squelch levels can be individually adjusted. Noise can be canceled more easily when the squelch level is increased but it may become more difficult to pick up weak signals. Adjust the squelch level as required.

1 Touch [SQL]

When [SQL] turns orange, the VOL meter below the frequency will change to show the SQL level setting.

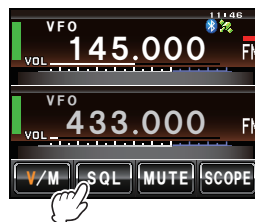

2 Turn to adjust the squelch level

The level will be displayed in the SQL meter.

Tip The SQL meter will return to the VOL meter if there is no operation for three seconds.

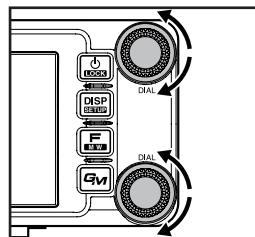

Tuning the radio

● Using the knobs

- 1 Turn 

The frequency will increase when the knob is turned in a clockwise direction and decrease when turned in a counter-clockwise direction.

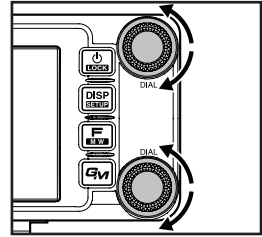

● Using the microphone keys

- 1 Press **[UP]** or **[DWN]**

The frequency increases when **[UP]** is pressed, and decreases when **[DWN]** is pressed.

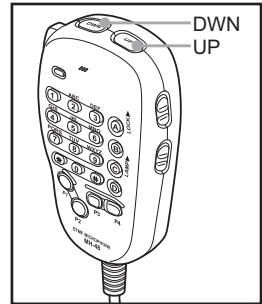

● Entering the numerical figures

- 1 Press 

The function menu will be displayed.

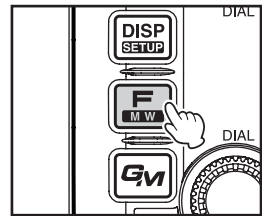

- 2 Touch 

The number input screen will be displayed.

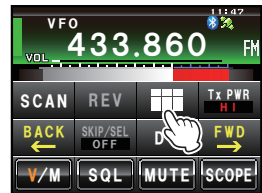

3 Touch a number key

The touched number will be displayed at the top of the screen.

Tip Refer to Page 23 for operation of the number input screen.



4 Touch [ENT]

The display will return to the function menu and the entered frequency of the operating band will be displayed at the top of the screen.

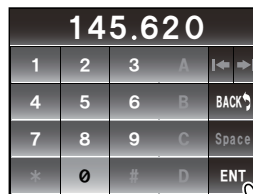

Changing the frequency steps

The frequency step while tuning with the knob or [UP]/[DWN] keys of the microphone, can be changed.

● **Changing the frequency step to 1 MHz temporarily**

- 1 Press **DIAL** of the operating band, or touch the frequency display area of the operating band
The MHz field in the frequency display will blink.

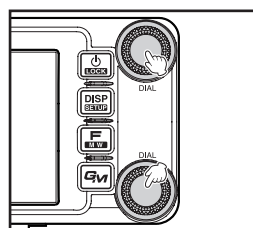

Receiving

2 Turn of the operating band

The frequency will change in 1 MHz steps

Tip When there is no operation for three seconds, the MHz field will stop blinking and the frequency step will return to the normal step.

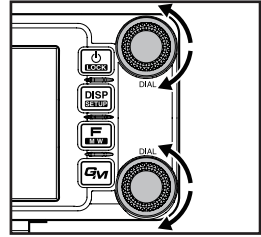

● Changing the frequency step to 5 MHz temporarily

1 Press for one second or longer

The kHz frequency digits will not be shown on the screen.

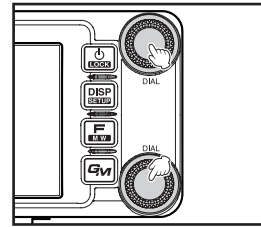

2 Turn 

The frequency will change in steps of 5 MHz.

Tip When there is no operation for three seconds, the kHz digits will be displayed and the frequency step will return to the normal step.

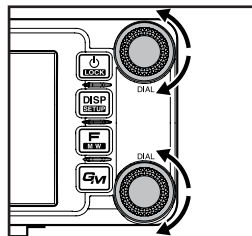

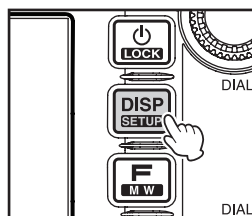

● Changing the frequency step using the set-up menu

- 1 Press  for one second or longer
The set-up menu will be displayed.

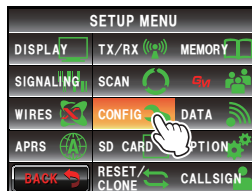

- 2 Touch [CONFIG]
The menu list will be displayed.



- 3 Turn  or touch the screen to select [7 FM AM STEP]

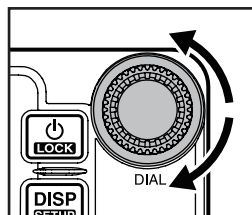

4 Touch [7 FM AM STEP]

The frequency step that is currently set up will change to orange.

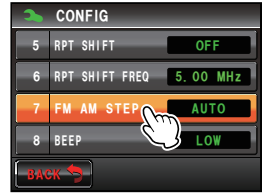

5 Turn  to select the frequency step

The setting will change in the following sequence:
 AUTO → 5.00 KHz → 6.25 KHz → 8.33 KHz (air band only) → 10.00 KHz → 12.50 KHz → 15.00 KHz → 20.00 KHz → 25.00 KHz → 50.00 KHz → 100.00 KHz

Tip Factory default value: AUTO

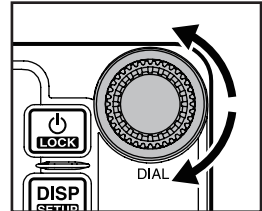

6 Touch [7 FM AM STEP]

The selected frequency step will be set, changing from orange to green.



7 Press  for one second or longer

The frequency step will be set and the display will return to the previous screen.

Tip The display can also be returned to the previous screen by touching [BACK] twice.

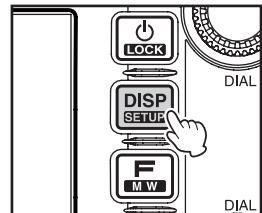

Switching the operating mode

The operating mode can be switched between the VFO mode where the frequency can be freely set, and the memory mode where the channels saved in the memory are recalled for operation.

1 Choose the operating band

2 Touch [V/M]

The mode will change to the memory mode.

The channel number will be displayed above the frequency.

The name (tag) assigned to the memory channel will also be displayed.

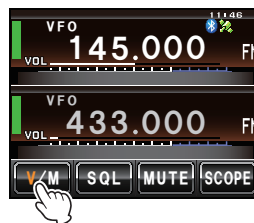

3 Touch [V/M] again

The mode will change to the VFO mode and the

frequency will return to the last frequency received.

“VFO” will be displayed above the frequency.



Switching the communication mode

This radio is equipped with an Automatic Mode Select (AMS) function which automatically selects any one of four communication modes to match the signal received.

Besides C4FM digital signals, analog signals are also identified in order to automatically match the communication mode of the partner station.

* Digital communication can be performed only on the Band A.

Press  to display “” on the screen.

* Display differs depending on the signal received.





— Display example when in the AMS

Receiving

When operating in a fixed communication mode, switch to the communication mode using .

The communication mode will switch in sequence as follows each time  is pressed.

“ (AMS)” → “DN (V/D mode)” → “VW/DW (FR mode)” → “FM (Analog)”

Operating mode	Display	Explanation of modes
AMS (Automatic Mode Select)		The operating mode is automatically selected from four communication modes to match the signal received. (The  part display differs according to the signal received) The AMS feature settings may be changed via Set-up Menu (P.178 Page Setting the AMS transmission mode).
V/D mode (simultaneous voice and data communication mode)	DN	As the audio signal error is detected and repaired at the same time as the transmission of the digital audio signal, it becomes more difficult for conversations to be cut off. A basic digital mode of C4FM FDMA.
Voice FR mode (Voice full-rate mode)	VW	Digital voice data is transmitted using the entire 12.5 kHz bandwidth. High quality voice communication is possible.
Data FR mode (high speed data communication mode)	DW	High speed data communication mode using the entire 12.5 kHz bandwidth for data communication. Automatically switches to this mode for video communication.
Analog FM mode	FM	Analog communication mode using the FM mode. This mode is effective for communication when the signal strength is so weak that the voice is cut off midway in the digital mode.

Caution

In the V/D mode (“DN” displayed), the position information is included in the transmitted signal during the conversation, but in the Voice FR mode (“VW” displayed), the position information is not included.

Switching the modulation mode

The modulation mode can be selected from “FM”, “NARROW FM” and “AM” in the analog mode.

When shipped from the factory, the mode is set to “AUTO” where the most optimal modulation mode is automatically selected according to the frequency.

- 1 Choose the operating band
- 2 Press  for one second or longer
The set-up menu will be displayed.

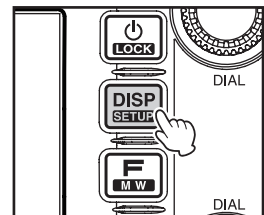

3 Touch [TX/RX]

The menu list will be displayed.

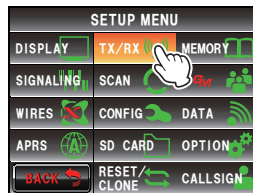

4 Touch [MODE] to select the modulation mode

The modulation mode changes in the following order each time the screen is touched:

“AUTO (FM)”: Automatically switches the modulation mode to match the frequency band

“FM”: Switches to the FM mode.

“NARROW FM”: Switches to the Narrow FM and Narrow Digital mode. The degree of modulation becomes half the normal level.

“AM”: Switches to the AM mode.

Tip Factory default value: AUTO (FM)

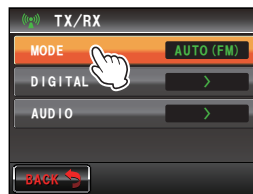

5 Press [DISP/STAB] for one second or longer

The modulation mode is set up and the display returns to the previous screen.

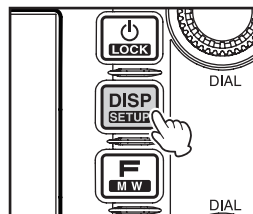

Displaying the band scope

The band scope can display a graph of the signal activity of the channels surrounding the memory channel or frequency that has been set up in the operating band. The display is centered on the current operating frequency.

1 Touch [SCOPE]

[SCOPE] will turn orange and the band scope will be displayed.

Tip The range to be shown can also be adjusted. Refer to “Setting the the band scope display width” (P.176).



- 2 Touch **[SCOPE]** again
The display will return to the dual band screen.

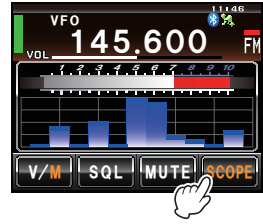

Muting the audio

The audio in the operating band and sub-band can be muted with just one touch.

- 1 Touch **[MUTE]**
[MUTE] will turn orange and the sound will become inaudible.

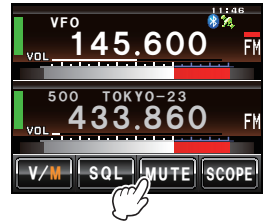

- 2 Touch **[MUTE]** again
The sound will become audible.

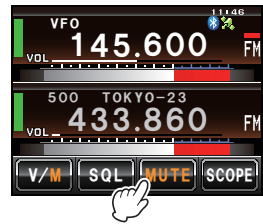

Transmitting

- 1 Press and hold the microphone [**PTT**]
A red bar will be displayed on the left of the band display.
Also, the transmission output level will be displayed in the PO meter under the VOL meter.
- 2 Talk directly into the microphone [**MIC**]
Tip Keep the microphone at a distance of about 1 inch away from the mouth when talking.

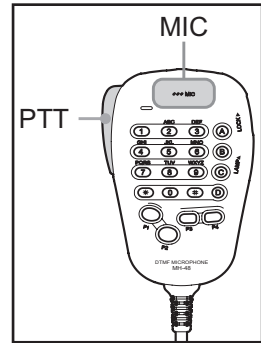

- 3 Release [**PTT**]
The red bar and PO meter level will disappear and the radio will return to the receiving state.

Tips

- Refrain from transmitting continuously for a long period of time as much as possible. The temperature of the main body will rise and this may result in burns and equipment failure due to overheating.
- "ERROR TX FREQ" will be displayed when attempting to transmit on a frequency that is not in the amateur band.



Adjusting the transmit power

When communicating with a nearby station, the transmit power can be reduced to save on energy consumption.

- 1 Press .
The function menu will be displayed.

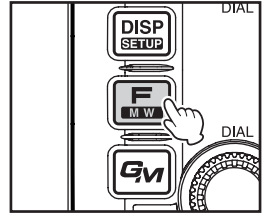

- 2 Touch **[Tx PWR]** to select the transmit power.
The transmission power is changed in the following sequence, each time **[Tx PWR]** is touched.
“HI” → “LO” → “MD”

Model	HI	MD	LO
FTM-400XDR/DE	50 W	20 W	5 W



- 3 Press .
The transmit power is set and the display returns to the previous screen.

Tips

- The current setting will be displayed under **[Tx PWR]** in the display.
- The default setting when shipped from the factory is “HI”.

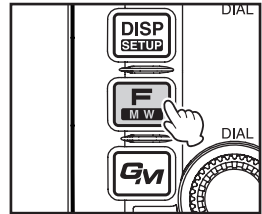

Adjusting the sensitivity of the microphone

The sensitivity (gain) of the microphone can be adjusted.

- 1 Press  for one second or longer.
The set-up menu will be displayed.

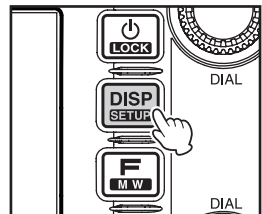

- 2 Touch **[TX/RX]**
The menu list will be displayed.

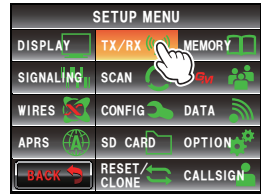

- 3 Touch **[AUDIO]**
The menu list will be displayed.

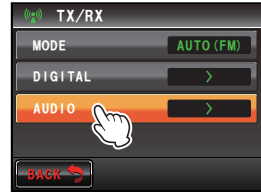

- 4 Touch **[3 MIC GAIN]** to select the sensitivity
The sensitivity will change in the following sequence each time the screen is touched.
“MIN” → “LOW” → “NORMAL” → “HIGH” → “MAX”
Tip • The sensitivity can also be selected by pressing .
• Factory default value: NORMAL



- 5 Press for one second or longer
The sensitivity is set and the display returns to the previous screen.
Tip The display can also be returned to the previous screen by touching **[BACK]** twice.

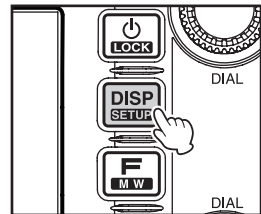

Communicating in the FM mode

- 1 Choose the operating band
- 2 Select “FM” as the modulation mode
- 3 Tune the radio using
- 4 Press and hold the microphone **[PTT]** to talk

Tip The Narrow FM mode can also be used. Set the mode to **[NARROW FM]** under **[TX/RX]** → **[MODE]** in the set-up menu.

Communicating using the repeater

This radio includes an ARS (Automatic Repeater Shift) function which permits communication through the repeater automatically just by setting the receiver to the repeater frequency.

- 1 Set the receive frequency to the repeater frequency
“-” or “+” appears on top of the display.
- 2 Press **[PTT]**, to begin communicating through the repeater

Tips

- Press **[REV]** and touch **[REV]** to reverse the transmission and reception frequencies temporarily to check whether direct communication with the partner station is possible.
- When reversing the frequencies, **[REV]** will turn orange.
- When **[REV]** is touched one more time, the reverse is cancelled.
- When the settings are changed in the set-up menu, this radio can be used in even more convenient ways.

The ARS function can be turned off under “CONFIG” → “4 AUTO RPT SHIFT”.

The repeater shift direction can be set under “CONFIG” → “5 RPT SHIFT”.

The repeater shift width can be changed under “CONFIG” → “6 RPT SHIFT FREQ”.

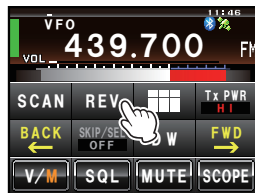

● Repeater shift

The FTM-400XDR/DE has been configured, at the factory, for the repeater shifts customary in the country where it is sold. For the 144 MHz band, this usually will be 600 kHz, while the 430 MHz shift will be 1.6 MHz or 7.6 MHz.

Depending on the part of the band in which you are operating, the repeater shift may be either downward (-) or upward (+), and one of these icons will appear on the display when repeater shifts have been enabled.

● Automatic repeater shift (ARS)

The FTM-400XDR/DE ARS feature causes the appropriate repeater shift to be automatically applied whenever it is tuned into the designated repeater sub-bands.

If the ARS feature does not appear to be working, you may have accidentally disabled it. To re-enable ARS:

- 1 Press **[DISP SETUP]** for one second or longer
The set-up menu will be displayed.

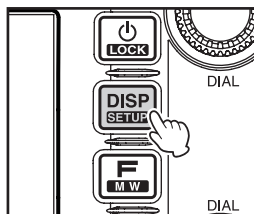

2 Touch **[CONFIG]**

The menu list will be displayed.

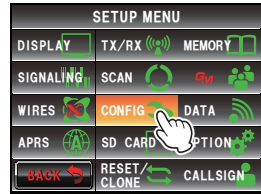

3 Turn , or touch the screen to select **[4 AUTO RPT SHIFT]**

4 Touch **[4 AUTO RPT SHIFT]** to select “ON”

The setting will switch between “ON” and “OFF” each time it is touched.



5 Press  for one second or longer

The automatic repeater shift will be set and the display will return to the previous screen.

Tip The display can also be returned to the previous screen by touching **[BACK]** twice.

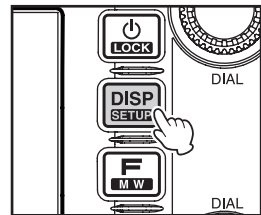

● **Tone Calling (1750 Hz)**

Press and hold in the program key **[P1]** of the microphone (MH-48) to generate a 1750 Hz burst tone to access the repeater. The transmitter will automatically be activated, and a 1750 Hz audio tone will be superimposed on the carrier. Once access to the repeater has been gained, you may release the [P1] key, and use the **[PTT]** for activating the transmitter thereafter.

Other Settings

Changing the beep volume

The volume of the confirmation beep that goes off when a key is pressed can be adjusted.

- 1 Press **[DISP SETUP]** for one second or longer
The set-up menu will be displayed.

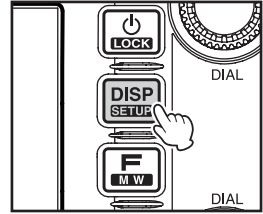

- 2 Touch **[CONFIG]**
The menu list will be displayed.

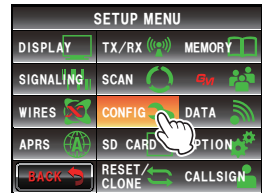

- 3 Touch **[8 BEEP]** to select the volume
The volume changes in the following sequence each time the screen is touched.
“OFF” → “LOW” → “HIGH”

Tip Factory default value: LOW

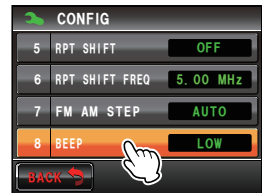

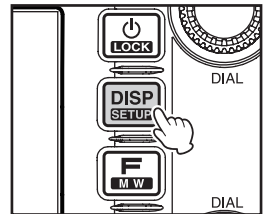

- 4 Press **[DISP SETUP]** for one second or longer
The beep volume will be set and the display will return to the previous screen.

Tip The display can also be returned to the previous screen by touching **[BACK]** twice.



Locking the knobs and switches

The knobs and switches etc. can be locked to avoid inadvertent changes and unintended operation.

- 1 Press  quickly
 “LOCK” will appear in the display and the display will return to the previous screen.
 Press  quickly one more time to cancel the lock.
 “UNLOCK” will appear in the display and the display will return to the previous screen.

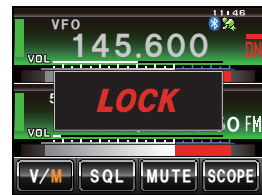
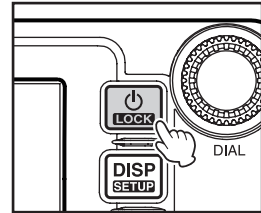

Adjusting the date and time

This radio has a built-in clock. Adjust the time before using.

- 1 Press **[DISP SETUP]** for one second or longer
The mode will change to the set-up mode.

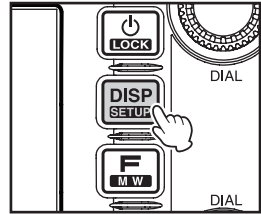

- 2 Touch **[CONFIG]**
The menu list will be displayed.

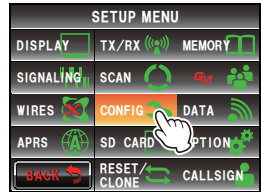

- 3 Touch **[1 DATA & TIME ADJUST]**
The screen for setting the date and time will be displayed.

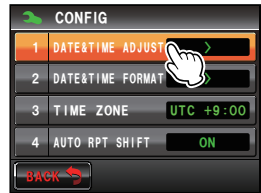

- 4 Touch **[SET]**
“Month” will blink.



- 5 Touch **[+]** and **[-]** to set the month



- 6 Touch **[SET]**
“Day” will blink.



7 Touch **[+]** and **[-]** to set the day



8 Touch **[SET]**
“Year” will blink.



9 Touch **[+]** and **[-]** to set the year



10 Touch **[SET]**
“Hour” will blink.



11 Touch **[+]** and **[-]** to set the hour



12 Touch **[SET]**
“Minute” will blink.



13 Touch **[+]** and **[-]** to set the minute



14 Touch [SET]



15 Press **[DISP SETUP]** for one second or longer

The date and time will be set and the display will return to the previous screen.

- Tips**
- The time will be displayed at the top right of the display.
 - You can also return to the previous screen by touching **[BACK]** three times.

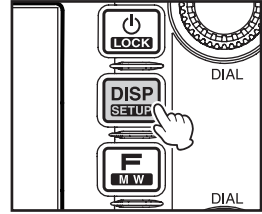

Tips

- The accuracy of the clock is ± 30 seconds per month at normal temperature. The accuracy may differ depending on the operating conditions such as temperature.
- The time is automatically set when signals are received from the GPS.
- When using this radio for the first time, the accuracy of the clock may occasionally be lower. In this case, adjust the time again.
- The calendar can display dates between Jan 1, 2000 and Dec 31, 2099.

Adjusting the display brightness

The brightness and contrast of the touch panel can be adjusted.

1 Press **[DISP SETUP]** for one second or longer

The set-up menu will be displayed.

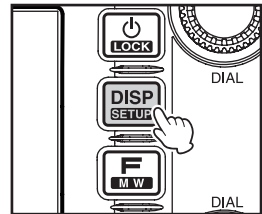

2 Touch **[DISPLAY]**

The menu list will be displayed.

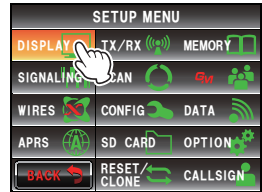

- 3 Select **[5 LCD BRIGHTNESS]** and touch the screen
The screen for selecting the level will be displayed.



- 4 Touch **[+]** and **[-]** to select the brightness level
The setting changes by one level each time the screen is touched. The brightness level can be selected from one of the following seven levels. "MIN", "2", "3", "4", "5", "6" and "MAX"

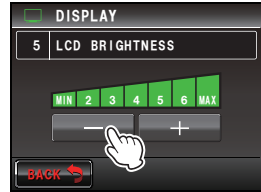

Tip Factory default value: MAX

- 5 Touch **[BACK]**
The brightness is set and the display returns to the previous screen.

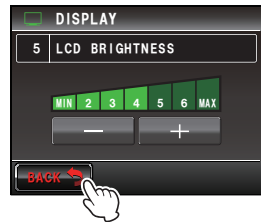

- 6 Select **[6 LCD CONTRAST]** and touch the screen
The screen for selecting the level will be displayed.



- 7 Touch **[+]** and **[-]** to select the contrast level
The setting changes by one level each time the screen is touched. The contrast level can be selected from one of the following seven levels. "-3", "-2", "-1", "0", "+1", "+2", "+3"

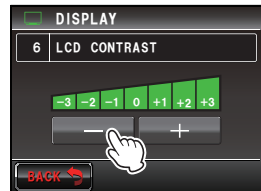

Tip Factory default value: +3

- 8 Press **[DISP SETUP]** for one second or longer
The contrast is set and the display returns to the previous screen.

Tip The display can also be returned to the previous screen by touching **[BACK]** twice.

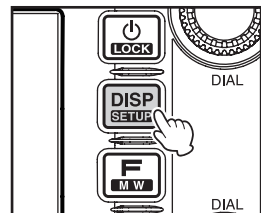

Changing the background color of the frequency display area

The background (shade) of the frequency display can be selected from five colors.

- 1 Press **[DISP SETUP]** for one second or longer
The set-up menu will be displayed.

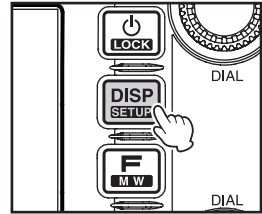

- 2 Touch **[DISPLAY]**
The menu list will be displayed.

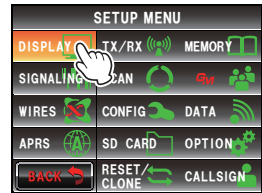

- 3 Touch **[3 BACKGROUND COLOR]** to select the color
The setting changes in the following sequence each time the screen is touched.
“ORANGE” → “GREEN” → “BLUE” → “PURPLE” → “GRAY”

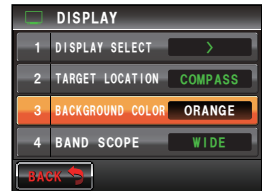

Tip Factory default value: ORANGE

- 4 Press **[DISP SETUP]** for one second or longer
The background color is set and the display returns to the previous screen.

Tip The display can also be returned to the previous screen by touching **[BACK]** twice.

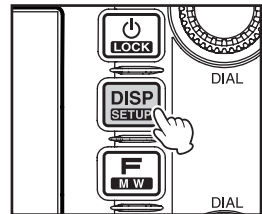

Reconfiguring the Settings

The settings and memory of this radio can be returned to be default factory settings when it was first shipped.

- 1 Press **[DISP SETUP]** for one second or longer
The set-up menu will be displayed.

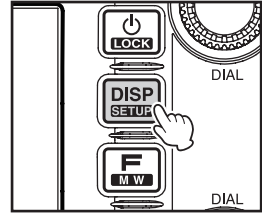

- 2 Touch **[RESET/CLONE]**
The menu list will be displayed.
The following resets can be selected.

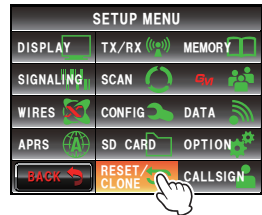

[1 FACTORY RESET]: This restores all settings to the default settings when shipped from the factory.

[4 MEM CH RESET]: This erases only the registered memory channels.
*Settings in the set-up menu will not be erased.

[6 APRS RESET]: This restores the APRS settings to the default value when shipped from the factory.

- 3 Touch the item to be reset
The reset confirmation screen will be displayed.



- 4 Touch **[OK?]**
The settings and memory will be reset and restored to the default status when shipped from the factory

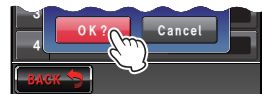

Tip Touch **[Cancel]** to stop the resetting.

Digital Group ID (DG-ID) feature

The DG-ID function can set up two-digit DG-ID numbers from “00” to “99” separately for Transmit and Receive. By setting both transmit and receive to “00” (default), you can communicate with all the other stations in the digital C4FM mode. By matching the transmit DG-ID number to the uplink DG-ID number set in club the DR-2X/XE System Fusion II digital repeater, you can access the digital repeater DR-2X/XE used in the club. For communication only among a group of friend’s transceivers, you can all match the same DG-ID number; then only your friend’s voices will be heard. Also, by using the GM function you can check whether stations with the same DG-ID are in the communication range.

Communicating only with the specific members by setting the DG-ID number except for “00”.

- 1 Press and hold **[GM]**.
The DG-ID number setting screen is displayed.
Tip While setting the DG-ID number, pressing and holding **[MSP]** will set the transmit and the receive DG-ID numbers to “00”.
- 2 Touch **[DG-ID TX]**.
The numbers of the set value will turn orange in color.
- 3 Rotate the **[DATA]** (upper side) to set the transmit DG-ID (DG-ID TX) to “50”.
- 4 Touch **[BACK]**, then rotate **[DATA]** (upper side), or touch the screen to select “DG-ID RX”.
“DG-ID RX” will turn orange.
- 5 Touch **[DG-ID RX]**.
The numbers of the set value will turn orange in color.
- 6 Rotate the **[DATA]** (upper side) to set the receive DG-ID (DG-ID RX) to “50”.

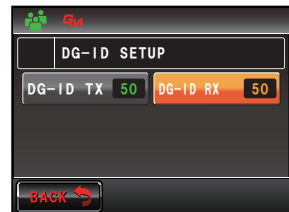

7 Press and hold **[GM]** to save the setting and return to normal operation.

- The group members with same DG-ID number may communicate with each other at the same frequency.
- The transmit and receive DG-ID number appears on the upper side of the LCD.

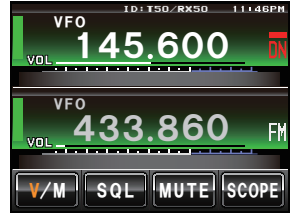

- Tip**
- The transmit and receive DG-ID default number is set to "00".
 - Normally, for general operation set the DG-ID number to "00" for both transmit and receive.

8 Press **[GM]** to turn the GM (Group Monitor) function ON, then you can check whether or not other Group Member stations are operating within communications range.

- The "GM" icon is displayed at the upper left of the display.
- The other stations also need to turn the GM function ON.
- While operating in the GM function, the call sign, the distance and the direction of a maximum 24 stations with the GM function turned ON, and that are within the communication range, may be checked.
- Rotate the **[FWD]** to select the other stations.



9 Press **[GM]** to turn the GM (Group Monitor) function OFF.

- Tip**
- Note that when the receive DG-ID number of your transceiver is set to a DG-ID number other than "00", received signals that do not have the same DG-ID number may not be heard.
 - The distance and direction information is displayed only when the position information is included in the signal of the other station.

Digital Personal ID (DP-ID) feature

Every C4FM digital transmit communication contains the individual ID information (Radio ID) of each transceiver. The DP-ID function uses this individual ID information. When communicating with another transceiver, if the DP-ID of the stations are registered in each other's transceivers, they can communicate even if the DG-ID numbers are different.

Registering the DP-ID to a DR-2X/XE digital repeater

Tip To register the transceiver DP-ID in the System Fusion II, DR-2X/XE C4FM digital repeater, refer to the instruction manual of the DR-2X/XE.

By registering the transceiver's DP-ID in the DR-2X, you can remotely control the settings and functions of DR-2X. Remote control cannot be performed from a transceiver that does not register the DP-ID, so it is possible to securely manage repeaters.

DR-2X Remote Control Feature

- Activate the repeater operation
- Deactivate the repeater operation
- Set the repeater to C4FM mode
- Set the transmit power
- Voice Message Control (Rec / Play / Stop)
- Set the Emergency Call

Registering the transceiver

- 1 Press  to enter the Set-up Menu.
- 2 Touch **[GM]**
- 3 Touch **[1 DP-ID LIST]**
The DP-ID List is displayed.

- 4 While the DP-ID list is displayed, a transmission in the digital C4FM mode from the other transceiver will register the DP-ID.

When a signal from the other station is received, the call sign and Radio ID are displayed on the LCD.

- Tip**
- When a signal from the already registered transceiver is received, the display of DP-ID LIST does not change.
 - When registering a transceiver already registered with a different call sign, the call sign registered in the DP-ID list is changed to registrar the new call sign.



- 5 Touch **[OK?]** to save the setting.
 - When registering in the DP-ID list is finished, then the display returns to the DP-ID list screen.
 - To continue operating without registering the DP-ID, touch **[Cancel]**.
 - If registering several DP-IDs, repeat step 4 to 5.
 - A maximum of 24 stations may be registered.



- 6 Press and hold **[DISP MENU]** to return to normal operation.
 Register the DP-ID of all the transceivers in the group to another transceiver using the other station by the same operation.

Tip • Once the DP-ID is registered, the DP-ID is stored until the DG-ID is deleted.

 - Register with another transceiver while each other's transceivers are nearby.

Deleting the registered DP-ID

- 1 Press **[DISP MENU]** to enter the Set-up Menu.
- 2 Touch **[GM]**
- 3 Touch **[1 DP-ID LIST]**
 The DP-ID List is displayed.



- 4 Rotate the **CALL** (upper side), or touch the screen to select the call sign.
- 5 Press the **CALL** (upper side).
 The confirmation screen is displayed.
- 6 Touch **[OK?]** to delete.
 - When deleting in the DP-ID list is finished, then the display re-returns to the DP-ID list screen.
 - To return to normal operation without deleting the DP-ID, touch **[Cancel]**.
 - If deleting several DP-IDs, repeat steps 4 to 6.
- 7 Press and hold **[DISP MENU]** to return to normal operation.



Using the Memory

Frequently used frequencies and settings can be saved in the memory so that you can quickly and conveniently operate on present channel. The radio is also equipped with the following memory functions:

- Skips memory channels that you do not wish to receive during scanning (☞P.81)
- Scans only the specified memory channels (☞P.80)
- “Programmable Memory Scan (PMS)” that scans only the specified frequency range (in the same frequency band) (☞P.83)

The operating frequency and other operational information can be registered to each regular memory channel, home channel, or PMS memory channel:

- Operating frequency
- Memory tag
- Repeater information
- Tone information
- DCS information
- Transmission power
- Memory skip information

(The operating mode information is not registered to the memory channels)

Writing to the memory

Tip

The information saved in the memory may be lost due to incorrect operation, static electricity or electrical noise. Data may also be lost due to component failures and repairs. Make sure to write down the information registered in the memories on a piece of paper or by using a micro-SD card.

A total of 500 channel memories each, can be used for Band A and Band B.

- 1 Switch to the VFO mode
- 2 Use **⊕** to adjust the frequency to be written in the memory

- 3 Press **MEM** for one second or longer

The memory writing screen will be displayed.

The frequency will be automatically displayed in the next empty memory channel.

Tip Refer to Steps 3 to 11 in “Naming the memory” (☞P.70) when assigning a name to a memory channel.

- 4 Turn **⊕** to select a different (if desired) memory channel

Tip The memory channel can also be selected by touching it directly.

- 5 Press **MEM** to save the data to memory

When the memory writing is completed, the frequency and memory channel number will be shown in the display.

Tips

- The frequency that is already written in the memory can also be overwritten by a new frequency.
- Touch **[V/M]** to return to the VFO mode.



Tips

- When shipped from the factory, the frequency in memory channel 1 of Band A is set to 144.000 MHz while the frequency in memory channel 1 of Band B is set to 430.000 MHz. These can be changed to other frequencies but cannot be erased.
- Names can also be assigned to the memory channels (P.70).
- 9 pairs of PMS memory channels can be written for Band A and Band B each (P.83).

Recalling the memory

- 1 Touch **[V/M]** to switch the mode

The memory channel last used will be shown in the display.

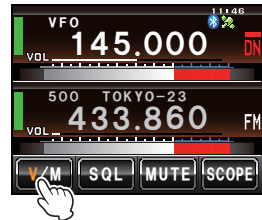

- 2 Turn **⌚** to select the memory channel
Touch **[V/M]** again to return to the VFO mode.

Tip

Non-registered memory channels will be skipped.

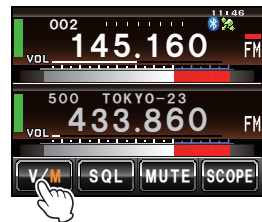
**Recalling the home channel**

- 1 Press **[F.MENU]**
The function menu will be displayed.
- 2 Switch the menu using **[BACK]** and **[FWD]**



Using the Memory

3 Touch [HOME]

The home channel will be shown in the display.

Tip Change the frequency using  to return to the VFO mode.

Touch [HOME] again to return to the VFO mode and display the frequency that was selected before the home channel was recalled.

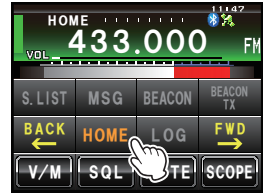
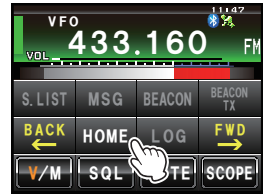



Tip



When shipped from the factory, the frequency in the home channel of Band A is set to 144.000 MHz while the frequency in the home channel of Band B is set to 430.000 MHz.

Changing the frequency of the home channel

The default frequency setting of the home channel when shipped from the factory can be changed.

- 1 Switch to the VFO mode
- 2 Adjust the frequency using 
- 3 Press  for one second or longer
The memory writing screen will be displayed.



- 4 Turn  to select [HOME]
- 5 Press 
The overwrite confirmation screen will be displayed.



- 6 Touch **[OK?]** to confirm and store the home channel frequency

When the writing to the home channel is completed, the updated home channel frequency will be displayed.

Tip Touch **[Cancel]** to stop writing.



Erasing the memory

- 1 Touch **[V/M]** for 2 to 3 seconds
The memory list will be displayed.
- 2 Turn  to select the memory to be erased

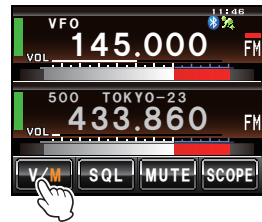

- 3 Touch **[DEL]**
The erase confirmation screen will be displayed.

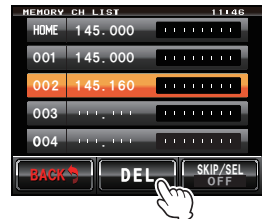

- 4 Touch **[OK?]** to confirm and delete the data
The memory will be erased, and the display will become an empty field.

Tips

- Touch **[Cancel]** to cancel the memory deletion.
- Repeat Steps 2 to 4 to erase additional memories.



Caution

Memory channel 1 and the home channel cannot be erased.

Naming the memory

Names (memory tags) such as call signs and the names of the broadcasting stations can be assigned to the memory channels and home channel.

Up to eight of the following characters can be entered as a memory tag.

- English letters (capital/small letters), numbers, symbols

Example: Assigning a name like “YM Grp01”

- 1 Touch [V/M] for 2 to 3 seconds

The memory list will be displayed.



- 2 Select the memory channel the name is going to be assigned to

Tip Select the home channel when assigning a name to the home channel.

- 3 Press **[F.MEMO]** for one second or longer

The character input screen will be displayed.

Tip Touch the memory channel or press **[MEMO]** for one second or longer to display the character input screen.

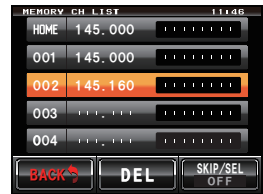

- 4 Touch **[Caps]** first, and then touch **[Y]** and **[M]**

[Caps] will turn orange, enabling capital letters to be entered.



- 5 Touch **[Space]**

- 6 Touch **[G]**



- 7 Touch **[Caps]** first, and then touch **[R]** and **[P]**

[Caps] will turn white, enabling lower case letters to be entered.



8 Touch [123]

The number and symbols input screen will be displayed.

9 Touch [0] and then [1]**10 Touch [ENT]**

The name will be stored in memory and displayed on the right side of the frequency.

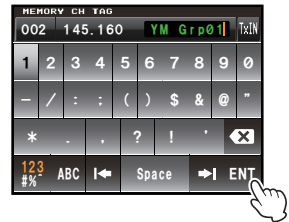
**11 Touch [BACK]**

The display will return to the previous screen.

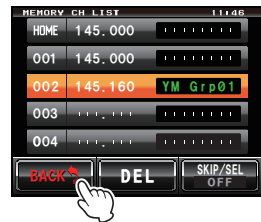
**Changing the method of the memory tag display**

The method of displaying the frequency and name assigned to the memory can be selected for each channel.

- 1** Switch to the memory mode
- 2** Select the memory channel that you want to change the memory tag display method on
- 3** Press **[MSP MENU]** for one second or longer
The set-up menu will be displayed.
- 4** Touch **[MEMORY]**
The menu list will be displayed.

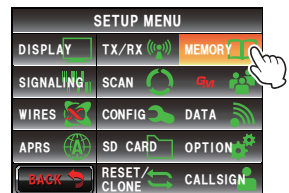

Using the Memory

- 5 Touch [1 ALPHA TAG SIZE] to select the memory tag display size

The setting will switch between “SMALL” and “LARGE” each time it is touched.

“SMALL”: Display the memory tag in small-sized characters and the frequency in large-sized characters.

“LARGE”: Display the memory tag in large-sized characters and the frequency in small-sized characters.

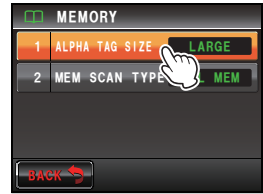

Tip Factory default value: LARGE

- 6 Press [DISP/TEMP] for one second or longer

The size of the memory tag display will be set and the display will return to the previous screen.

Tip The display method can also be changed by pressing [MEM] for one second or longer in the memory mode.

LARGE



SMALL



Split memory

Separate frequencies for transmit and receive can be registered for each memory channel.

● Simultaneous registration

- 1 Select the receive frequency in the VFO mode
2 Press [F] for one second or longer

The memory writing screen will be displayed.

- 3 Press [F] for one second or longer

The character input screen will be displayed.

Tip Refer to Steps 4 to 11 in “Naming the memory” (P.70) when assigning a name to a memory channel.

- 4 Touch [TX IN]

The number input screen will be displayed.



5 Enter the transmit frequency

The entered frequency will be displayed on the right side of [T] at the top of the screen.



6 Touch [ENT]

The display will return to the memory writing screen.



7 Turn to select the memory channel

Tip The memory channel can also be selected by touching it directly.

8 Press to save the transmit frequency

When the memory writing is completed, the receive frequency will be shown in the display.

● Registering transmit frequency at a later time

1 Touch [V/M] for 2 to 3 seconds

The memory list will be displayed.



2 Select the memory channel whose transmit frequency is to be registered

3 Press for one second or longer

The character input screen will be displayed.

- Tips**
- Touch the memory channel or press  for a second or longer to display the character input screen.
 - Refer to Steps 3 to 11 in "Naming the memory" (P.70) when assigning a name to a memory channel.



Using the Memory

4 Touch [TX IN]

The number input screen will be displayed.



5 Enter the transmit frequency

The entered frequency will be displayed on the right side of [T] at the top of the screen.



6 Touch [ENT]

The display will return to the memory list.

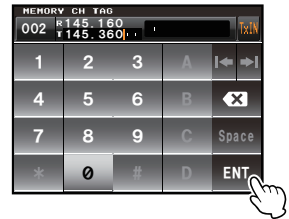

7 Press to save the transmit frequency

When memory writing is complete, the receive frequency will be shown in the display.

Receiving Weather Broadcast Channels (USA version only)



This radio includes the preprogrammed VHF Weather Broadcast Station Memory Channel Bank, and can receive the broadcast or the weather alert by recalling or scanning a desired channel.

The following channels are stored in the weather station memory bank of this radio.

Channel No.	Frequency	Channel No.	Frequency
WX01	162.550 MHz	WX06	162.500 MHz
WX02	162.400 MHz	WX07	162.525 MHz
WX03	162.475 MHz	WX08	161.650 MHz
WX04	162.425 MHz	WX09	161.775 MHz
WX05	162.450 MHz	WX10	163.275 MHz

This “WX” function can only be used through the programmable keys [P1] to [P4] on the microphone.

Assigning the “WX” function to a programmable key on the microphone

- 1 Press  for one second or longer
The set-up menu will be displayed.
- 2 Select and touch **[CONFIG]**
The menu list will be displayed.
- 3 Select and touch **[10 MIC PROGRAM KEY]**
The setting screen for programmable keys on the microphone will be displayed.
- 4 Touch the key name (P1 to P4) where the WX function is going to be assigned
The functions that can be assigned will be displayed.
When the **[WX]** is not displayed, turn  to scroll the display.
- 5 Select and touch **[WX]**
- 6 Touch **[BACK]**
The display will return to the setting screen for programmable keys.

Recalling the weather channels

Example: When “WX” is assigned to [P1]

- 1 Press **[P1]** on the microphone
The WX function is activated, and the weather channel selected last time the WX function was activated will be displayed on the screen.
- 2 Turn  to select the other channels
- 3 Press the **[PTT]** button on the microphone to search for louder stations
Scanning of the channels stored in the weather station memory bank will start.
When the scanning pauses on a station, press the **[PTT]** button once to halt the scan, or press it twice to restart the scan.
- 4 Press the **[PTT]** button to finish the scan
- 5 Press **[P1]**
The WX function will be inactivated and the display will return to the previous screen.

Listening the weather alert

In the event of extreme weather disturbances, such as storms and hurricanes, the NOAA (National Oceanic and Atmospheric Administration) sends a weather alert accompanied by a 1050 Hz tone and subsequent weather report on one of the NOAA weather channels. You may disable to receive the weather alert tone using **[SIGNALING]→[9 WX ALERT]** in the set-up menu.

Signal Search

The FTM-400XDR/DE transceiver is equipped with a scanning function to search for memory channels and VFO frequencies for active signals.

Scanning can be performed using the following four methods:

VFO scan

Scan for all memory channels

Scan for specified memory channels

Scanning the programmable memories

Tip

The band scope function can be used to search for active channels and show a graph.

When **[SCOPE]** in the screen is touched, the strengths of the channels will be displayed in a graph, with the current frequency located in the center of the screen (P.47).

VFO scan

1 Select the band to be scanned, and switch to the VFO mode

2 Press **[F.M.]** briefly

The function menu will be displayed.

3 Touch **[SCAN]**

Tip When **[SCAN]** is not displayed in the function menu, touch **[BACK]** and **[FWD]** to switch the menu.

The scan will start from low to high frequency.



During scanning, the decimal point of the frequency display will blink.

When a signal is received, the scan will stop for three seconds before starting to scan again.

Tips • The scan can also be started by pressing the **[UP]** or **[DWN]** button on the microphone for one second or longer.

• The scanning direction (UP/DOWN) can be set using **[SCAN]**→**[2 SCAN DIRECTION]** in the set-up menu.

• The scanning direction can also be changed by pressing the **[UP]** or **[DWN]** button on the microphone or turning **[M]** during scanning.

• The action used to stop the scanning may be set using **[SCAN]**→**[3 SCAN RESUME]** in the set-up menu (refer to the next page).

• The squelch level may be adjusted using the following procedure during scanning.
Touch **[SQL]** → Turn **[VOL]**.

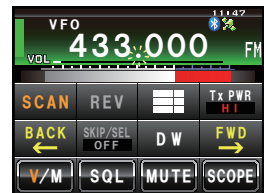

● To stop the scanning

To stop the scanning, either touch **[SCAN]** or press the microphone **[PTT]** button (the radio will not transmit in this case).

Setting the receive operation when the scanning stops

Any of the following three methods can be selected as the action to be taken after the scanning stops.

- (1) Restarts the scanning after receiving for the set amount of time. Select from one, three or five seconds.
- (2) Continues receiving until the signal disappears and then restart the scanning two seconds after the signal disappears (BUSY).
- (3) Stops the scanning to receive at that frequency (HOLD).

1 Press **[DISP/STAMP]** for one second or longer
The set-up menu will be displayed.

2 Touch **[SCAN]**
The menu list will be displayed.

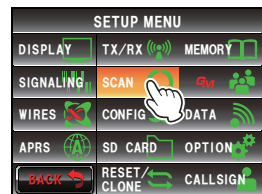

3 Touch **[3 SCAN RESUME]** to select the reception method

The reception method will change in the following order each time the screen is touched.

“BUSY” → “HOLD” → “1sec” → “3sec” → “5sec”

Tips • The reception method can also be selected by pressing



- Factory default value: 3 sec

4 Press **[DISP/STAMP]** for one second or longer

The reception method when the scanning stops will be set and the display will return to the previous screen.

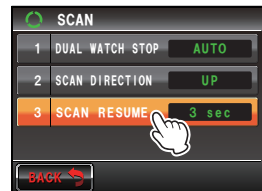

Tip

The settings here are applicable to “VFO Scan”, “Memory Scan” and “Programmable Memory Scan”.

Memory scan

The FTM-400XDR/DE transceiver will scan the frequencies registered in the memories in the order of the memory channel number.

1 Switch to the memory mode

2 Press  briefly

The function menu will be displayed.

3 Touch **[SCAN]**

Tip When **[SCAN]** is not displayed in the function menu, touch **[BACK]** or **[FWD]** to switch the menu.

The scanning will start from the lowest to the highest memory channel number.



During scanning, the decimal point of the frequency display will blink.

When a signal is received, the scan will stop for three seconds before starting to scan again.

Tips

- The scan can also be started by pressing the **[UP]** or **[DWN]** button on the microphone for one second or longer.

- The scanning direction (UP/DOWN) can be set using **[SCAN]**→**[2 SCAN DIRECTION]** in the set-up menu.

- The action to be taken when scanning is stopped can be set using **[SCAN]**→**[3 SCAN RESUME]** in the set-up menu (refer to the previous page).

- The squelch level may be adjusted using the following procedure during scanning.
Touch **[SQL]** → Turn 



● To stop the scanning

To stop the scanning, either touch **[SCAN]** or press the microphone **[PTT]** button (the radio will not transmit in this case).

Selecting the scanning method

The scanning may be set for all memories or only specified memories.

- 1 Press **[CHSP/CLAMP]** for one second or longer
The set-up menu will be displayed.
- 2 Touch **[MEMORY]**
The menu list will be displayed.

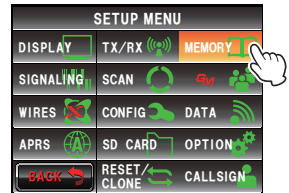

- 3 Touch **[2 MEM SCAN TYPE]** to select the scanning method
The setting will switch between “ALL MEM” and “SELECT MEM” each time it is touched.

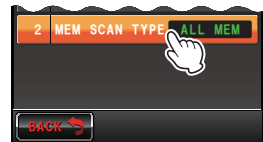

ALL MEM: Scan all memories.

SELECT MEM: Scan only specified memories.

- Tips**
- The scanning method can also be selected by pressing **[MEMA]**.
 - Factory default value: ALL MEM

- 4 Press **[CHSP/CLAMP]** for one second or longer
The scanning method will be set and the display will return to the previous screen.

Setting the specified memories

Specify the memories to be scanned when “2 MEM SCAN TYPE” is set to “SELECT MEM” in the set-up menu.

The memory can be specified using either of the following two methods:

- (1) Selects channels using the memory list screen
- (2) Specifies individual channels using the function menu screen

(1) Specify memory channels using the memory list screen

- 1 Touch **[V/M]** for 2 to 3 seconds (until the beep sounds)
The memory list screen will be displayed.



Signal Search

- 2 Select the memory channel to be specified by turning



Tip The memory channel may also be selected by touching it on the screen.

- 3 Touch **[SKIP/SEL]** to display “SELECT”

The setting displayed under **[SKIP/SEL]** will change in the following order each time it is touched.

“OFF” → “SKIP” → “SELECT”

Tip Repeat Steps 2 and 3 to specify the other memories next.

- 4 Touch **[BACK]**

Return to the previous screen, and “▶” will be displayed on the left side of the memory channel number.



(2) Specify individually using the function menu screen

- 1 Switch to the memory mode, and recall the memory channel to be set as the specified channel

- 2 Press **[F.M.]**

The function menu will be displayed.

- 3 Touch **[SKIP/SEL]** to display “SELECT”

“▶” will be displayed on the left side of the memory channel number.

Tip When **[SKIP/SEL]** is not displayed in the function menu, touch **[BACK]** or **[FWD]** to change the menu.

The setting displayed under **[SKIP/SEL]** will change in the following order each time it is touched.

“OFF” → “SKIP” → “SELECT”



Scan only the specified memory channels

- 1 First, select the band to be scanned, before switch to the memory mode

- 2 Press **[DISP/SCAN]** for one second or longer

The set-up menu will be displayed.

- 3 Touch **[MEMORY]**

The menu list will be displayed.

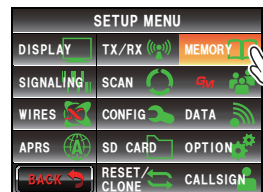

- 4 Touch **[2 MEM SCAN TYPE]** and select “SELECT MEM”

The setting will switch between “ALL MEM” and “SELECT MEM” each time it is touched.

- 5 Press **[CHSP/STAY]** for one second or longer
The display will return to the previous screen.

- 6 Press **[F.MENU]**
The function menu will be displayed.

- 7 Touch **[SCAN]**
The scan only those memory channels that have been set to “SELECT” will be started.

- Tip**
- The scan can also be started by pressing the **[UP]** or **[DWN]** button on the microphone for one second or longer.
 - The scan will be performed in increasing order of the memory channel number.
 - When a signal is received, the scanning stops for three seconds and then the scanning starts again.
 - To stop the scanning, either touch **[SCAN]** or press the microphone **[PTT]** button (the radio will not transmit in this case).

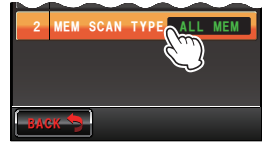

Setting the memories to be skipped

Memory channels which you do not wish to receive can be skipped during scanning.

The channels to be skipped can be set using the following two methods:

- (1) Designate channels using the memory list screen
- (2) Sets channels individually using the function menu screen

(1) Designating channels to be skipped using the memory list screen

- 1 Touch **[V/M]** for two to three seconds (until the beep sounds)
The memory list screen will be displayed.



- 2 Turn **[MEM.A]** to select the memory to be skipped
Tip The memory can also be selected by touching it directly.

Signal Search

3 Touch **[SKIP/SEL]** to display “SKIP”

The setting displayed under **[SKIP/SEL]** will change in the following order each time it is touched.

“OFF” → “SKIP” → “SELECT”

Tip Repeat Steps 2 and 3 to specify the other memories next.



4 Touch **[BACK]**

Return to the previous screen, and a blinking “▶” will be displayed on the left side of the memory channel number.

(2) Setting channels to be skipped individually using the function menu screen

1 Switch to the memory mode, and recall the memory channels that have been set to be skipped

2 Press **[F.M.]**

The function menu will be displayed.

3 Touch **[SKIP/SEL]** to display “SKIP”

A blinking “▶” will be displayed on the left side of the memory channel number.

Tip When **[SKIP/SEL]** is not displayed in the function menu, touch **[BACK]** or **[FWD]** to change the menu.

The setting displayed under **[SKIP/SEL]** will change in the following order each time it is touched.

“OFF” → “SKIP” → “SELECT”



Scanning the programmable memories (PMS)

Using the dedicated memory channel, only the frequencies within the specified frequency range will be scanned.

The frequency range is registered beforehand in the PMS memory channel.

Writing into the programmable memory

Nine pairs (P1L/P1U through P9L/P9U) of frequency ranges can be set up in the PMS memory channels.

Register the lower limit of the frequency range to be scanned into the memory channel "P*L" and the upper limit into the memory channel "P*U".

Memories with the same channel number "*" (a number from 1 to 9) are handled as one pair of PMS channel "P*".

Example: Set up a PMS channel by registering a lower frequency of 433.200 MHz and an upper frequency of 433.700 MHz in the P1 memory channel

- 1 Switch to the VFO mode
- 2 Select the frequency (433.200) to be set for the lower limit, using 



Caution The frequency to be set as the lower limit (P1L) must be lower than the upper limit (P1U).

- 3 Press  for one second or longer
The memory writing screen will be displayed.

- 4 Turn  to select [P1L]
The memory channel can also be selected by touching it directly.

Tip The memory channel can be assigned with an alpha-tag name (e.g. P.70).

- 5 Press 
The display will return to the previous screen, and the memorized frequency and memory channel number will be displayed.

- 6 Switch to the VFO mode
- 7 Select the frequency (433.700) to be set for the upper limit, using 
- 8 Press  for one second or longer
The memory writing screen will be displayed.

- 9 Turn  to select [P1U]
The memory channel can also be selected by touching it directly.

Tip The memory channel can be assigned with an alpha-tag name (e.g. P.70).



10 Press

The display will return to the previous screen, and the memorized frequency and memory channel number will be displayed.

Lower frequency P1L



Upper frequency P1U



Scanning the programmable memory

- 1 Switch to the memory mode
- 2 Recall the PMS memory of the upper frequency or lower frequency
- 3 Press  briefly

The function menu will be displayed.

4 Touch **[SCAN]**

Tip When **[SCAN]** is not displayed in the function menu, touch **[BACK]** or **[FWD]** to switch the menu.

The programmable memory scan will be started.

Tips

- The scan can also be started by pressing the **[UP]** or **[DWN]** button on the microphone for one second or longer.



- When a signal is received, the scanning stops for three seconds and then the scanning starts again.
- To stop the scanning, either touch **[SCAN]** or press the microphone **[PTT]** button (the radio will not transmit in this case).
- The squelch level may be adjusted using the following procedure during scanning.
Touch **[SQL]** → Turn 

Caution

When the upper and lower frequencies are not set correctly, the programmable memory scan will not work.

Monitoring the Home Channel

This radio is equipped with a dual receive function (also known as dual watch (DW)) which checks for a signal on the home channel approximately every three seconds while monitoring or scanning. If a signal is detected, the home channel is received for five seconds, and then monitoring or scanning with dual receive is resumed.

Example: When checking the home channel while receiving “145.500 MHz”



Reception frequency

Monitor the home channel at intervals of about three seconds.

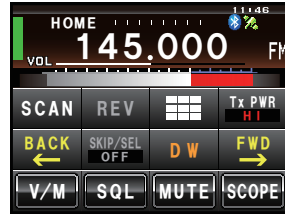



When the home channel is busy, the radio receives the signal for five seconds and then starts the dual receive again.

Caution

When shipped from the factory, the default frequency in the home channel of 144 MHz Band is set to 144.000 MHz while the default frequency in the home channel of 430 MHz Band is set to 430.000 MHz. These channels may be changed to a favorite operating frequency (P.68).

Using the dual receive

- 1 Tune in to the memory channel or a desired VFO receive frequency using 
- 2 Press  briefly
The function menu will be displayed.
- 3 Touch **[DW]**

Tip When **[DW]** is not displayed in the function menu, touch **[BACK]** or **[FWD]** to switch the menu.

Dual receive will start, and the home channel frequency will be received approximately every three seconds.

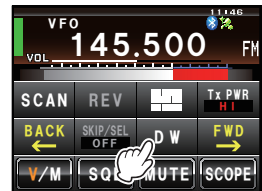

When a signal is detected on the home channel, it will continue to be received until the signal disappears.

● To cancel the dual receive

Touch **[DW]** again.

Setting the restart condition of dual receive

The dual receive restart condition when the home channel signal is detected can be selected from the following two ways.

- (1) Restarts dual receive after five seconds have passed (AUTO).
- (2) Stops dual receive and continue to receive the home channel (HOLD).

1 Press **[DISP/MENU]** for one second or longer
The set-up menu will be displayed.

2 Touch **[SCAN]**
The menu list will be displayed.

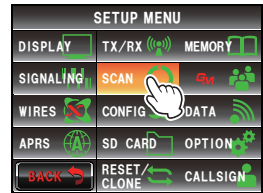

3 Touch **[1 DUAL WATCH STOP]** to select the restart condition

The setting switches between “AUTO” and “HOLD” each time it is touched.

Tip Factory default value: AUTO

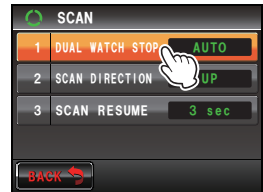

4 Press **[DISP/MENU]** for one second or longer
The dual receive restart condition will be set and the display will return to the previous screen.

Using the GPS Function

This radio is equipped with an internal GPS reception unit to receive and display the position information at all times. The position information can be used as in the following example.

Save the position information in the memory and use it for navigation purposes

- ☞ Refer to “Using the backtrack function” (Page 95)

Save the stations with frequent communications and checks whether they are within the sphere of communications

- ☞ Refer to the separate “Operating Manual GM Edition”

Exchange position information and messages through data communications with other stations

- ☞ Refer to the separate “Operating Manual APRS Edition”

What is GPS?

GPS or Global Positioning System is a satellite location system to determine the current position on earth. It is a military system developed by the US Department of Defense with approximately 30 GPS satellites circumnavigating the earth at an altitude of about 20,000 km. When signals from three or more satellites in space are received, the current position information (longitude, latitude, altitude etc.) may be determined within an accuracy of several meters. The accurate time can also be received from the atomic clock built into the GPS satellite.

Positioning Using GPS

- 1 Press  for one second or longer to switch on the power

The satellite search will begin and the “” icon will be displayed at the top right of the screen.

- Tips**
- It may take several minutes to capture the satellites.
 - When three or more satellites cannot be captured, the icon display will disappear. In this case, positioning is not possible and the position information cannot be used.

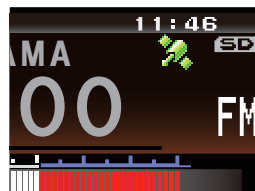

About GPS positioning

Positioning refers to the calculation of one's own position from the satellites orbit information and the transmission time of the radio waves. Positioning requires that three or more satellites be acquired. When positioning cannot be carried out properly, move to an open space as far away from buildings as possible and where there are fewer obstructions.

●About the error

Depending on the surrounding environment of the receiver location, an error of several hundred meters may occur. Although positioning is possible using only three satellites, depending on the positioning conditions, the positioning accuracy may become worse, or may no longer be possible under the following conditions:

- Between high rise buildings, narrow roads between buildings, indoors and under the shade of buildings, below high voltage lines and underneath overhead structures, between trees and shrubs such as in forests and woods, inside tunnels and underground, when used behind a solar-energy reflecting glass, locations where a strong magnetic field occurs

●When not using the radio for a long period of time

When using the GPS function for the first time after purchasing the FTM-400XDR/DE transceiver, and when turning it on after it has not been used for a long period time, positioning may take several minutes in order to search for the satellites. Also, when using the device again several hours after switching off the power, positioning may take several minutes in order to search for the satellites.

Positioning using an external GPS device

Commercial GPS receive devices can also be connected to the [EXT GPS] jack on the side of the controller.

The [EXT GPS] plug connector is illustrated below.

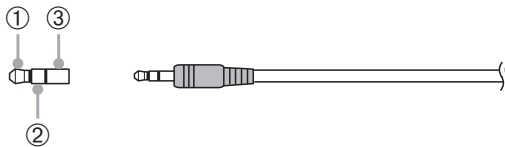

- ① TXD (serial data output [transceiver → external device])
- ② RXD (serial data input [transceiver ← external device])
- ③ GND

- 1 Switch off the power to the radio
- 2 Plug the connector of the external device into the [EXT GPS] jack on the side of the controller unit.

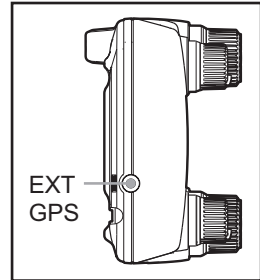

- 3 Switch on the power to the radio
- 4 Press **[DISP]** for one second or longer
The set-up menu will be displayed.
- 5 Touch **[CONFIG]**
The menu list will be displayed.

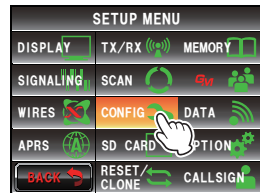

- 6 Touch **[17 GPS DEVICE]** to select "EXTERNAL"
Each time this symbol is touched, the setting will switch between "INTERNAL" and "EXTERNAL".



- 7 Press **[DISP]** for one second or longer
Return to the previous screen.

When the external device captures three or more satellites, the "📶" icon will be displayed on the top right of the screen.

Tips

- When connecting to an external GPS device, refer to the operating manual of the connected device as well.
- When using an external GPS device, keep the radio away from the external GPS device.
- When using an external GPS device, the data from the in-built GPS will become invalid.

Checking the satellite capture status

The satellites acquired at the current location and the strengths of the signals can be observed on the radar-like screen.

- 1 Press  for one second or longer
The set-up menu will be displayed.
- 2 Touch **[DISPLAY]**
The menu list will be displayed.

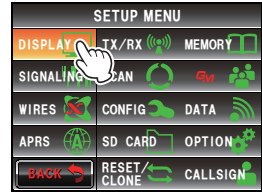



- 3 Touch **[1 DISPLAY SELECT]**
The screen for setting the various screens on and off will be displayed.

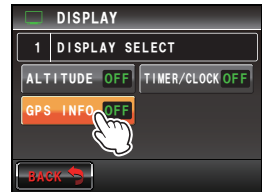

- 4 Touch **[GPS INFO]** to select "ON"
Each time this symbol is touched, the setting will switch between "OFF" and "ON".



- 5 Press  for one second or longer
The display will return to the previous screen.

- 6 Press  twice briefly
The radar-shaped GPS screen will be displayed and the acquired GPS satellite number and signal strength icon will be displayed.

The brighter the color of the icon, the stronger is the signal strength.

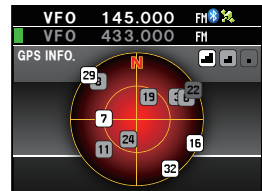

Tips • When the Altitude display screen and Timer/Clock screen are both "ON", the screen will change in the following order each time  is pressed.

Normal frequency display → Compass/Lat&Lon display screen → Altitude display screen → Timer/Clock screen → GPS screen

- When connecting an external GPS device, satellite information may not be output depending on the GPS device (in this case, the icon will not be displayed).

Displaying the position information

Displaying the current position information of your station

- 1 Press **[DISP]** for one second or longer
The set-up menu will be displayed.
- 2 Touch **[DISPLAY]**
The menu list will be displayed.
- 3 Touch **[2 TARGET LOCATION]** to select “NUMERIC”
Each time this is touched, the setting will switch between “COMPASS” and “NUMERIC”.
- 4 Press **[DISP]** for one second or longer
The display will return to the previous screen.
- 5 Press **[DISP]** briefly
The latitude and longitude display screen will be displayed.
- 6 Touch **[MY]**
The latitude and longitude of your station will be displayed in numerical figures.

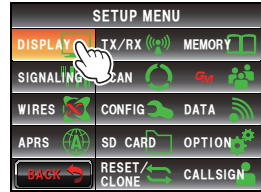

Tip When the Altitude display screen and Timer/Clock screen are both “ON”, the screen will change in the following sequence each time **[DISP]** is pressed.

Normal frequency display → Compass/Lat&Lon display screen → Altitude display screen → Timer/Clock screen → GPS screen

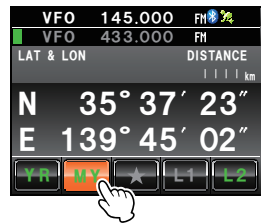

Displaying the position information of the partner station in the digital mode

In the C4FM digital V/D mode, the position and direction to the partner station can be displayed in real time during the communication. The position information obtained from the GPS is transmitted at the same time as the voice signal.

- 1 Switch the communication mode to AMS (auto mode select function) or digital mode, or activate the GM function
Tip Refer to “Using the GM function” (P.103) on the basic method of using the GM function.
- 2 Switch to the latitude and longitude display screen
- 3 Touch **[YR]**
The latitude and longitude of the partner station will be displayed in numerical figures.

Explanation of the position information screen

Example of a display of your own station position



- ① Latitude
 Displayed as “X DD°MM'SS”
 X: N (north latitude) / S (south latitude)
 DD: 0 - 90 (degrees)
 MM: 0 - 59 (minutes)
 SS: 0 - 59 (seconds)
 Example: N 35°37' 23” (latitude 35 degrees 37 minutes & 23 seconds)

Tip The “DD°MM'SS” and “DD°MM.MM” will switch each time the number section is touched.

- ② Longitude
 Displayed as “X DDD°MM'SS”
 X: E (east longitude) / W (west longitude)
 DDD: 0 - 180 (degrees)
 MM: 0 - 59 (minutes)
 SS: 0 - 59 (seconds)
 Example: E 139°45' 02” (east longitude 139 degrees 45 minutes 02 seconds)

Tip The “DDD°MM'SS” and “DDD°MM.MM” will switch each time the number section is touched.

Example of a display of a partner station position

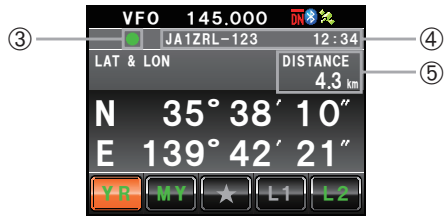

- ③ Position information status display
 The status display will indicate that the data received contains position information. The status display will blink when the GM function is activated.
Tip Refer to the separate Operating Manual GM Edition for the details on the GM function (download the manual from the YAESU website).
- ④ Partner station call sign and time of receipt
- ⑤ Distance to a partner station

Tip

Use [APRS] → [12 APRS UNITS] in the set-up menu to change the display units of the various data.

Recording the position information (GPS log function)

The position information of your own station can be recorded (saved) in a micro-SD card on a regular basis.

- 1 Press **[DNDP]** for one second or longer
The set-up menu will be displayed.
- 2 Touch **[CONFIG]**
The menu list will be displayed.

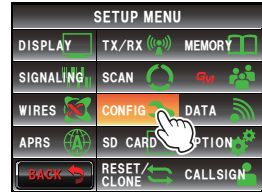

- 3 Select **[18 GPS LOG]** and touch the screen
The screen for selecting the recording interval and switching the GPS log function ON and OFF will be displayed.



- 4 Touch **[ON]**
The interval timing will be displayed in green characters.

- Tips**
- The position information will not be recorded when "OFF" is selected.
 - Factory default value: OFF

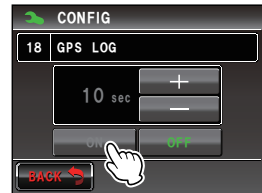

- 5 Touch **[+]** and **[-]** to select the interval timing
Each time the screen is touched, the interval timing will change in the following sequence. The interval timing can be selected from the following six levels.
"1 sec" "2 sec" "5 sec" "10 sec" "30 sec" "60 sec"

- Tip** Factory default value: 10 sec

- 6 Press **[DNDP]** for one second or longer
The interval timing for recording the position information will be set and the display will return to the previous screen.
The recording of the position information at the set interval will also be started.

Tips

- The position information will continue to be recorded until the power to the radio is switched off or when "OFF" is selected in Step 4. Recording will be restarted under the same file name when the power to the radio is turned on again, or when the recording interval is selected one more time in Step 5.
- The position data will be saved under the filename "GPSyymmdd.log". "yymmdd" shows the record start time in "yy" (year), "mm" (month) and "dd" (day) format.

Checking the route using a personal computer

The route can also be displayed with commercial map software using the log data of the saved position information.

- 1 Switch off the power to the radio
- 2 Remove the micro-SD card
- 3 Insert the micro-SD card into the personal computer card reader.
- 4 Open the “FTM400D” folder contained on the micro-SD card
- 5 Open the “GPSLOG” folder
The data is saved under the file name “GPSyymmdd.log”.
“yymmdd” refers to the recording start year (yy), month (mm), and day (dd).
- 6 Import the data into the commercial map software
The route will be displayed on the map.

Tips

- Refer to the operating manual of the map software that you are for instructions to import and display the route data on the map.
- The position information can also be used by connecting the radio directly to a computer (“Connecting to a personal computer” P.159).

Measuring the altitude

The changes in the altitude depending on the altitude of the current position and distance travelled can also be displayed in a graph.

- 1 Press **[DISP]** for one second or longer
The set-up menu will be displayed.
- 2 Touch **[DISPLAY]**
The menu list will be displayed.
- 3 Touch **[1 DISPLAY SELECT]**
A list of the various screen setting selections will be displayed.

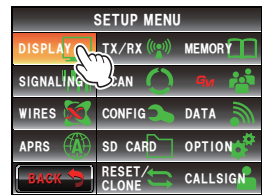

- 4 Touch **[ALTITUDE]** to select “ON”
Each time this symbol is touched, the setting will switch between “OFF” and “ON”.

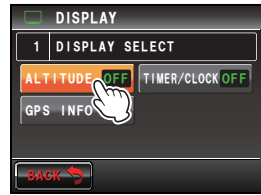

- 5 Press **[DISP/ENTER]** for one second or longer
The display will return to the previous screen.
- 6 Press **[DISP/ENTER]** twice briefly
The altitude graph will be displayed on the screen.



● Changing the altitude scale

- 1 Touch **[SCALE]**
Each time this symbol is touched, the scale value will change in the following order.
“5 m” → “20 m” → “40 m” → “80 m”
Tip The maximum altitude scale will be automatically set based on the present altitude values.

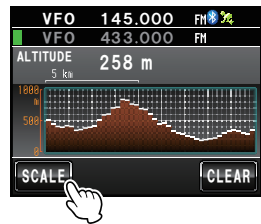

● Erasing the previous altitude changes

- 1 Touch **[CLEAR]**
The graph on the left side will disappear and the current altitude display will shift to the left end.

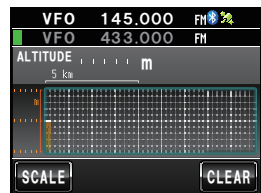
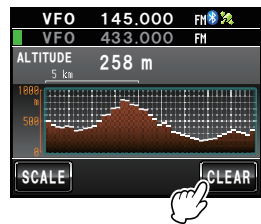

Other settings

● Changing the geodetic reference system

Select using **[CONFIG]** → **[16 GPS DATUM]** in the set-up menu.

Select the geodetic reference system which is the positioning standard.

“WGS-84”: Using the global geodetic reference system for positioning. This is being used as a standard all around the world.

“TOKYO MEAN”: Using the Japanese geodetic reference system for positioning. When positioning in Japan (Tokyo), the error can be lowered.

Tips

- When the geodetic reference system is changed, the position information will deviate by about 400 m.
- Set to “WGS-84” normally.

● Changing the time zone

Select using **[CONFIG]** → **[3 TIME ZONE]** in the set-up menu.

The time difference with the UTC (Coordinated Universal Time) can be changed in steps of 30 minutes.

Using the Smart Navigation Function

Two navigation methods may be used in the smart navigation function.

(1) Real-time navigation function

In the C4FM digital V/D mode, the position and direction of the received partner station can be displayed in real time during the communication because the position information obtained from the GPS is transmitted at the same time as the voice signal.

(2) Backtrack function

By registering the departure or other points in advance, the distance and direction from the current position to the registered location can be displayed in real time.

Displaying the Compass screen

When using the navigation function, use the “Compass Screen” to display the direction of your station and the partner station on a compass.

1 Press **[DISP]** for one second or longer
The set-up menu will be displayed.

2 Touch **[DISPLAY]**
The menu list will be displayed.

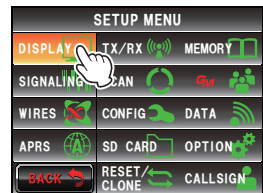

3 Touch **[2 TARGET LOCATION]** to select “COMPASS”
Each time this symbol is touched, the setting will switch between “COMPASS” and “NUMERIC”.



4 Press **[DISP]** for one second or longer
The display will return to the previous screen.

5 Press **[DISP]** briefly
The screen with the compass panel in the center will be displayed.
The direction from your station to the partner station will also be displayed using a compass needle.



Tip The compass needle will not be displayed when there is no position information.

6 Press **[DISP]** briefly
The display will return to the normal frequency display screen from the Compass screen.

Tip When the Altitude display screen and Timer/Clock screen are both “ON”, the screen will change in the following order each time **[DISP]** is pressed.
Normal frequency display → Compass/Lat&Lon display screen → Altitude display screen → Timer/Clock screen → GPS screen

Using the Smart Navigation Function

● Changing the direction of the compass panel

The compass panel can be selected from “Heading UP” where the direction of your travel is always displayed at the top, or “North UP” where north is always displayed at the top.

1 Touch the compass needle

The compass panel will switch between “Heading UP” and “North UP” each time the compass needle is touched.

The direction of the current compass panel will be indicated near the top left of the screen.



Tip

Although the scale on the compass panel has 16 directions, the compass needle can point in 32 directions.

Using the real-time navigation function

1 Switch to the Compass screen

2 Touch [YR]

During transmission in the V/D mode, the distance and direction of the received partner station is displayed.

Tip When a partner station is selected using the GM function and displayed on the compass screen, the “●” on the left hand side of the partner station call sign will blink.

When “●” is blinking, the compass display will not be updated even when signals containing position information from stations other than that displayed are received.

When [YR] is touched, “●” will light up and the compass display will be updated when signals containing position information from stations other than that displayed are received.



Using the Smart Navigation Function

When a partner station comes within 50 meters of your location, a beep will sound, the compass needle display will disappear, and the scope scale will appear in green.

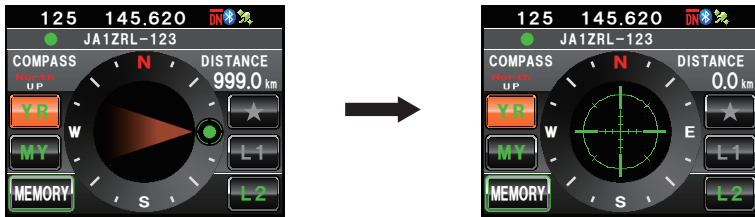

Using the backtrack function

Saving the destination

A maximum of three locations can be saved in the memory.

● Registering the current location (departure point)

- 1 Switch to the Compass screen
- 2 Touch **[MY]**
The display will turn orange in color.



- 3 Touch **[MEMORY]**

Tip This symbol is not active be touched when there is no position information.

[★], **[L1]** and **[L2]** will blink.



Using the Smart Navigation Function

4 Touch [★], [L1] or [L2]

The position information will be saved in the memory and the touched location will turn orange in color.

Tip

When position information is already registered in [★], [L1] and [L2], the text will be displayed in green color.



● Registering the locations of other stations

When position information is included in the data of other stations received through digital communications, it can be saved in the memory.

1 Switch to the Compass screen

2 Touch [YR]

The display will turn orange in color.



3 Touch [MEMORY]

[★], [L1] and [L2] will blink.

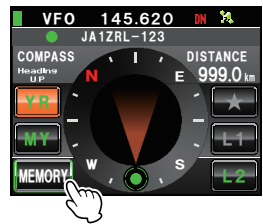

4 Touch [★], [L1] or [L2]

The position information will be saved in the memory and the touched location will turn orange in color.

Tip

When position information is already registered in [★], [L1] and [L2], the text will be displayed in green color.



Displaying the position of the destination in real time

1 Switch to the Compass screen

2 Touch [★], [L1] or [L2]

Tip This symbol is not active when position information has not been saved in the memory.

The direction of the compass needle will change following the position information that has been saved in the memory and a green circle will be displayed at the tip to show the direction of the destination.

The distance to the destination will also be displayed.

3 Move while keeping the tip of the compass needle to point towards the top

Tip When the destination registered after touching [MY] is selected, the date and time of the registration will also be displayed.



Using the APRS Function

What is the APRS Function?

There is a verity of methods to display GPS position information using amateur radios. APRS (Automatic Packet Reporting System) uses a format that is advocated by Bob Bruninga WB4APR. This system performs data communications for messages and position information.

When an APRS signal is received from a partner station, the direction, distance, speed etc. of the partner station in relation to your own station will be shown in the display of this radio.

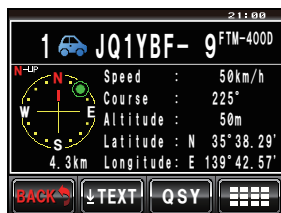

When using the APRS function, the call sign and symbol etc. of your own station need to be set (initial settings).

Refer to the separate Operating Manual APRS Edition for details (download the manual from our YAESU website).

What is the GM Function?

The GM (group monitor) function automatically checks to find if there are any stations with the GM function in operation on the same frequency within communication range. The FTM-400XDR/DE can then display the position and distance and other information on the screen.

Besides letting you know who is within your sphere of communication, this function is also convenient for instantly checking the relative positions of all the members in the group. Furthermore, this function can also be used to send data such as messages and images among the group members.



Tips

- The GM function operates only on Band A.
- The GM function does not work in the analog mode. When the GM function is activated, Band A will automatically switch to the DN mode.
- When sending image data with the GM function in operation, the mode will automatically switch to the FR mode (high speed data communication mode). At the end of the data transmission, the mode will automatically revert to the original V/D mode (simultaneous voice/data communication mode).

Basic Methods to use the GM/WIRES-X function

Refer to the separate Operating Manual GM Edition for other details on how to use the function (download the manual from our YAESU website).

● Displaying all the stations where the GM function is in operation

1 Tune the frequency in Band A

2 Press 

Up to 24 stations operating within the sphere of communication where the GM function is in operation.

- Tips**
- Stations within the sphere of communications are displayed in green.
 - Stations outside the sphere of communications are displayed in grey.

3 Press 

The GM function will be turned off and the display will return to the previous screen.

- Tip** The communications mode will automatically switch to the DN mode of the AMS.

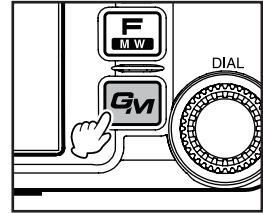

What is the WIRES-X Function?

The WIRES-X is a system that links to other users via the Internet. This function enables users to communicate with other users world wide, regardless of the distance.

When the transceiver is connected to WIRES-X, the call signs of other stations and rooms on the WIRES-X are displayed.

To establish a WIRES-X node station, the WIRES-X connection kit “HRI-200” sold separately is required. For details, refer to the separate WIRES-X Instruction Manual (download from the Yaesu website).

Communicating with Specified Partner Stations

Using the tone squelch

This radio is equipped with the CTCSS (Continuous Tone-coded Squelch System) which allows audio to be heard only when receiving signals containing the same frequency tone as the tone that has been set in the tone squelch menu. By matching the tone frequency with the partner station in advance, a quiet standby is possible.

Caution

CTCSS does not work in the digital mode. Use the  key at the beginning to switch the communication mode to the auto-mode select function (AMS), or to the analog mode.

Setting the tone frequency

The tone can be selected from 50 frequencies between 67.0 Hz and 254.1 Hz.

- 1 Press  for one second or longer
The set-up menu will be displayed.
- 2 Touch **[SIGNALING]**
The menu list will be displayed.

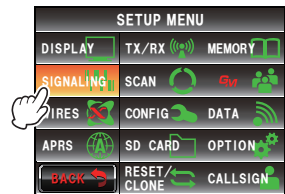

- 3 Turn  or touch the screen to select **[1 TONE SQL FREQ]**
- 4 Touch **[1 TONE SQL FREQ]**

The characters of the set value will turn orange in color.

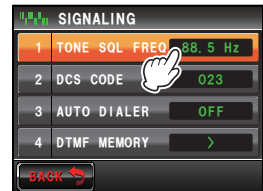

- 5 Turn  to select the frequency

Tip Factory default value: 88.5 Hz

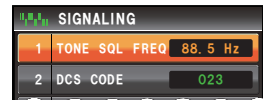

- 6 Touch **[1 TONE SQL FREQ]**
The characters of the set value will turn green in color.

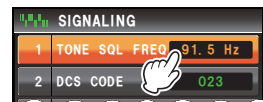

- Press **[DISP]** for one second or longer
The tone frequency will be set and the display will return to the previous screen.
Tip The display can also be returned to the previous screen by touching **[BACK]** twice.

Using the tone squelch

- Press **[F]**
The function menu will be displayed.
- Touch **[SQL]** to display “T-TRX”
Tips
 - When **[SQL]** is not displayed in the menu, use **[BACK]** or **[FWD]** to change the menu.
 - The squelch type changes in the following sequence each time it is touched.
“NOISE” “T-TX” “T-TRX” “T-REV” “D-TRX” “PRGM” “PAGER” “D-TX”* “TT/DR”* “DT/TR”*
*These squelch types will be displayed when **[SIGNALING]** → **[8 SQL EXPANSION]** is set to “ON” in the set-up menu.

The squelch will open only when receiving a tone signal of the set frequency.



Tip

A bell can be rung (beep) when signals containing the same tone code are received (P.114).

Transmitting the tone signal

- Press **[F]**
The function menu will be displayed.
- Touch **[SQL]** to display “T-TX”



Communicating with Specified Partner Stations

- 3 Press the microphone [PTT]
Radio waves including the tone signal will be transmitted while [PTT] is being pressed.



Tip

When alternating between transmit and receive repeatedly, set [SQL] in the function menu to "T-TRX".

Using digital code squelch



This radio is equipped with a DCS (Digital Coded Squelch) function that allows audio to be heard only when signals containing the same DCS code are received. By matching the DCS code with the partner station beforehand, a quiet receive standby is possible.

Caution

DCS does not work in the digital mode. Use the  key at the beginning to switch the communication mode to the auto-mode select function (AMS) or analog mode.

Setting the DCS code

The DCS code can be selected from 104 digital codes 023 to 754.

- 1 Press  for one second or longer
The set-up menu will be displayed.
- 2 Touch [SIGNALING]
The menu list will be displayed.
- 3 Turn , or touch the screen to select [2 DCS CODE]
- 4 Touch [2 DCS CODE]
The characters of the set value will turn orange in color.

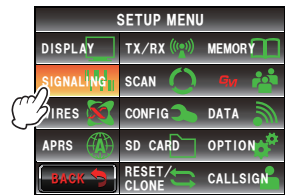

- 5 Turn **OK** to select the DSC code

Tip Factory default value: 023



- 6 Touch **[2 DCS CODE]**

The characters of the set value will turn green in color.



- 7 Press **[DMS]** for one second or longer

The DCS code will be set and the display will return to the previous screen.

Tip The display can also be returned to the previous screen by touching **[BACK]** twice.

Using DCS

- 1 Press **[F]**

The function menu will be displayed.

- 2 Touch **[SQL]** to display “D-TRX”

Tips

- When **[SQL]** is not displayed in the menu, use **[BACK]** or **[FWD]** to change the menu.
- The squelch type changes in the following sequence each time it is touched.
 “NOISE” “T-TX” “T-TRX” “T-REV” “D-TRX” “PRGM” “PAGER” “D-TX”* “TT/DR”* “DT/TR”*

*These squelch types will be displayed when

[SIGNALING] → **[8 SQL EXPANSION]** is set to “ON” in the set-up menu.

The squelch will open only when the set DCS code is received.



Tip

A bell can be rung (beep) when signals containing the same DCS code are received (P.114).

Using the pager function

Use this function to call specified stations only by using a pager code that combines two CTCSS tones.

Caution

The pager function does not work in the digital mode. Use the  key when beginning operations to switch the communications to the auto-mode select function (AMS) or analog mode.

Setting the receive station code

- 1 Press  for one second or longer
The set-up menu will be displayed.
- 2 Touch **[SIGNALING]**
The menu list will be displayed.

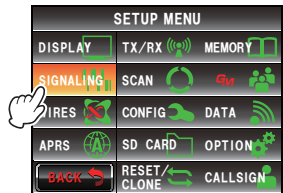

- 3 Turn , or touch the screen to select **[5 PAGER CODE]**
- 4 Touch **[5 PAGER CODE]**
The code setting screen will be displayed.



- 5 Touch **[RX CODE 1]** twice
The characters of the set value will turn orange in color.



- 6 Turn  to select the code
Select the first code from 01 to 50.
Tip Factory default value: 05

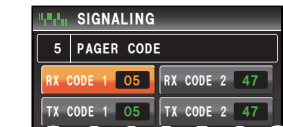

- 7 Touch **[RX CODE 1]**
The characters of the set value will turn green in color.



8 Touch **[RX CODE 2]** twice

The characters of the set value will turn orange in color.



9 Turn  to select the code

Select the second code from 01 to 50.

Tip Factory default value: 47



10 Touch **[RX CODE 2]**

The characters of the set value will turn green in color.

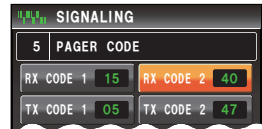

11 Press  for one second or longer

Your own station code will be set and the display will return to the previous screen.

Tip The display can also be returned to the previous screen by touching **[BACK]** twice.

Tips

- The two codes “05 47” and “47 05” will be recognized as the same code even if the order is different.
- Three or more stations with the same code can be set (group code) to call all group members at the same time.

Activating the pager function

- 1 Press 

The function menu will be displayed.

- 2 Touch **[SQL]** to display “PAGER”

Tips • When **[SQL]** is not displayed in the menu, use **[BACK]** or **[FWD]** to change the menu.

• The squelch type changes in the following sequence each time it is touched.

“NOISE” “T-TX” “T-TRX” “T-REV” “D-TRX” “PRGM”

“PAGER” “D-TX”* “TT/DR”* “DT/TR”*

*These squelch types will be displayed when

[SIGNALING] → **[8 SQL EXPANSION]** is set to “ON” in the set-up menu.



The operating band will standby to receive in the pager mode.



Recalling a specified station

- 1 Press  for one second or longer

The set-up menu will be displayed.

- 2 Touch **[SIGNALING]**

The menu list will be displayed.

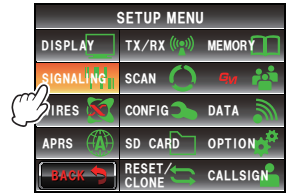

- 3 Turn , or touch the screen to select **[5 PAGER CODE]**

- 4 Touch **[5 PAGER CODE]**

The code setting screen will be displayed.



5 Touch **[TX CODE 1]** twice

The characters of the set value will turn orange in color.

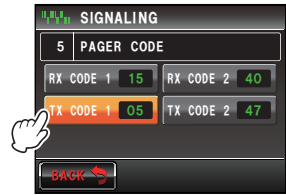

6 Turn  to select the code

Select the first code from 01 to 50.

Tip Factory default value: 05



7 Touch **[TX CODE 1]**

The characters of the set value will turn green in color.



8 Touch **[TX CODE 2]** twice

The characters of the set value will turn orange in color.



9 Turn  to select the code

Select the second code from 01 to 50.

Tip Factory default value: 47



10 Touch **[TX CODE 2]**

The characters of the set value will turn green in color.



11 Press  for one second or longer

The partner station code will be set and the display will return to the previous screen.

Tip The display can also be returned to the previous screen by touching **[BACK]** twice.

12 Activate the pager function

13 Press the microphone **[PTT]**

The partner station will be called.

Notification of an incoming call from a partner station using the bell

When communicating using the tone squelch, DCS or pager, a bell (beep) can be sounded to provide notification that a signal has been received from a partner station.

- 1 Press **[DISP/STAMP]** for one second or longer
The set-up menu will be displayed.
- 2 Touch **[SIGNALING]**
The menu list will be displayed.

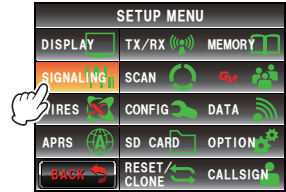

- 3 Touch **[7 BELL RINGER]** to select the length of the bell ring
The bell ring changes as follows each time it is touched.
“OFF” “1 time” “3 times” “5 times” “8 times”
“CONTINUOUS”

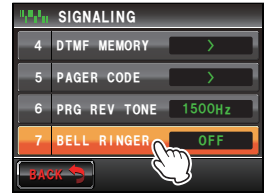

Tip Factory default value: OFF

- 4 Press **[DISP/STAMP]** for one second or longer
The bell ring will be set and the display will return to the previous screen.
Tip The display can also be returned to the previous screen by touching **[BACK]** twice.

Other squelch functions

● Reverse tone

Touch **[SQL]** in the function menu to display “T-REV”.

This is a communication method whereby a tone signal is sent out when there is no sound. When there is a sound, the tone signal will disappear.

● User Programmed Reverse CTCSS Decoder

Touch **[SQL]** in the function menu to display “PRGM”.

The user programmable Reverse CTCSS Decoder will mute your FTM-400XDR/DE receiver when it receives a signal containing a CTCSS tone matching your programmed tone. The tone signal frequency can be set at 100 Hz intervals between 300 Hz and 3000 Hz using **[SIGNALING]** → **[6 PRG REV TONE]** in the set-up menu.

● DCS transmission

Touch **[SQL]** in the function menu to display “D-TX”.

The radio sends out the DCS code during transmit.

This can be used only when **[SIGNALING]** → **[8 SQL EXPANSION]** is set to “ON” in the set-up menu.

● Tone transmission / DCS reception

Touch **[SQL]** in the function menu to display “TT/DR”.

The radio sends out a tone signal during transmit and goes into receive standby for the previously set DCS codes.

This can be used only when **[SIGNALING]** → **[8 SQL EXPANSION]** is set to “ON” in the set-up menu.

● DCS transmission / tone reception

Touch **[SQL]** in the function menu to display “DT/TR”.

The radio sends out the DCS code during transmit and goes into receive standby for the previously set squelch tone.

This can be used only when **[SIGNALING]** → **[8 SQL EXPANSION]** is set to “ON” in the set-up menu.

Using the DTMF Function

The DTMF (Dual Tone Multi Frequencies) is a “peepoppa” sound heard from a telephone receiver when a call is made on a push phone line. This radio can send out the DTMF code by using the microphone keys or recalling a memory.

A DTMF code with a maximum of 16 digits can be registered in up to 9 channels in the memory. It is convenient to register beforehand telephone numbers that are used for connecting to a public line from a phone patch.

Tip

The DTMF code is issued based on a combination of the following frequencies.

	1209 Hz	1336 Hz	1477 Hz	1633 Hz
697 Hz	1	2	3	A
770 Hz	4	5	6	B
852 Hz	7	8	9	C
941 Hz	*	0	#	D

Registering the DTMF code

- 1 Press **[DISP]** for one second or longer
The set-up menu will be displayed.
- 2 Touch **[SIGNALING]**
The menu list will be displayed.

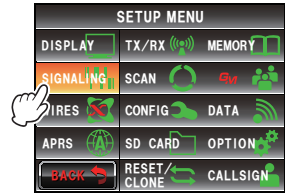

- 3 Turn **[DUAL]**, or touch the screen to select **[4 DTMF MEMORY]**
- 4 Touch **[4 DTMF MEMORY]**
The DTMF memory screen will be displayed.

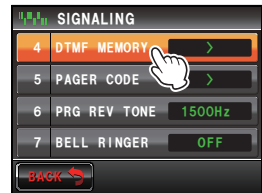

- 5 Turn **[DUAL]** or touch the screen to select the channel to be registered
- 6 Touch the selected channel
The character input screen will be displayed.

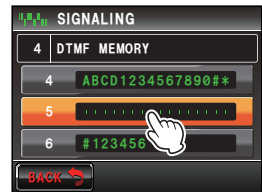

- Touch the character keys to input the DTMF code

Tip The DTMF code can also be input using the character keys on the microphone.

- Touch **[ENT]**

The DTMF code will be set.

Tip Repeat Steps 5 to 8 when registering additional numbers in the other channels..

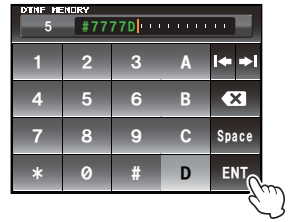

- Press **[DISP/STAND]** for one second or longer

The DTMF code will be set and the display will return to the previous screen.

Tip The display can also be returned to the previous screen by touching **[BACK]** twice.

Transmitting the registered DTMF code

- Press **[DISP/STAND]** for one second or longer

The set-up menu will be displayed.

- Touch **[SIGNALING]**

The menu list will be displayed.

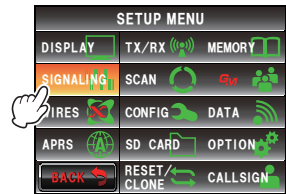

- Turn **[DATA]**, or touch the screen to select **[3 AUTO DIALER]**

- Touch **[3 AUTO DIALER]** to select “ON”

The auto dialer will switch between “ON” and “OFF” each time it is touched.

- Press **[DISP/STAND]** for one second or longer

The display will return to the previous screen.

Tip The display can also be returned to the previous screen by touching **[BACK]** twice.



- Press **[F/VIEW]**

The function menu will be displayed.

- Touch **[DTMF]**

The character will turn orange in color.

Tip When **[DTMF]** is not displayed in the menu, use **[BACK]** or **[FWD]** to switch the menu.



Using the DTMF Function

- Turn  to select the DTMF code
- Press the microphone **[PTT]**
The DTMF code will be sent out automatically.



- Release the microphone **[PTT]**
The transmission will continue until the DTMF signal is sent out.

Sending out the DTMF code manually

- Press and hold down the microphone **[PTT]** and press **[0]** to **[9]**, **[*]**, **[#]**, **[A]** to **[D]**
- Release the microphone **[PTT]**
The transmission will continue until the DTMF signal is sent out.

Using the Timer Function

Using the stopwatch function

This radio is equipped with a lap timer and countdown timer. These can be used by switching to the timer / clock screen.

Displaying the timer / clock screen

1 Press **[DISP/STAND]** for one second or longer
The set-up menu will be displayed.

2 Touch **[DISPLAY]**
The menu list will be displayed.

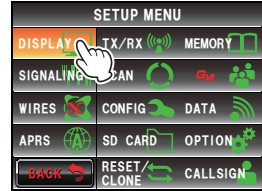

3 Turn **[RADIO]**, or touch the screen to select **[1 DISPLAY SELECT]**

4 Touch **[1 DISPLAY SELECT]**
The screen for setting the various screens on or off will be displayed.



5 Touch **[TIMER/CLOCK]** to select "ON"
Each time this is touched, the setting will switch between "OFF" and "ON".

6 Press **[DISP/STAND]** for one second or longer
The display will return to the previous screen.

Tip The display can also be returned to the previous screen by touching **[BACK]** twice.



7 Press **[DISP/STAND]** twice briefly
The timer/clock screen will be displayed.

Tip The screen will change in the following sequence each time **[DISP/STAND]** is pressed when both the altitude display screen and GPS screen are "ON".

Normal frequency display → Compass/Lat&Lon display screen → Altitude display screen → Timer/Clock screen → GPS screen



Using the lap timer

- 1 Display the timer / clock screen
- 2 Touch **[MODE]**
The lap timer will be displayed.



- 3 Touch **[START]**
The timer will start.



- 4 Touch **[LAP]**
The lap time will be saved in the memory each time it is touched.
Tip Up to 99 lap times can be saved in the memory.



- 5 Touch **[STOP]**
The timer will stop.



The lap times and split times will be erased when **[RESET]** is touched.



The lap time measured in the past will be displayed when **[RECALL]** is touched. When there are multiple lap times, touch **[▲]** or **[▼]** to switch between the lap times.

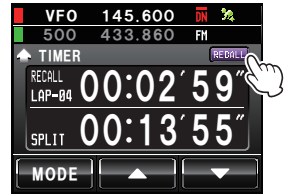

6 Touch **[DISP DISP]** briefly twice

The display will return to the previous screen.

Tips • Touch **[RECALL]** when the previous lap times are being displayed and then turn **[DISP DISP]** twice.

- The screen will change in the following sequence each time **[DISP DISP]** is pressed when both the altitude display screen and GPS screen are "ON".

Normal frequency display → Compass/Lat&Lon display screen → Altitude display screen → Timer/Clock screen → GPS screen

Using the countdown timer

1 Display the timer / clock screen

2 Touch **[MODE]** twice

The countdown timer will be displayed.



3 Touch **[SETUP]**

The "Hour" of the start time will blink.

4 Turn **[DIAL A]** to set the hour

- Tips**
- The hour can be set between 00 and 99.
 - The time can also be set by touching **[+]** or **[-]**.



5 Touch **[SETUP]**

The "Hour" will be set, and "Minute" will blink.

6 Turn **[DIAL A]** to set the minute

Tip The time can also be set by touching **[+]** or **[-]**.



Using the Timer Function

7 Touch [SETUP]

The “Minute” will be set and the set time will be displayed in the counter.



8 Touch [START]

The countdown timer will start.



When the set time has passed, a beep will sound and the time will be displayed as “00:00’00” in green characters.

Touch [STOP] to pause the timer in between.

Touch [START] to restart the countdown and touch [RESET] to measure from the start again.



9 Press briefly twice

The display will return to the previous screen.

Tip The screen will change in the following sequence each time  is pressed when both the altitude display screen and GPS screen are “ON”.

Normal frequency display → Compass/Lat&Lon display screen → Altitude display screen → Timer/Clock screen → GPS screen

Using the APO function

When the APO (Automatic Power-off) function is set to ON, the power supply to the radio will be automatically switched off when there has been no operation for a preset period of time. A notification beep will sound one minute before the power is turned off. This helps to prevent the battery from being used up when you forget to switch the radio off when connected to a car battery.

- 1 Press  for one second or longer
The set-up menu will be displayed.
- 2 Touch **[CONFIG]**
The menu list will be displayed.

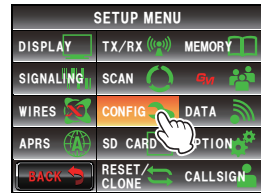

- 3 Turn , or touch the screen to select **[13 APO]**
- 4 Touch **[13 APO]**

The screen for selecting “ON”, “OFF” and the time until the power is turned off after operations will be displayed.

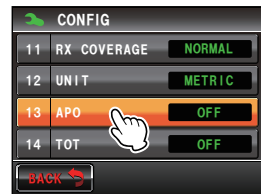

- 5 Touch **[ON]**
- 6 Touch **[+]** or **[-]** to select the time until the power supply is switched off
The time will change by one step each time it is touched. The time step can be selected from the following 14 steps.

“0.5hour” “1.0hour” “1.5hour” “2.0hour” “3.0hour”
“4.0hour” “5.0hour” “6.0hour” “7.0hour” “8.0hour”
“9.0hour” “10.0hour” “11.0hour” “12.0hour”

- 7 Press  twice briefly
The APO function will be switched on and the display will return to the previous screen.

Tip The display can also be returned to the previous screen by touching **[BACK]** twice.

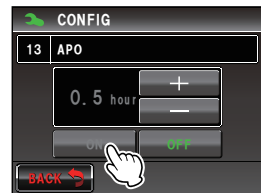

Using the TOT function

When the TOT (Timeout Timer) function is switched on, the radio will automatically return to the reception mode after a prescribed time has passed in the transmission mode. A notification beep will sound about 10 seconds before the radio returns to the reception mode*. This can help to prevent unintended radio waves from being sent out by mistake and the battery from being used up.

* Beep sound does not function in the digital mode.

1 Press  for one second or longer
The set-up menu will be displayed.

2 Touch **[CONFIG]**
The menu list will be displayed.

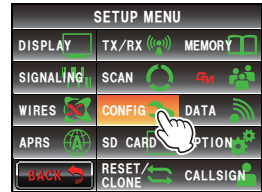

3 Turn , or touch the screen to select **[14 TOT]**

4 Touch **[14 TOT]**
The characters of the set value will turn orange in color.

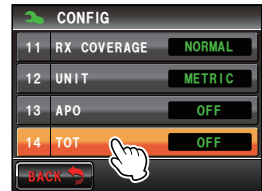

5 Turn  to select the time
The time will change in the following sequence.
“OFF” “1 min” “3 min” “5 min” “10 min” “15 min”
“20 min” “30 min”



6 Touch **[14 TOT]**
The characters of the set value will turn green in color.



7 Press  twice briefly
The TOT function will be switched on and the display will return to the previous screen.

Tip The display can also be returned to the previous screen by touching **[BACK]** twice.

Changing the Touch Key Function

Frequently used functions in the function menu can be assigned to the touch keys at the bottom of the screen.

Example: Changing [MUTE] to [SCAN]

- 1 Touch **[MUTE]** for 4 or more seconds
A list of the function keys will be displayed.

Tip The list of function keys can be scrolled by turning .

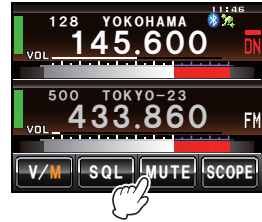

- 2 Touch **[SCAN]**
The touch key **[MUTE]** will change to **[SCAN]**.



- 3 Touch the touch key **[SCAN]**
The display will return to the previous screen.

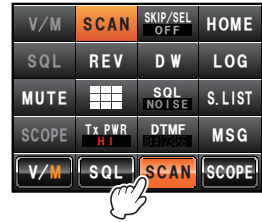

[MUTE] will become operable in the function menu displayed when  is pressed.



Tip

The assignment of functions to the other touch keys can also be changed using Step 2. After the touch key display is changed, touch another touch key first before touching the function key. To return to the previous screen, touch the key whose assignment was changed last (displayed in orange color).

Sending and Receiving Messages and Pictures

When operating in the digital mode, messages (text) and pictures can be sent and received.

Messages and pictures sent or received will be saved in the common list in the memory.

Cautions

- When sending or receiving messages and pictures, use the  key before beginning to switch the communications to the AMS (auto mode select function) or the digital mode.
- The operation of the radio will automatically switch to the digital mode on Band A when sending messages and pictures.
- When the list of the data is displayed by touching **[LOG]** while operating on Band B, the operating band will switch to Band A when returning to the frequency display screen.
- Set up the micro-SD card in the radio when downloading pictures. Refer to "Setting Up the micro-SD card" (P.33) for details.

Tip

The following are the three types of digital modes available. Refer to "Switching the communication mode" (Page 45) for details.

- V/D mode (simultaneous voice / data communication mode)
- Voice FR mode (voice full-rate mode)
- Data FR mode (high speed data communication mode)

Viewing messages and pictures

The data sent or received can be viewed in the list. The contents of the data sent or received can be verified by selecting it from the list.

1 Press .

The function menu will be displayed.



2 Touch **[LOG]**

Tip When **[LOG]** is not displayed in the function menu, touch **[BACK]** or **[FWD]** to switch the menu.

The list of data will be displayed.



3 Turn  or touch the screen to select the data that you want to check

- Tips**
- A list of the messages is displayed when the touch key is . This will be changed to a list of pictures when the screen is touched and changed to .
 - Newly downloaded data will appear at the top of the list.
 - Touch  to display the end of the list.
 - Touch **[TOP]** to display the top of the list.



4 Touch the selected data

The contents of the data will be displayed.

- Tip**
- A picture with a resolution of 320 * 240 pixels will be displayed in full screen when touched. After 10 seconds or when the picture is touched again, it will return to the original display.
 - Touch **[EDIT]** at the top right of the picture to edit the tag (image name).



Tip

Pictures taken using the optional camera attached to the speaker microphone MH-85A11U and saved in the micro-SD card will also be displayed in the list.

Sorting the messages and pictures

Data that is no longer needed can be deleted from the memory and micro-SD card.

● Deleting data using the content display screen

1 Display the data content that you would like to delete

2 Touch **[DEL]**

A screen to confirm whether or not to delete the data will be displayed.



3 Touch **[OK?]**

The deletion will start.

When the deletion is completed, the screen will return to the list of data.

The list of data will move up one at a time.

- Tip** Touch **[CANCEL]** to stop the deletion.



Sending and Receiving Messages and Pictures

● Erasing from the list

1 Turn  or touch the screen to select the data that you want to delete

2 Touch **[DEL]**

A screen to confirm whether or not to delete the data will be displayed.



3 Touch **[OK?]**

The deletion will start.

When the deletion is completed, the screen will return to the list of data.

The list of data will move up one at a time.

Tip Touch **[CANCEL]** to stop the deletion.



Downloading messages and images

When messages or pictures are sent in the digital mode at the frequency currently in operation, the contents will be displayed for a certain period of time. Messages will also be downloaded to the memory of this radio or the micro-SD card set up in the radio.

When receiving messages

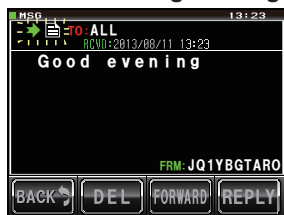

When receiving pictures



Tips

- When receiving picture data, the call sign of the sender and an estimation of the time remaining for the data reception to be completed will be displayed after ">".
- The message "Not Completed" will be displayed if downloading of the message is unsuccessful because the format is not supported or for other reasons.
- The message "Insufficient SD's Memory" will be displayed when the picture cannot be downloaded due to insufficient memory space in the micro-SD card.

Sending messages and pictures

Messages and pictures can be sent from this radio when operating in the digital mode. Data sent will be received by all stations operating at the same frequency in the digital mode.

The following are the four types of data transmission methods.

- (1) Create and send a new message
- (2) Send a saved picture
- (3) Replies to a downloaded message or picture
- (4) Forwards the downloaded message or picture

Creating and sending a message

- 1 Press **F**

The function menu will be displayed.

- 2 Touch **[LOG]**

Tip When **[LOG]** is not displayed in the function menu, touch **[BACK]** or **[FWD]** to switch the menu.

The list of data will be displayed.



- 3 Turn **DATA** or touch the screen to select **[NEW]**

- 4 Touch **[NEW]**

A screen to confirm the message contents will be displayed.



- 5 Touch **[]**

The character input screen will be displayed.



- 6 Touch the character keys to input the message

The touched characters will be displayed at the top of the screen.

Tips

- Up to 80 characters can be entered.
- Alphabet, numeric and symbol characters can be entered.



Sending and Receiving Messages and Pictures

7 Touch [ENT]

The entered characters will be set and the display will return to the screen for confirming the message contents.

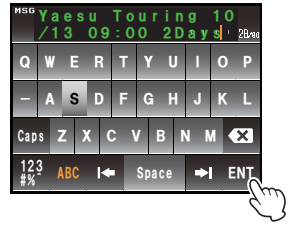

8 Touch [SEND]

Message transmission will start and the icon on the left side of the address will blink. The sending and receiving indicator at the top left of the screen will also change to red.

“Completed” will be displayed when the message is completed. The display will then return to the message list screen. The tag of the sent message will be added to the top of the list.

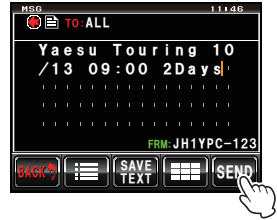

● Using standard message

The following 19 standard text messages have been entered in the radio previously, to save on time and effort for inputting the text.

1	QRM	11	Good night
2	QRP	12	Send messages
3	QRT	13	Send pictures
4	QRX	14	on my way
5	QRZ	15	wait for you
6	QSY	16	Pick me up
7	Good morning	17	Thank you
8	Good job	18	OK
9	Good day	19	urgent
10	Good evening		

1 Follow Steps 1 to 4 on “Creating and sending messages” (P.129) to display the screen for creating new message contents.

2 Touch [☰]

The standard message field will be displayed under the message.

Tip A maximum of 80 characters can be registered in “01:” to “10:” (P.132).

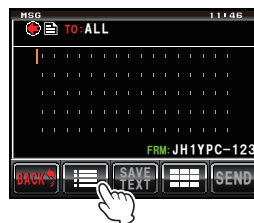

3 Turn **CALL** to display the standard message that you want to use

4 Press **CALL**

The standard message will be displayed as the message text.

Tip The message text can also be displayed by touching the standard message displayed.



Sending and Receiving Messages and Pictures

5 Touch [≡]

The standard message field under the message will disappear.

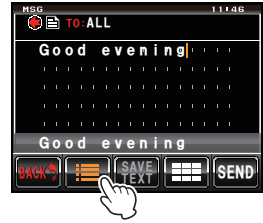

6 Follow Steps 5 to 7 in “Creating and sending a messages” (P.129) to enter the text when adding text.

● Registering standard messages

Up to 10 texts containing a maximum of 80 characters each can be registered as standard messages.

Registered text can be selected and used just like the 19 standard text messages that have been prepared beforehand.

1 Follow Steps 1 to 7 on “Creating and sending a messages” (P.129) to display the screen for confirming the message contents.

Tip Alphabet, numeric and symbol characters can be entered.

2 Touch [SAVE TEXT]

The standard message field will be displayed under the message.

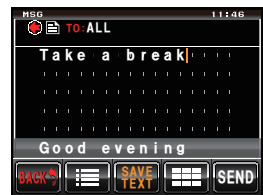

3 Turn [DATA] to display the number that you want to register

Tip Either one of “01” to “10” is selectable.

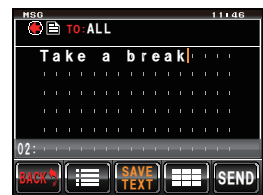

4 Press

The text will be saved as a standard text, and the standard message field will disappear.

- Tip**
- Text can also be registered by touching the registration number displayed.
 - When registering a text message under a number that already contains a standard message, the previous standard message will be overwritten.
 - Touch **[SAVE TEXT]** when canceling the registration.



Sending saved pictures

Pictures taken using the optional camera attached to the speaker microphone MH-85A11U can be sent.

Tip

Refer to “Taking pictures with the optional camera attached to the speaker microphone” (P.144) on how to take pictures with the optional camera attached to the speaker microphone MH-85A11U.

1 Press

The function menu will be displayed.



2 Touch **[LOG]**

- Tip** When **[LOG]** is not displayed in the function menu, touch **[BACK]** or **[FWD]** to switch the menu.

The list of data will be displayed.



3 Turn or touch the screen to select the picture that you want to send

- Tip**
- A list of the messages is displayed when the touch key is . This will be changed to a list of pictures when the screen is touched and changed to .
 - Pictures with an  icon displayed to the left of the tag have been taken with the camera attached to the speaker microphone.

4 Touch the selected picture

The details and image will be displayed.



5 Touch **[FORWARD]**

Transmission of the picture will start and the icon on the left side of the address will blink. The sending and receiving indicator at the top left of the screen will also change to red.

“Completed” will be displayed when sending of the picture is completed and the display will then return to the picture list screen. The tag of the transmitted picture will be added to the top of the list.



Tips

- Transmission of a picture will be stopped when **[PTT]** of the microphone is pressed during transmission (it may take a certain period of time until the transmission stops).
- When sending a picture, the communication mode will automatically switch to the VV mode (high speed data communication mode). At the end of the transmission, the mode will automatically revert to the DN mode of the AMS.

Replying to a message or picture

Return messages can be sent in reply to messages and pictures received.

1 Press **[F]**

The function menu will be displayed.

2 Touch **[LOG]**

Tip When **[LOG]** is not displayed in the function menu, touch **[BACK]** or **[FWD]** to switch the menu.

The list of data will be displayed.



3 Turn **[A]**, or touch the screen to select the message or picture that you want to reply

Tip A list of the messages is displayed when the touch key is **[A]**. This will be changed to a list of pictures when the screen is touched and changed to **[A]**.

- 4 Touch the selected message or picture
The contents of the data will be displayed.



- 5 Touch **[REPLY]**
The reply message screen will be displayed.
The call sign of the calling station will be displayed in the address.

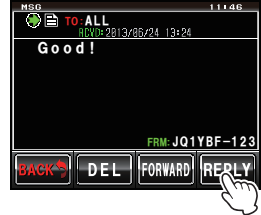

The first 16 characters of the message received will be automatically inserted after "Re:".

Tip When replying to a picture, the first 16 characters of the tag (display name) will be inserted after "Re:".

- 5 Touch **[≡]**
The character input screen will be displayed.

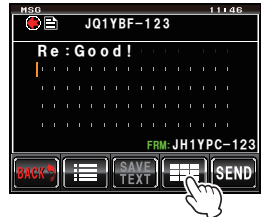

- 6 Touch a character key to input the message
The touched character will be displayed at the top of the screen.

Tip The first 16 characters can also be edited.



- 7 Touch **[ENT]**
The entered characters will be set and the display will return to the reply message screen.

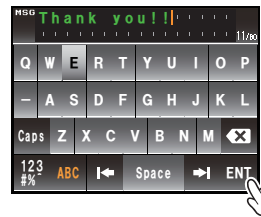

8 Touch [SEND]

Message transmission will start and the icon on the left side of the address will blink. The sending and receiving indicator at the top left of the screen will also change to red.

“Completed” will be displayed when sending of the message is completed and the display will then return to the message list screen. The tag of the sent message will be added to the top of the list.



Forwarding messages and pictures

Downloaded messages and pictures can be forwarded.

1 Press [F.MENU]

The function menu will be displayed.

2 Touch [LOG]

Tip When [LOG] is not displayed in the function menu, touch [BACK] or [FWD] to switch the menu.

The list of data will be displayed.



3 Turn [A], or touch the screen to select the message or picture that you want to forward

Tip A list of the messages is displayed when the touch key is [list icon]. This will change to a list of pictures when the screen is touched and changed to [picture icon].

4 Touch the selected message or picture

The contents of the data will be displayed.



5 Touch [FORWARD]

Transmission of the data will start and the icon on the left side of the address will blink. The sending and receiving indicator at the top left of the screen will also change to red.

“Completed” will be displayed when sending of the data is completed and the display will then return to the data list screen. The tag of the transmitted data will be added to the top of the list.

- Tips**
- When forwarding a message, touch **[OK?]** when the screen for confirming the address appears before the message is sent.
 - Pictures can be forwarded by pressing the **[D-TX]** of the speaker microphone with camera.



Tips

- Transmission of a picture will be stopped when **[PTT]** of the microphone is pressed during transmission (it may take a certain period of time until the transmission stops).
- When sending a picture, the communication mode will automatically switch to the VW mode (high speed data communication mode). At the end of the transmission, the mode will automatically revert to the DN mode of the AMS.

Using the Bluetooth Headset

The optional Bluetooth unit “BU-2” and headset BH-2A are available for wireless headset operation.

Hands-free communication is also possible when the VOX (Voice Operated Xmit) function is used.

Tip

Other Bluetooth headsets can also be used but not all the functions are guaranteed to work normally.

Mounting the Bluetooth unit “BU-2”

● Tools and parts needed

- Bluetooth unit “BU-2” (optional)
- Phillips screw driver #1

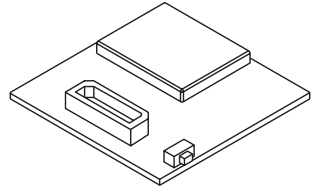

● Mounting procedure

Cautions

- Avoid touching the IC components with your hands as the semiconductors may be damaged by static electricity.
- Note that labor charges to install optional items may be separately charged.

- 1 Switch the radio OFF
- 2 Switch off the external power supply
- 3 Unplug the control cable, microphone and DC power supply cable from the main body
- 4 Remove the eight screws from the main body, four on top and two each at the sides

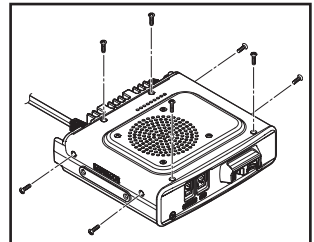

- 5** Carefully lift up the front side of the main body top cover

Caution Do not lift up the top cover quickly by force. This may damage the damage cables between the speaker and main board.

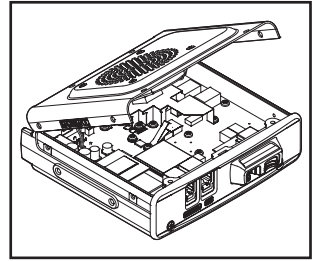

- 6** Unplug the speaker cables extending from the top cover to the connector on the board inside the main body first before removing the cover

Caution Hold the connector when unplugging the cable avoid pulling the cable itself.

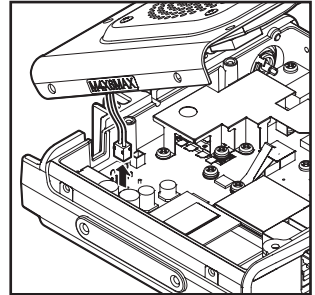

- 7** Remove the two screws in the front of the main body
8 Lift the front hook in the center at the top first before removing the front cover

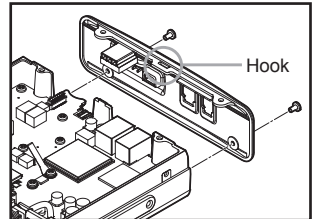

- 9** Refer to the figure on the right to mount the BU-2
Caution Check the direction of the connector and plug the BU-2 in all the way to the back.

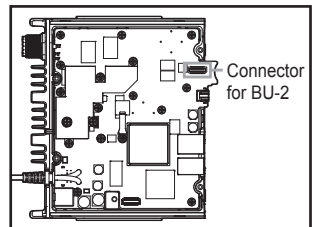

- 10** Attach the main body front cover and secure using the two screws
11 Plug in the speaker cables extending from the main body top cover to the original socket on the board
12 Attach the main body top cover and replace all eight screws

Setting the Bluetooth headset operation

Set the Bluetooth parameters for your preferences in accordance with the following wireless headset operating methods:

- Listening to the audio using the headset only, or allowing the audio to be heard from both the headset and the radio speaker
- Conserving the headset battery power
- Using the [PTT] to switch between transmitting and receiving, or switching automatically using voice
- Switching transmit and receive automatically even with low level sounds

- 1 Turn the FTM-400XDR/DE on
- 2 Press **[DNDP]** for one second or longer
The set-up menu will be displayed.
- 3 Touch **[OPTION]**

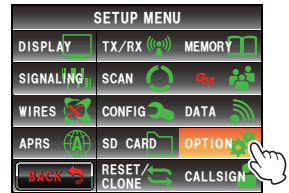

- 4 Select and touch **[2 Bluetooth]**

Tip This symbol is not available when BU-2 is not mounted to the radio.

The screen for the settings will be displayed.

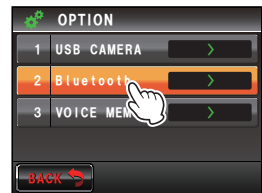

- 5 Touch **[AUDIO]**

The setting switches between “AUTO” and “FIX” each time it is touched.

“AUTO”: When a Bluetooth headset is connected, the sound from the radio speaker will be muted and sound will only be heard from the headset.

“FIX”: Sound can be heard from both the Bluetooth headset and the radio speaker.

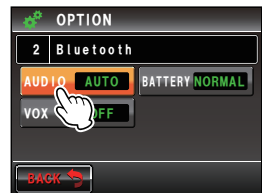

- 6 Touch **[BATTERY]**

The setting will switch between “NORMAL” and “SAVE” each time it is touched.

“NORMAL”: The Bluetooth headset battery save function will be switched off.

“SAVE”: The Bluetooth headset battery save function will be switched on.

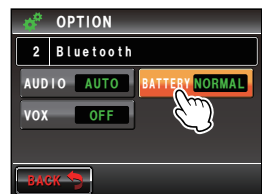

7 Touch [VOX]

The setting will switch between “OFF” and “ON” each time it is touched.

“OFF”: Switch the transmission and reception using [PTT].

“ON”: Switch the transmission and reception using voice.

Tip When VOX is set to ON, [GAIN] is displayed.

8 Touch [GAIN]

The setting switches between “HIGH” and “LOW” each time it is touched.

“HIGH”: The Bluetooth headset VOX sensitivity will become higher and more responsive to low level.

“LOW”: The Bluetooth headset’s VOX sensitivity will become lower and less responsive to low sounds.

9 Press  for one second or longer

The Bluetooth headset operation will be set and the display will return to the previous screen.

Tip Factory default value: AUDIO: AUTO
BATTERY: NORMAL
VOX: OFF
GAIN: HIGH

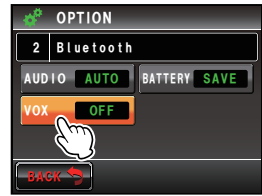
**Identifying the Bluetooth headset**

An individual identification code known as a “PIN code” is assigned to Bluetooth devices such as a headset. The PIN code allows mutual identification with paired devices to be carried out and recorded when initially when using a Bluetooth terminal device. This is known as “pairing”. Through pairing, interference and improper interception can be prevented.

Pairing is also carried out initially when communicating wirelessly with this radio using a Bluetooth headset.

Tip

The PIN code for the Yaesu Bluetooth headset “BH-2A” is 6111. Check the PIN code in the operating manual of the product when using Bluetooth headsets from other companies.

Example: When pairing the optional Bluetooth headset “BH-2A”

Tip

Refer to the operating manual of the product used for the pairing method when using a headset other than BH-2A.

- 1 Turn the BH-2A headset OFF
- 2 Press **[DISP/SEND]** for one second or longer
The set-up menu will be displayed.
- 3 Touch **[CONFIG]**
The menu list screen will be displayed.

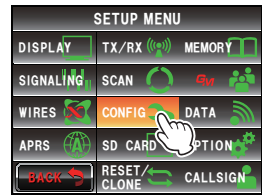

- 4 Select and touch **[15 Bluetooth PAIRING]**
The input screen for the PIN code will be displayed.

- Tips**
- “6111” will be displayed in the PIN code field as the factory default value.
 - When using a headset other than BH-2A, enter the 4-digit PIN code of the headset here. The character at the cursor position will be overwritten when the number key on the screen is touched.



- 5 Press the power supply switch of the BH-2A for 5 seconds
The LED indicator of the BH-2A will blink alternately between red and blue.



- 6 Touch **[ENT]**
The display will return to the menu list screen and the text “Pairing..” will blink in the display field of the set value.

“Completed” will be displayed when pairing is successful and the screen will then return to the menu list.

The LED indicator of the BH-2A will also blink in blue.

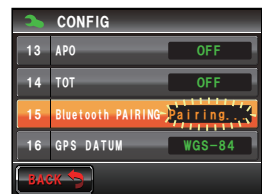
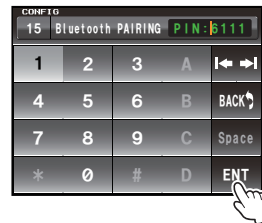
Caution Start pairing all over again when “ERROR” is displayed.



- 7 Press  for one second or longer
The display will return to the previous screen.
The “” icon will be displayed on the top right of the band display area.

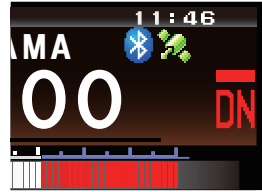

Tips

- Up to 8 pairing PIN codes can be saved in BU-2. When using two or more headsets such as a spare one or a personal one, set up the respective PIN codes and carry out pairing in advance. However, two headsets cannot be used at the same time.
- When eight pairings have been carried out after eight PIN codes have already been made, the oldest pairing information will be overwritten.

Using the Bluetooth headset

Once paired, a headset can be used simply by turning on the power.

Tips

- The communication distance of the headset with the radio is about 10 m or less.
- The “” icon will not be displayed when the headset is too far from the radio and lies outside the sphere of communication.

(1) When the VOX function is set to OFF

- 1 Turn the Bluetooth headset ON
The receive audio will become audible from the headset.
- 2 Press the headset [PTT]
The radio will go into the transmit mode.
- 3 Release the headset [PTT]
The radio will go into the receive mode.

(2) When the VOX function set to on

- 1 Turn the Bluetooth headset ON
The receive audio will become audible from the headset.
- 2 Speak into the microphone of the headset
The radio will go into the transmit mode.
Tip When you stop talking, the radio will automatically return to the receive mode.

Taking Pictures with the optional Camera (Snapshot Function)

Snapshots can be easily taken with the camera that is built into the optional speaker microphone “MH-85A11U”.

The picture taken will appear on the display for several seconds and can also be transmitted to other transceivers simply by pressing the transmit picture button on the microphone.

Tips

- Refer to our YAESU website and catalog for the transceiver models that can transmit pictures.
- The picture transmit button on the microphone can only transmit picture data after the image has been taken.
- The snapshot function will not operate unless the micro-SD card is inserted into the card slot on the main body.

The picture taken will be saved in the micro-SD card inserted into the main body card slot. The saved picture data can be transmitted to transceivers operating in the digital mode.

Connecting the speaker microphone with camera

- 1 Switch the power supply to the radio OFF
- 2 Connect the MH-85A11U to the main body

Refer to the figure on the right to plug the connector of the microphone into the [DATA] jack at the front of the main body.

Caution Check the direction of the connector and plug it in all the way.

- 3 Referring to the figure, mount the provided microphone cord holder to secure the MH-85A11U cord to the main body.

Caution Remove the screws at the side of the radio and use the provided screw and washer to mount the microphone cord holder.

Tip As the microphone connector can be passed through the microphone cord holder attached to the radio, there is no need to remove it once it is mounted.

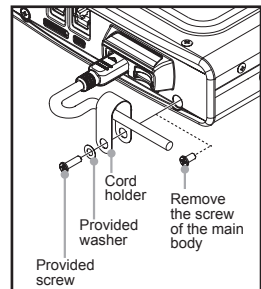
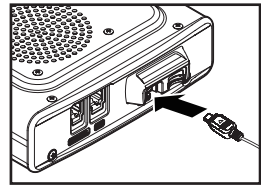

- 4 Switch on the power supply to the main device
- 5 Press **[DISP]** for one second or longer
The set-up menu will be displayed.
- 6 Touch **[DATA]**

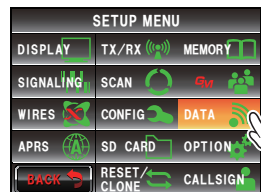

7 Touch [1 COM PORT SETTING]

The screen for the detailed settings will be displayed.

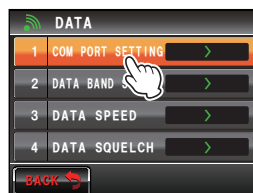

8 Touch [OUTPUT] to select "OFF(camera)"

The setting changes as follows each time it is touched.

"OFF(camera)" → "GPS OUT" → "PACKET" → "WAYPOINT"

Tip Factory default value: OFF (camera)

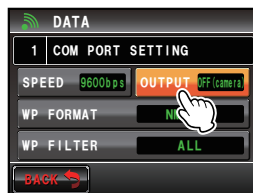

9 Press [DISP/SEND] for one second or longer

The display will return to the previous screen.

Tip The display can also be returned to the previous screen by touching [BACK] twice.

Taking pictures

1 Insert the micro-SD card and turn the radio ON

2 Point the camera lens at the object to be photographed and press the shutter button on the microphone

Caution Keep a focal distance of at least 50 cm between the object and the camera. The picture will be out of focus when the object is too near and the image will not be clear.

Tip In factory default, pictures will be taken with a size of 320 * 240 in the NORMAL picture quality.

The size (resolution) and quality (compression ratio) of the picture can be set using "OPTION" → "1 USB CAMERA" in the set-up menu (P.203).

The picture taken will appear in the display for 10 seconds.

Subsequently, the picture will be stored in JPEG format, on the microSD card that has been inserted into the main body card slot.

While the picture appears in the display, touch [BACK], [DEL] or [FORWARD], you can save the data, delete or transfer it to other stations.

[BACK]: Save the picture to the microSD card, then return to the original screen.

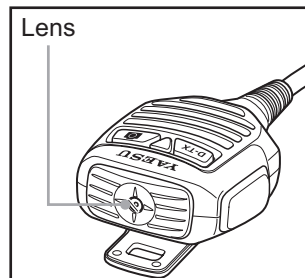
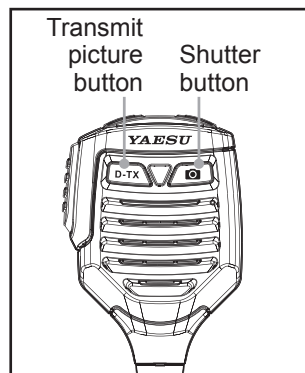

Taking Pictures with the optional Camera (Snapshot Function)

[DEL]: Delete the picture*, then return to the original screen.*:Deleted images, can be seen on the PC.

[FORWARD]: Send the picture to other transceivers.Press the microphone [PTT] button to cancel the picture transmission (the picture will be stored in the microSD card).

While the picture appears in the display, press the shutter button again, the picture will be saved to the microSD card, then the picture taken will appear in the display.

- Tip**
- It takes about 30 seconds to transmit a picture taken with a resolution of 320 * 240 to another transceiver.
 - Press the microphone **[PTT]** button to cancel the picture transmission (it may take a while for the transmission to be canceled).
 - After the picture is transmitted, the mode will automatically switch to DN of the AMS mode.

Tip

The first picture taken will be saved under the filename "M*****000001.jpg" while the pictures taken subsequently will be saved under the filenames "M*****000002.jpg", "M*****000003.jpg" and so on in increasing order.

The folder configuration in the micro-SD card is as follows and the data of the pictures taken is saved in the folder named "PHOTO" under the root directory.

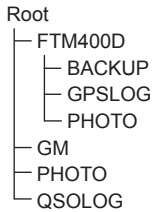

Viewing a saved picture

1 Press **[F.MENU]**

The function menu will be displayed.

2 Touch **[LOG]**

A list of the text messages or the pictures saved in the micro-SD card will be displayed.

- Tip**
- A list of the text messages will be displayed when the touch key is **[MSG]**. This will change to a list of pictures when **[PICT]** is touched.
 - The date and time the picture was taken will be used as the tag of the picture.
 - Newly taken pictures will be displayed at the top of the list.



3 Select and touch the picture that you want to see

The picture will appear after the message “Waiting...” is shown.

- Tip**
- Pictures taken with the resolution set to “320 * 240” (unit: pixel) in the set-up menu under “OPTION” → “1 USB CAMERA” → “PICTURE SIZE” will be displayed in full screen when touched. After 10 seconds or when the picture is touched again, it will return to the original screen.
 - Touch **[EDIT]** at the top right of the screen to edit the tag.
 - Touch **[DEL]** to erase the picture from the micro-SD card.
 - Touch **[FORWARD]** or **[REPLY]** to send the picture to other transceivers (see P.133).



4 Touch **[BACK]**

The display will return to the screen showing the list of pictures.



Tip

The pictures can be viewed on a personal computer by reading the contents of the micro-SD card into the personal computer.

Caution

When the filename of the picture is changed on the personal computer, the picture can not longer be shown in the display of the FTM-400XDR/DE.

Optional receive Audio Record and Playback

The receive audio received can be recorded and then played back later using the optional voice guide unit “FVS-2”.

The voice announcing the frequency of the operating band can also be heard when the announce function is set to on.

Mounting the voice guide unit “FVS-2”

● Preparations

- Voice guide unit “FVS-2” (optional)
- Plus driver

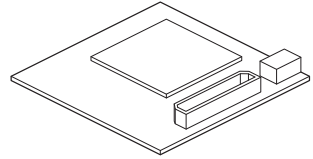

● Mounting procedure

Cautions

- Unless necessary, do not touch any parts with your hands as the semiconductors may be damaged by static electricity.
- Note that labor charges to install optional items by our company's customer service support staff shall be separately chargeable.

- 1 Switch off the power supply to the radio
- 2 Switch off the external power supply
- 3 Unplug the control cable, microphone and DC power supply cable from the main body
- 4 Remove the eight screws from the main body, four on top and two each at the sides

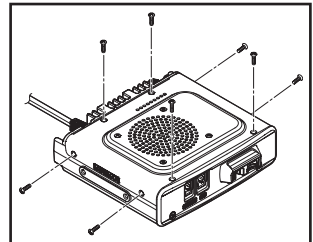

- 5 Slowly lift up the front side of the top cover of the main body

Caution Do not lift up the top cover by force. This may result in cables connected to the boards inside the main body and the speaker inside the cover to be cut.

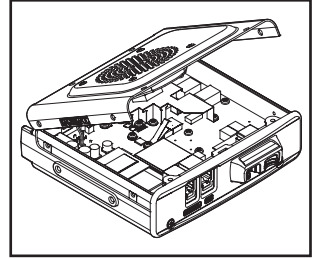

- 6 Unplug the speaker cables extending from the top cover from the socket of the board inside the main body first before removing the cover

Caution Hold the connector when unplugging the cable without pulling the cable itself.

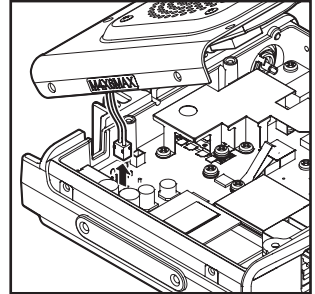

- 7 Refer to the figure on the right to mount the FVS-2

Caution Check the direction of the connector and plug the FVS-2 in all the way to the back.

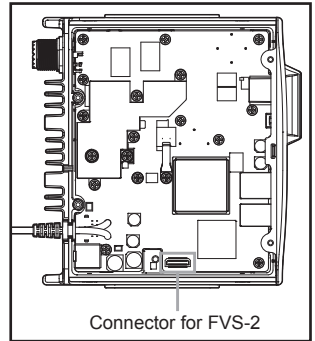



- 8 Plug in the speaker cables extending from the main body top cover to the original socket on the board
- 9 Attach the main body top cover and secure using the screws eight

Using the voice memory

The voice memory is a function for recording the audio received. The audio is saved in FVS-2 that is mounted to the radio. The saved audio can be replayed on the radio and erased later.

Setting the voice memory operation

- 1 Switch on the power supply to the radio
- 2 Press  for one second or longer
The set-up menu will be displayed.
- 3 Touch **[OPTION]**
- 4 Select and touch **[3 VOICE MEMORY]**
The screen for the detailed settings will be displayed.
- 5 Touch **[PLAY/REC]** to set the recording time
The setting will switch between “FREE 5min” and “LAST 30sec” each time it is touched.
“FREE 5min”: A total of 5 minutes of audio in 8 recording areas can be recorded.
“LAST 30sec”: The last 30 seconds will be recorded.
Tip Factory default value: FREE 5 min
- 6 Press  for one second or longer
The display will return to the previous screen.

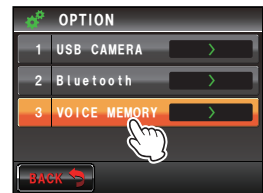
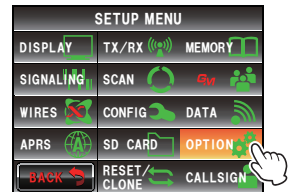

Recording the receive audio

- 1 Press **[F REC]**

The function menu will be displayed.

- 2 Touch **[REC]**

The recording will be started.

- Tips**
- When **[REC]** is not displayed in the menu, use **[BACK]** or **[FWD]** to switch the menu.
 - Set the recording time set using “**OPTION**” → “**3 VOICE MEMORY**” in the set-up menu will be displayed under **[REC]**.

- 3 Touch **[STOP]**

The recording will stop.

The track number of the audio recorded will be displayed under **[PLAY TRACK]**.



- 4 Press **[F REC]**

The display will return to the previous screen.

Replaying the recorded audio

- 1 Press **[F REC]**

The function menu will be displayed.

- 2 Touch **[PLAY/REC]** to select the track number to be replayed

- Tips**
- This is not available if there is only one recording.
 - When there are two or more recordings, the track number will change in the order “ALL”, “1”, “2”... each time it is touched.
 - All recorded tracks will be replayed in sequence when “ALL” is selected.



Optional receive Audio Record and Playback

3 Touch [PLAY]

Replay will be started.

The replay will stop automatically at the end of the selected track.



Touch [STOP] to stop the replay.



4 Press

The display will return to the previous screen.

Erasing the recorded audio

1 Press

The function menu will be displayed.

2 Touch [CLR]

The confirmation screen will be displayed.



3 Touch [OK?]

Erasure will be started.

Caution All recorded audio will be erased. When there are two or more recordings, the track number to be erased cannot be chosen.

When the recordings are erased, [ALL] will be displayed under [PLAY TRACK].



4 Press

The display will return to the previous screen.

Listening to the frequency voice announcement

Setting the announce function operation

Set the following voice announcement parameters.

- Automatically reading out the frequency or not
- Reading out the frequency in English or Japanese
- Reading out aloud
- Mute the receive audio during a voice announcement or replaying recorded audio.

1 Press **[DISP/SCAN]** for one second or longer
The set-up menu will be displayed.

2 Touch **[OPTION]**

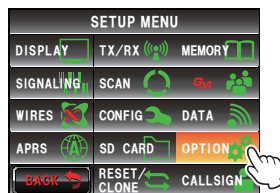

3 Select and touch **[3 VOICE MEMORY]**
The screen for the detailed settings will be displayed.

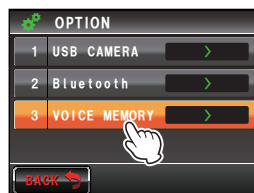

4 Touch **[ANNOUNCE]** to select the condition for reading out of the frequency

The setting will switch between “AUTO”, “OFF” and “MANUAL” each time it is touched.

“AUTO”: The frequency is read out when the band is changed after touching **[VOICE]**.

“OFF”: The frequency is not read out.

“MANUAL”: The frequency is read out when **[VOICE]** is touched.

Tip Factory default value: AUTO

5 Touch **[LANGUAGE]** to select the language in which to read out the frequency

The setting will switch between “ENGLISH” and “JAPANESE” each time it is touched.

Tip Factory default value: ENGLISH



Optional receive Audio Record and Playback

- 6 Touch **[VOLUME]** to select the announcement volume
The setting will switch between “HIGH”, “MID” and “LOW” each time it is touched.

Tip Factory default value: HIGH



- 7 Touch **[RX MUTE]** to select ON/OFF
The setting will switch between “ON” and “OFF” each time the symbol is touched.

ON: The receive audio will be muted during a voice announcement or replaying recorded audio.

OFF: The receive audio will not be muted during a voice announcement or replaying recorded audio.

Tip Factory default value: ON



- 8 Press **[DSP]** for one second or longer

The announce function operation will be set and the display will return to the previous screen.

Listening to the frequency voice announcement

(1) When the operation is set to “AUTO”

The frequency of the operating band will be automatically announced in the following cases.

- When the VFO mode and memory mode are switched
- When the operating band is changed

Tips

- The frequency will also be announced when **[VOICE]** is touched.
- The volume may be adjusted by turning  of the operating band.

(2) When the operation is set to “MANUAL”

- 1 Press **[F]**
The function menu will be displayed.
- 2 Touch **[VOICE]**
The frequency of the operating band will be announced.



Tip

- The volume can also be adjusted by turning  of the operating band.

Copying the Radio Data to another Transceiver

The memory channels and settings in the set-up menu can be copied to another FTM-400XDR/DE. This is convenient when matching the settings of fellow stations that you communicate with frequently.

Using the micro-SD card

The data files saved in the FTM-400XDR/DE can be selected and copied to a micro-SD card.

Copying data to a micro-SD card

- 1 Insert the micro-SD card into the main body card slot
- 2 Press **[DISP/STAND]** for one second or longer
The set-up menu will be displayed.
- 3 Touch **[SD CARD]**
The menu list will be displayed.

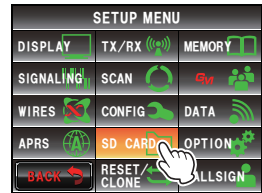

- 4 Select and touch **[1 BACKUP]**
The screen for selecting the copy direction will be displayed.

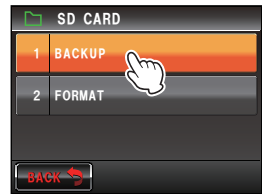

- 5 Touch **[Write to SD]**
The screen for selecting the data files to be copied will be displayed.
“ALL”: Copies all data.
“MEMORY”: Copies only the memory channels and position information for backtrack use.
“SETUP”: Copies only the settings in the set-up menu.

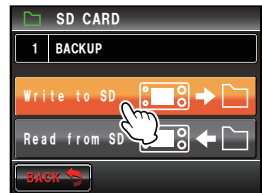

- 6 Select and touch the file to be copied
The confirmation screen will be displayed.

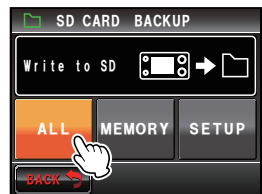

Copying the Radio Data to another Transceiver

7 Touch [OK?]

The data selected in Step 6 will be copied to the micro-SD card.

“Completed” will be displayed when the copying is completed.

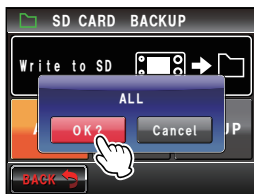

8 Press **[DISP/GRAPH]** for one second or longer

The display will return to the previous screen.

Copying data from the micro-SD card

1 Insert the micro-SD card into the FTM-400XDR/DE where the data is stored and copy the data to the card

2 Remove the micro-SD card and insert it into the FTM-400XDR/DE that the data is going to be copied to

3 Press **[DISP/GRAPH]** for one second or longer
The set-up menu will be displayed.

4 Touch [SD CARD]

The menu list will be displayed.

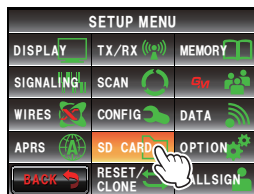

5 Select and touch [1 BACKUP]

The screen for selecting the copy direction will be displayed.



6 Touch [Read from SD]

The screen for selecting the data files to be copied will be displayed.

“ALL”: Copies all data.

“MEMORY”: Copies only the memory channels and position information for backtrack use.

“SETUP”: Copies only the settings in the set-up menu.

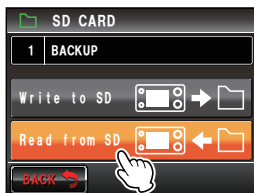

- 7 Select and touch the data to be copied

The confirmation screen will be displayed.

Tip Data that has not been saved in the micro-SD card cannot be touched.

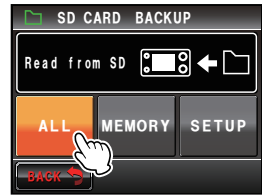

- 8 Touch [OK?]

The data selected in Step 7 will be copied to the micro-SD card.

“Completed” will be displayed when the copying is completed.

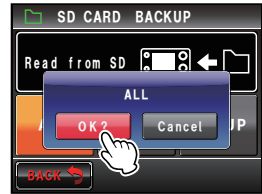

- 9 Press **[DISP/SEND]** for one second or longer

The display will return to the previous screen.

Tip

The group and member information saved in the memory using the GM function can be copied using the micro-SD card. Refer to the separate Operating Manual GM Edition for details (download the manual from the YAESU website).

Using the clone function

Using the clone function, all the data saved in the radio can be copied directly to another FTM-400XDR/DE.

Example: When using the clone function in two FTM-400XDR/DEs

- 1 Turn both FTM-400XDR/DEs OFF
- 2 Plug in the optional clone cable “CT-166” into the respective [DATA] jacks at the back of the main bodies

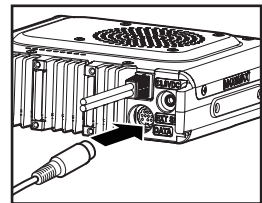

- 3 Turn both FTM-400XDR/DEs ON
 - 4 Press **[DISP/SEND]** for one second or longer
- The set-up menu will be displayed.

Copying the Radio Data to another Transceiver

5 Touch [RESET/CLONE]

The menu list will be displayed.

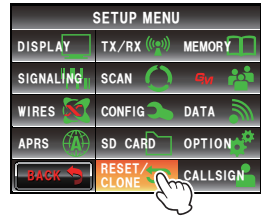

6 Select and touch [7 CLONE]

The screen for selecting the copy direction will be displayed.



7 Select and touch [This radio → other]

in the FTM-400XDR/DE where the data is going to be copied from

The confirmation screen will be displayed.



8 Select and touch [Other → This radio]

in the FTM-400XDR/DE where the data is going to be copied to

The confirmation screen will be displayed.

9 Touch [OK?]

The data will be copied.

“Completed” will be displayed when the copying is completed.



10 Press for one second or longer

The display will return to the previous screen.

11 Switch OFF both of the FTM-400XDR/DEs and disconnect the clone cable

Cautions

- When “ERROR” is displayed during the copy (clone) operation, check the connection of the clone cable and start the clone operation all again.
- When the operation is terminated before completion due to loss of power during the copy (clone) operation, the FTM-400XDR/DE where the data is being copied to will automatically be reset. Check if there is any abnormality in the power supply and start the cloning operation over again

Using the Radio with an External Device Connected

The provided PC connection cable “SCU-20” and other optional cables can be used to connect the radio to a personal computer as a COM port for the following operations.

- Transmitting your own station position information to the personal computer for incorporation into the map software
- Updating the firmware of the radio
- Packet communication

Use the [DATA] jack at the back of the main body to connect with the personal computer. The pin assignment of the [DATA] jack is as follows.

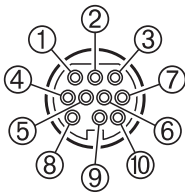

- ① PKD (packet data input) (300 mVp-p)
- ② GND
- ③ PSK (PTT)
- ④ RX 9600 (9600 bps packet data output)
- ⑤ RX 1200 (1200 bps packet data output) (300 mVp-p)
- ⑥ PK SQL (squelch control)
- ⑦ TXD (serial data output [transceiver → PC])
- ⑧ RXD (serial data input [transceiver ← PC])
- ⑨ CTS (data communication control)
- ⑩ RTS (data communication control)

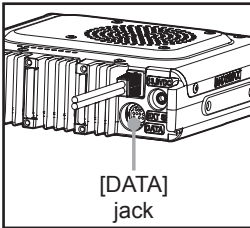

Connecting to a personal computer

● Preparations

- Personal computer
- PC connection cable “SCU-20” (accessories)... when connecting to the USB terminal of a personal computer

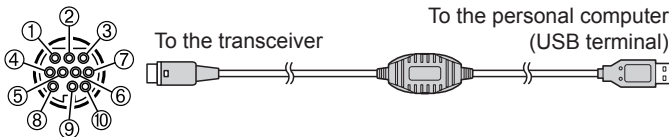

- ① PKD (packet data input)
- ② GND
- ③ PSK (PTT)
- ④ RX 9600 (9600 bps packet data output)
- ⑤ RX 1200 (1200 bps packet data output)
- ⑥ PK SQL (squelch control)
- ⑦ TXD (serial data output [transceiver → PC])
- ⑧ RXD (serial data input [transceiver ← PC])
- ⑨ CTS (data communication control)
- ⑩ RTS (data communication control)

Using the Radio with an External Device Connected

- Data cable “CT-165” (optional)... when connecting to the RS-232C terminal of a personal computer

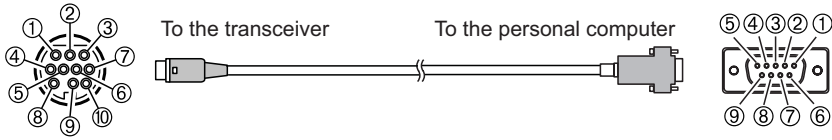

- ① -
- ② GND
- ③ -
- ④ -
- ⑤ -
- ⑥ -
- ⑦ TXD (serial data output [transceiver → PC])
- ⑧ RXD (serial data input [transceiver ← PC])
- ⑨ CTS (data communication control)
- ⑩ RTS (data communication control)

- ① -
- ② TXD (serial data output [transceiver → PC])
- ③ RXD (serial data input [transceiver ← PC])
- ④ -
- ⑤ GND
- ⑥ -
- ⑦ CTS (data communication control)
- ⑧ RTS (data communication control)
- ⑨ -

Tips

- Make sure to switch off the power to the radio first before connecting.
- When using the PC connection cable “SCU-20”, a dedicated driver needs to be installed in the personal computer. Download and use the driver and installation manual from the YAESU website.

Sending position information to the computer

- 1 Turn the radio ON
- 2 Press **[DSP]** for one second or longer
The set-up menu will be displayed.
- 3 Touch **[DATA]**
The menu list will be displayed.
- 4 Select and touch **[1 COM PORT SETTING]**
The screen for the detailed settings will be displayed.

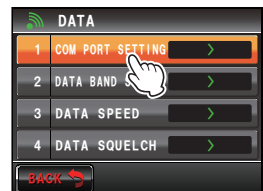
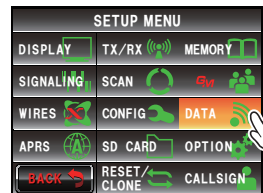

5 Touch [OUTPUT] to select “GPS OUT”

The setting changes as follows each time it is touched.

“OFF(camera)” → “GPS OUT” → “PACKET” → “WAYPOINT”

Tip Factory default value: OFF (camera)

Caution The snapshot function of the speaker microphone with camera will be inactivated when this is set to “OFF (camera)”.

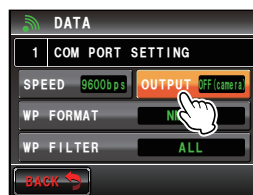

6 Touch [SPEED] to select the communication speed of the COM port

The setting changes as follows each time it is touched.

“4800 bps” → “9600 bps” → “19200 bps” → “38400 bps” → “57600 bps”

Tip Factory default value: 9600 bps

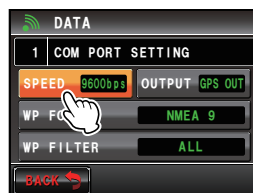

7 Press [DISP/CRSD] for one second or longer

The display will return to the previous screen.

The output of the position information data will start, and your own position information will be transmitted to the personal computer at intervals of about a second.

Tip

An operating software using NMEA-0183 standard GGA and RMC sentence is required to use the position information.

Updating the firmware of the radio

The firmware of the radio can be updated by connecting to a personal computer when Updated firmware is available.. Download and use the updated version of the firmware and the update manual from the YAESU website.

Using the radio as a transceiver for packet communication

Packet communication via this radio is possible by connecting this radio to the TNC (terminal node controller).

● Preparations

- TNC
- Personal computer
- Data cable* ... Prepare a data cable to match the connecting device

* We supply the following optional products.

- Data cable “CT-167” (optional)

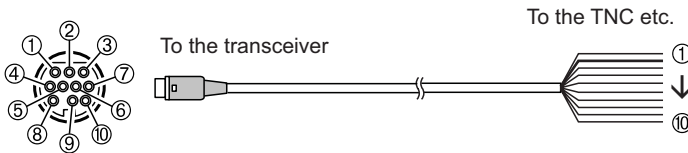

- ① PKD (packet data input)
- ② GND
- ③ PSK (PTT)
- ④ RX 9600 (9600 bps packet data output)
- ⑤ RX 1200 (1200 bps packet data output)
- ⑥ PK SQL (squelch control)
- ⑦ TXD (serial data output [transceiver → PC])
- ⑧ RXD (serial data input [transceiver ← PC])
- ⑨ CTS (data communication control)
- ⑩ RTS (data communication control)

- ① Brown PKD (packet data input)
- ② Black thick wire GND
- ③ Red PSK (PTT)
- ④ Orange RX 9600 (9600 bps packet data output)
- ⑤ Yellow RX 1200 (1200 bps packet data output)
- ⑥ Green PK SQL (squelch control)
- ⑦ Blue TXD (serial data output [transceiver → PC])
- ⑧ Grey RXD (serial data input [transceiver ← PC])
- ⑨ White CTS (data communication control)
- ⑩ Black RTS (data communication control)

- Data cable “CT-164” (optional)

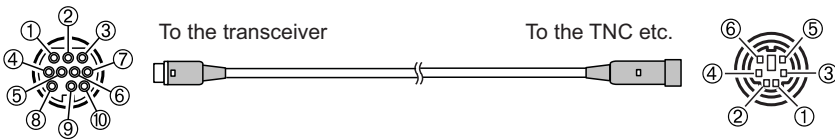

- ① PKD (packet data input)
- ② GND
- ③ PSK (PTT)
- ④ RX 9600 (9600 bps packet data output)
- ⑤ RX 1200 (1200 bps packet data output)
- ⑥ PK SQL (squelch control)
- ⑦ -
- ⑧ -
- ⑨ -
- ⑩ -

- ① PKD (packet data input)
- ② GND
- ③ PSK (PTT)
- ④ RX 9600 (9600 bps packet data output)
- ⑤ RX 1200 (1200 bps packet data output)
- ⑥ PK SQL (squelch control)

- Data cable “CT-163” (optional)

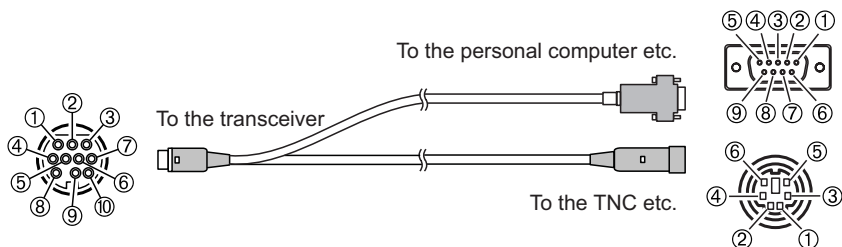

- ① PKD (packet data input)
- ② GND
- ③ PSK (PTT)
- ④ RX 9600 (9600 bps packet data output)
- ⑤ RX 1200 (1200 bps packet data output)
- ⑥ PK SQL (squelch control)
- ⑦ TXD (serial data output [transceiver → PC])
- ⑧ RXD (serial data input [transceiver ← PC])
- ⑨ CTS (data communication control)
- ⑩ RTS (data communication control)

Dsub 9 pin

- ① -
- ② TXD (serial data output [transceiver → PC])
- ③ RXD (serial data input [transceiver ← PC])
- ④ -
- ⑤ GND
- ⑥ -
- ⑦ CTS (data communication control)
- ⑧ RTS (data communication control)
- ⑨ -

DIN 6 pin

- ① PKD (packet data input)
- ② GND
- ③ PSK (PTT)
- ④ RX 9600 (9600 bps packet data output)
- ⑤ RX 1200 (1200 bps packet data output)
- ⑥ PK SQL (squelch control)

Tips

- Make sure to turn the power to the radio OFF before connecting.
- Refer to the operating manual of the TNC used on how to connect the TNC to a personal computer.
- RF receive interference may occur because of noise occurring in the personal computer.
When signals cannot be received normally, keep the personal computer at a distance away from the radio and use a photo-coupler and noise filter to connect.

Using the Radio with an External Device Connected

● Set the packet communication operation

- 1 Turn the radio ON
- 2 Press **[DMSF/DMSR]** for one second or longer
The set-up menu will be displayed.
- 3 Touch **[DATA]**
The menu list will be displayed.

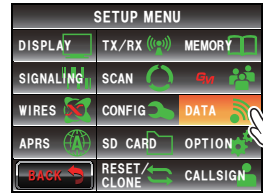

- 4 Select and touch **[1 COM PORT SETTING]**
The screen for the detailed settings will be displayed.

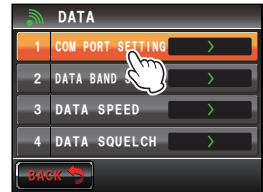

- 5 Touch **[OUTPUT]** to select "PACKET"
The setting changes as follows each time it is touched.
"OFF(camera)" → "GPS OUT" → "PACKET" → "WAYPOINT"

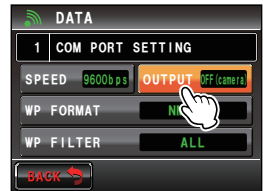

Tip Factory default value: OFF (camera)

Caution The snapshot function of the speaker microphone with camera will be inactivated when this is set to "OFF (camera)".

- 6 Touch **[SPEED]** to select the communication speed of the COM port
The setting changes as follows each time it is touched.
"4800 bps" → "9600 bps" → "19200 bps" → "38400 bps" → "57600 bps"

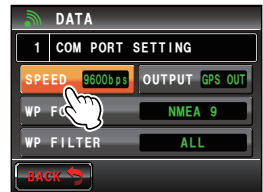

Tip Factory default value: 9600 bps

- 7 Touch **[BACK]**
- 8 Select and touch **[2 DATA BAND SELECT]**
The screen for the detailed settings will be displayed.

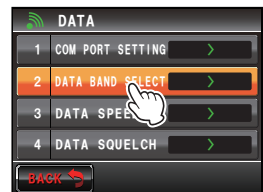

- 9** Touch **[DATA]** to select the band to be used for the packet communication

The setting changes as follows each time it is touched.

“A-BAND FIX” → “B-BAND FIX” → “A=TX/B=RX” → “A=RX/B=TX” → “MAIN BAND” → “SUB BAND”

- Tip**
- Refer to “Data communication settings” (P.196) for details.
 - Factory default value: B-BAND FIX

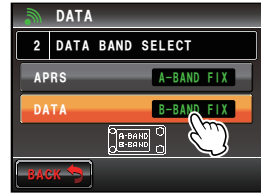

- 10** Touch **[BACK]**

- 11** Select and touch **[3 DATA SPEED]**

The screen for the detailed settings will be displayed.

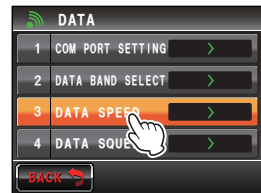

- 12** Touch **[DATA]** to select the packet communication speed

The setting will switch between “1200 bps” and “9600 bps” each time it is touched.

- Tip** Factory default value: 1200 bps

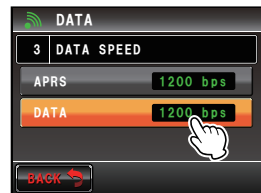

- 13** Touch **[BACK]**

- 14** Select and touch **[4 DATA SQUELCH]**

The screen for the detailed settings will be displayed.

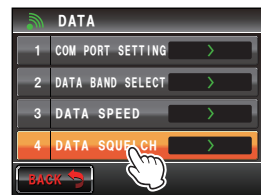



- 15** Touch **[DATA]** to select the squelch detection method for the packet communication

The setting switches between “RX BAND” and “TX/RX BAND” each time it is touched.

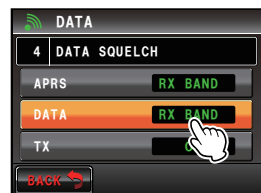
- Tip**
- Refer to “Data communication settings” (P.196) for details.
 - Factory default value: RX BAND



Using the Radio with an External Device Connected

- 16 Press  for one second or longer
The display will return to the previous screen.
Packet communication will be enabled.
- 17 Choose the band and frequency according to the settings in the set-up menu
- 18 Turn  of the receive band
The output level to TNC from the radio will be set.
- 19 Adjust the TNC output level
The input level to the radio will be set.

Caution

When transmitting a large volume of data, the transmission time gets longer and the radio will get heated up. When transmission continues for a long period of time, the overheating prevention circuit will act to lower the transmit power output. When transmission is continued further, transmission will be suspended automatically and the radio will go into the receive mode in order to prevent failure due to overheating.

When the overheating prevention circuit is activated and the radio goes into the receive mode, either switch turn OFF the power, or wait until the temperature drops in the reception mode.

Other devices that can be connected

● External speaker

An optional high output and high sound quality waterproof external speaker “MLS-200-M10” can be connected.

Plug the external speaker into the [EXT SP] jack at the back of the main body.

Tip

When an external speaker is connected to the [EXT SP] jack, there will be no sound from the internal speaker.

If you connect an External Speaker other than the MLS-200-M10 to the [EXT SP] Jack, use a **Stereo** Speaker only (Do not connect a **Monaural** Speaker plug directly into the [EXT SP] Jack.)

If you wish to connect a **Monaural** Speaker to the [EXT SP] Jack, use the supplied "Stereo to Monaural Plug" (see figure).

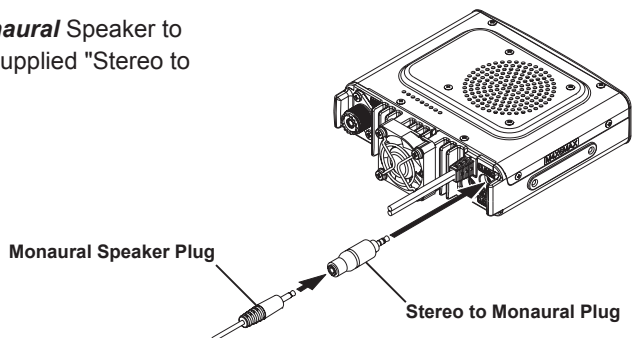

Using the set-up menu, the various functions of the radio can be customized to match your individual preferences and type of use. The functions are divided into menus such as display, transmission and reception, memory, device configuration etc.. It is easy to select the items that you would like to adjust from the respective lists and enter or select the settings that are easy to use.

Set-up Menu Basic Operations

- 1 Press **[DISP/STAND]** for one second or longer

The set-up menu will be displayed.

- 2 Touch the menu item

The menu list will be displayed.

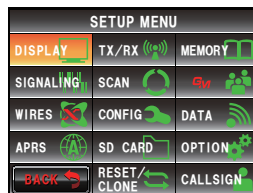

- 3 Select the item to be set

Turn **[MENU]** or touch the item.

The item will turn orange in color.

Tip Turn **[MENU]** to select items that are not visible on the screen.

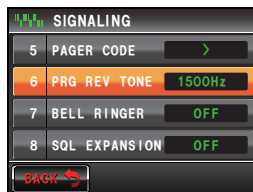

- 4 Change the set values

Press **[MENU]** briefly or touch the item.

The set value will change each time it is pressed or touched.

Tip When ">" is displayed in the set value field, pressing **[MENU]** or touching an item will display the screen with the detailed settings.

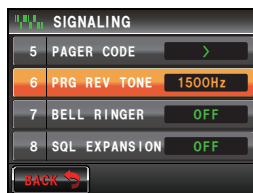

- 5 Press **[DISP/STAND]** for one second or longer, or press **[PTT]** on the microphone

The chosen value will be confirmed and the display will return to the previous screen.

- Tips**
- The chosen value can also be confirmed by pressing **[ENT]** briefly.
 - When setting additional items in the same menu next, touch **[BACK]**. The set value will be confirmed and the display will return to the menu list screen.
 - When **[BACK]** is touched in any of the screens, the display will return to the previous screen.

Tip

When a set menu item is touched again, and the menu list is displayed, a screen in which a previously set item is already selected (displayed in orange color) will be displayed.

Set-up Menu List

Menu / Item		Explanation of function	Available settings (Default values shown in BOLD)
DISPLAY			
1	DISPLAY SELECT	Screen display settings when [DISP] is pressed briefly	ALTITUDE: ON / OFF TIMER/CLOCK: ON / OFF GPS INFO: ON / OFF
2	TARGET LOCATION	Switch between the compass screen and the latitude and longitude display screen when using the GPS and GM functions	COMPASS / NUMERIC
3	BACKGROUND COLOR	Set the display background color	ORANGE / GREEN / BLUE / PURPLE / GRAY
4	BAND SCOPE	Scope Display width setting	NARROW / WIDE
5	LCD BRIGHTNESS	Touch panel brightness	MIN / 2 / 3 / 4 / 5 / 6 / MAX
6	LCD CONTRAST	Touch panel contrast	-3 / -2 / -1 / 0 / +1 / +2 / +3
7	TIME/VDD	Time / Voltage Display setting	TIME / VDD
TX/RX			
	MODE	Setting the signal format in the analog mode	AUTO (FM) / FM / NARROW FM / AM
DIGITAL			
1	AMS TX MODE	Set the AMS transmission mode	TX M / TX FM FIXED / TX DN FIXED / TX VW FIXED / AUTO
2	DIGITAL POPUP TIME	Information screen pop-up time	OFF / 2 sec / 4 sec / 6 sec / 8 sec / 10 sec / 20 sec / 30 sec / 60 sec / CONTINUE
3	LOCATION SERVICE	Own (MY) position display setting in the digital mode	ON / OFF Refer to the separate Operating Manual GM Edition for details on the functions.
4	STANDBY BEEP	Standby Beep setting	ON / OFF
5	DSP VERSION	DSP version display	Ver. 2.** (cannot be edited; differs depending on the time of release)
AUDIO			
1	SUB BAND MUTE	Sub-band mute setting	OFF / ON
2	MIC GAIN	Microphone sensitivity setting	MIN / LOW / NORMAL / HIGH / MAX
MEMORY			
1	ALPHA TAG SIZE	Display size setting of memory channel tag	SMALL / LARGE
2	MEM SCAN TYPE	Scanning method setting during memory scan	ALL MEM / SELECT MEM
SIGNALING			
1	TONE SQL FREQ	Tone frequency (CTCSS)	67.0Hz - 254.1 Hz 88.5 Hz
2	DCS CODE	DCS code setting	023 - 754
3	AUTO DIALER	DTMF code automatic transmission setting	OFF / ON
4	DTMF MEMORY	DTMF code registration	1 - 9 ways 16 characters each
5	PAGER CODE	Pager individual code setting	RX CODE : 01 - 50 05 RX CODE 2: 01 - 50 47 TX CODE 1: 01 - 50 05 TX CODE 2: 01 - 50 47

Menu / Item		Explanation of function	Available settings (Default values shown in BOLD)
SIGNALING			
6	PRG REV TONE	User programmed reverse tone frequency	300 Hz - 3000 Hz 1500 Hz
7	BELL RINGER	Recall sound length setting	OFF / 1 time / 3 times / 5 times / 8 times / CONTINUOUS
8	SQL EXPANSION	Separate squelch type setting for transmit and receive	OFF / ON
9	WX ALERT (USA Version Only)	Weather alert operation setting	OFF / ON
SCAN			
1	DUAL WATCH STOP	Setting the signal reception method	AUTO / HOLD
2	SCAN DIRECTION	Scanning direction setting	UP / DOWN
3	SCAN RESUME	Set the resume operation after scan stop	BUSY / HOLD / 1 sec / 3 sec / 5 sec
GM			
1	DP-IP LIST	Displays the DP-ID list screen.	-
2	RANGE RINGER	Bell sound setting when checking for stations within sphere of communications	OFF / ON
3	RADIO ID CHECK	Specific ID display by transceiver	- (cannot be edited)
* Refer to the separate Operating Manual GM Edition for details on the functions.			
WIRES X			
1	RPT/WIRES FREQ	Setting of operating frequency in repeater / WIRES-X	MANUAL / PRESET
	PRESET FREQUENCY	Registration of the preset frequency	144.000 - 146.000 144.620
2	SEARCH SETUP	Setting the WIRES ROOM selection method	HISTORY / ACTIVITY
3	EDIT CATEGORY TAG	Editing the category tag	C1 - C5
4	REMOVE ROOM/NODE	Deletion of the registered categories	C1 - C5
5	DG-ID	Set the DG-ID number for WIRES-X.	AUTO / 01 - 99
* Refer to the separate Operating Manual WIRES-X Edition for details on the functions.			
CONFIG			
1	DATE & TIME ADJUST	Setting the date and time	-
2	DATE & TIME FORMAT	Setting the date and time display formats	DATE: mmm/dd/yyyy / yyyy/mmm/dd / dd/mmm/yyyy / yyyy/dd/mmm TIME: 24 hour / 12 hour
3	TIME ZONE	Time zone setting	UTC±14: 00 (0.5 h interval) UTC +0: 00
4	AUTO RPT SHIFT	Auto repeater shift setting	OFF / ON
5	RPT SHIFT	Repeater shift direction setting	OFF / - / + (Differs depending on frequency)

Set-up Menu List

Menu / Item		Explanation of function	Available settings (Default values shown in BOLD)
CONFIG			
6	RPT SHIFT FREQ	Repeater TX offset setting	0.00 - 99.95 MHz (Differs depending on frequency)
7	FM AM STEP	Channel step setting	AUTO / 5.00 KHz / 6.25 KHz / 10.00 KHz / 12.50 KHz / 15.00 KHz / 20.00 KHz / 25.00 KHz / 50.00 KHz / 100.00 KHz
8	BEEP	Beep setting	OFF / LOW / HIGH
9	CLOCK TYPE	Clock shift setting	A / B
10	MIC PROGRAM KEY	Microphone P buttons setting	OFF (disable the P button) / BAND SCOPE / SCAN / HOME / DCS CODE / TONE FREQ / RPT SHIFT / REVERSE / TX POWER / SQL OFF / T-CALL / VOICE / D_X / WX / S-LIST / MSG / REPLY / M-EDIT P1: SQL OFF (T-CALL: European version) P2: HOME P3: D_X P4: TX POWER
11	RX COVERAGE	Reception range expansion setting	NORMAL / WIDE
12	UNIT	Display unit setting	METRIC / INCH (Depends on the transceiver version)
13	APO	Automatic power OFF operating time	OFF / 0.5 hour - 12.0 hour
14	TOT	TX time out setting	OFF / 1 min - 5 min - 30 min
15	Bluetooth PAIRING	PIN code setting and pairing start	0000 - 9999 6111
16	GPS DATUM	GPS function positioning selection	WGS-84 / TOKYO MEAN
17	GPS DEVICE	GPS receiver selection	INTERNAL / EXTERNAL
18	GPS LOG	GPS access time setting	OFF / 1 sec - 60 sec
DATA			
1	COM PORT SETTING	COM port setting	SPEED: 4800 bps / 9600 bps / 19200 bps / 38400 bps / 57600 bps OUTPUT: OFF (camera) / GPS OUT / PACKET / WAYPOINT WP FORMAT: NMEA 6 / NMEA 7 / NMEA 8 / NMEA 9 WP FILTER: ALL / MOBILE / FREQUENCY / OBJECT/ITEM / DIGIPEATER / VoIP / WEATHER / YAESU / CALL RINGER / RNG RINGER
2	DATA BAND SELECT	APRS/DATA band selection setting	APRS: MAIN BAND / SUB BAND / A-BAND FIX / B-BAND FIX / A=TX/B=RX / A=RX/B=TX DATA: MAIN BAND / SUB BAND / A-BAND FIX / B-BAND FIX / A=TX/B=RX / A=RX/B=TX
3	DATA SPEED	APRS/DATA communication baud rate setting	APRS: 1200 bps / 9600 bps DATA: 1200 bps / 9600 bps

Menu / Item		Explanation of function	Available settings (Default values shown in BOLD)
DATA			
	4	DATA SQUELCH	Squelch detection setting APRS: RX BAND / TX/RX BAND DATA: RX BAND / TX/RX BAND TX: ON / OFF
APRS			
	1	APRS COMPASS	APRS compass display orientation NORTH UP / HEADING UP
	2	APRS DESTINATION	Model code display Non-editable APY400
	3	APRS FILTER	Filter function setting Mic-E: ON / OFF POSITION: ON / OFF WEATHER: ON / OFF OBJECT: ON / OFF ITEM: ON / OFF STATUS: ON / OFF OTHER: ON / OFF RANGE LIMIT: 1 mi - 3000 mi / OFF ALT.NET: ON / OFF
	4	APRS MESSAGE TEXT	Standard message text input 1 to 8 ch
	5	APRS MODEM	APRS function ON/OFF setting OFF / ON
	6	APRS MUTE	Band B AF mute setting for APRS OFF / ON
	7	APRS POP-UP	Display time setting for pop-up display of beacons and messages BEACON: OFF / 3 sec / 5 sec / 10 sec / HOLD MESSAGE: OFF / 3 sec / 5 sec / 10 sec / HOLD MYPACKET: OFF / ON
	8	APRS POP-UP COLOR	Screen color setting for pop-up display of beacons CHECK OFF / GREEN / BLUE / ORANGE / PURPLE / SKY-BLUE / YELLOW / AMBER / WHITE 1 BEACON: CHECK OFF 2 MOBILE: CHECK OFF 3 OBJECT/ITEM: CHECK OFF 4 CAL RINGER: CHECK OFF 5 RNG RINGER: CHECK OFF 6 MESSAGE: CHECK OFF 7 GRP/BULT: CHECK OFF 8 MY PACKET: CHECK OFF
	9	APRS RINGER	Bell sound setting at beacon arrival TX BEACON: ON / OFF TX MESSAGE: ON / OFF RX BEACON: ON / OFF RX MESSAGE: ON / OFF MY PACKET: ON / OFF CALL RINGER: ON / OFF RNG RINGER: 1km - 100km / OFF MSG VOICE: ON / OFF
	10	APRS RINGER (CALL)	Call sign setting for CALL RINGER 1 - 8 stations

Set-up Menu List

Menu / Item	Explanation of function	Available settings (Default values shown in BOLD)
APRS		
11	APRS TX DELAY	Data transmit delay time setting 100 ms / 150 ms / 200 ms / 250 ms / 300 ms / 400 ms / 500 ms / 750 ms / 1000 ms
12	APRS UNITS	APRS display unit setting 1 POSITION: dd°mm.mm' / dd°mm'ss" 2 DISTANCE: km / mile 3 SPEED: km/h / mph / knot 4 ALTITUDE: m / ft 5 BARO: hPa / mb / mmHg / inHg 6 TEMP: °C / °F 7 RAIN: mm / inch 8 WIND: m/s / mph / knot
13	BEACON INFO SELECT	Transmit beacon information setting AMBIGUITY: OFF / 1 - 4 digit SPEED/COURSE: ON / OFF ALTITUDE: ON / OFF
14	BEACON STATUS TEXT	Status text input setting SELECT: TEXT 1 - 5 / OFF TX RATE: 1/1 - 1/8 / 1/2 (FREQ) - 1/8 (FREQ) TEXT 1 - 5: NONE / FREQUENCY / FREQ & SQL & SHIFT
15	BEACON TX	Beacon automatic transmit / manual transmission switch AUTO: OFF / ON INTERVAL: 30 sec - 60 min 5 min PROPORTIONAL: ON / OFF DECAY: ON / OFF LOW SPEED: 1 - 99 3 RATE LIMIT: 5 sec - 180 sec 30 sec
16	DIGI PATH SELECT	Digital repeater route setting OFF / WIDE 1-1 / WIDE 1-1,WIDE 2-1 / PATH 1 - PATH 4 / FULL 1 / FULL 2
17	DIGI PATH 1	Digital repeater route address setting ADDRESS 1: - ADDRESS 2: -
18	DIGI PATH 2	ADDRESS 1: - ADDRESS 2: -
19	DIGI PATH 3	ADDRESS 1: - ADDRESS 2: -
20	DIGI PATH 4	ADDRESS 1: - ADDRESS 2: -
21	DIGI PATH FULL 1	Digital repeater route address setting ADDRESS 1: - ADDRESS 2: - ADDRESS 3: - ADDRESS 4: - ADDRESS 5: - ADDRESS 6: - ADDRESS 7: - ADDRESS 8: -
22	DIGI PATH FULL 2	ADDRESS 1: - ADDRESS 2: - ADDRESS 3: - ADDRESS 4: - ADDRESS 5: - ADDRESS 6: - ADDRESS 7: - ADDRESS 8: -

Menu / Item		Explanation of function	Available settings (Default values shown in BOLD)
APRS			
23	CALLSIGN (APRS)	My call sign setting	-
24	MESSAGE GROUP	Group filter setting for received messages	GROUP 1: ALL***** GROUP 2: CQ***** GROUP 3: QST***** GROUP 4: YAESU***** GROUP 5: - GROUP 6: - BULLETIN 1: BLN?***** BULLETIN 2: BLN? BULLETIN 3: BLN?
25	MESSAGE REPLY	Automatic response setting of received messages	REPLY: OFF / ON CALLSIGN: *****-*** REPLY TEXT: -
26	MY POSITION SET	My position setting	GPS / MANUAL
27	MY POSITION	My position manual setting	LAT: N 0°00. 00' (' 00") LON: E 0°00. 00' (' 00")
28	MY SYMBOL	My symbol setting	ICON 1: [/ >] Car ICON 2: [/ R] REC.Vehicle ICON 3: [/ -] House QTH (VHF) USER: [/ Y Y] Yaesu Radios
29	POSITION COMMENT	Position comment setting	Off Duty / En Route / In Service / Returning / Committed / Special / Priority / Custom 0 - 6 / Emergency!
30	Smart Beaconing	Smart beaconing setting	1 STATUS: OFF / TYPE 1 / TYPE 2 / TYPE 3 2 LOW SPEED: 2 - 30 5 3 HIGH SPEED: 3 - 90 70 4 SLOW RATE: 1 - 100 min 30 min 5 FAST RATE: 10 - 180 sec 120 sec 6 TURN ANGLE: 5 - 90° 28° 7 TURN SLOPE: 1 - 255 26 8 TURN TIME: 5 - 180 sec 30 sec
31	SORT FILTER	Sort function / filter function setting	SORT: TIME / CALLSIGN / DISTANCE FILTER : ALL / MOBILE / FREQUENCY / OBJECT/ITEM / DIGIPEATER / VoIP / WEATHER / YAESU / OTHER PACKET / CALL RINGER / RANGE RINGER / 1200 bps / 9600 bps
32	VOICE ALERT	Voice alert function setting	VOICE ALERT: NORMAL / TONE SQL / DCS / RX-TSQL / RX-DCS TONE SQL: 67.0 Hz - 254.1 Hz 100.0 Hz DCS: 023 - 754 023
* Refer to the separate Operation Manual APRS Edition for details on the functions.			
SD CARD			
1	BACKUP	Reading and writing information of the radio to the micro-SD card	Write to SD / Read from SD
2	FORMAT	Initializing the micro-SD card	-

Set-up Menu List

Menu / Item		Explanation of function	Available settings (Default values shown in BOLD)
OPTION			
1	USB CAMERA	Picture size / picture quality setting for the microphone with camera	PICTURE SIZE: 160 * 120 / 320 * 240 PICTURE QUALITY: LOW / NORMAL / HIGH
2	Bluetooth	Bluetooth headset setting	AUDIO: AUTO / FIX BATTERY: NORMAL / SAVE VOX: ON / OFF GAIN: HIGH / LOW
3	VOICE MEMORY	Voice memory function setting	PLAY/REC: FREE 5 min / LAST 30 sec ANNOUNCE: AUTO / OFF / MANUAL LANGUAGE: JAPANESE / ENGLISH VOLUME: HIGH / MID / LOW RX MUTE: ON / OFF
RESET/CLONE			
1	FACTORY RESET	Return all settings to default settings when shipped	-
2	PRESET	Preset registration	-
3	RECALL PRESET	Recall preset	-
4	MEM CH RESET	Erasing registered memory channels	-
5	MEM CH SORT	Sorting registered memory channels	-
6	APRS RESET	Return APRS settings to default settings when shipped	-
7	CLONE	Copy all saved data	This radio → other / Other → This radio
CALLSIGN			
	CALLSIGN	My call sign setting	-

Using the Set-up Menu

Screen display settings

Select the screen to be displayed

Set the type of screen to be displayed when pressing  briefly.

- 1 Press  for one second or longer
The set-up menu will be displayed.
- 2 Touch **[DISPLAY]**

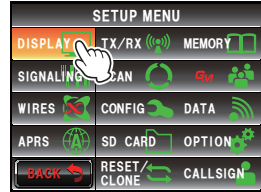

- 3 Touch **[1 DISPLAY SELECT]**
The display setting screen will be displayed.



- 4 Touch the item to be displayed
Select from “ALTITUDE”, “TIMER/CLOCK” and “GPS INFO”, the screen that you would like to display.
Each time the item is touched, the setting will switch between “ON” and “OFF”.



- 5 Set the other screens as well
Repeat Step 4 and set the other screens as well.
- 6 Press  for one second or longer
The screen to be displayed will be set and the display will return to the previous screen.

Tip Factory default value: All screens are set to “OFF”

Switching between COMPASS and POSITION INFORMATION screens

When using the GPS and GM functions, the screen will switch between the “Compass Screen” and the “Position Information (Latitude and Longitude) Display Screen”.

- 1 Press  for one second or longer
The set-up menu will be displayed.
- 2 Touch **[DISPLAY]**

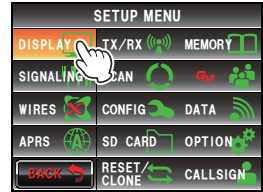

- 3 Touch **[2 TARGET LOCATION]** to select the display content

Each time this symbol is touched, the setting will switch between “COMPASS” and “NUMERIC”.

COMPASS: The compass screen will be displayed.

NUMERIC: The position information (latitude and longitude) display screen will be displayed.

Tip Factory default value: COMPASS

- 4 Press  for one second or longer
The display contents will be set and the display will return to the previous screen.



Setting the display background color

The display background color can be selected from the following 5 colors.

• Orange • Green • Blue • Purple • Grey

Refer to “Changing the background color of the frequency display area” (P.60) for details.

Setting the band scope display width

The frequency bandwidth and memory channel number to be displayed when band scope is running can be set.

- 1 Press  for one second or longer
The set-up menu will be displayed.
- 2 Touch **[DISPLAY]**

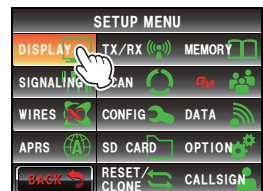

3 Touch **[4 BAND SCOPE]** to select the frequency width

The frequency bandwidth will switch between “WIDE” and “NARROW” each time this symbol is touched.

WIDE: The frequency bandwidth will be displayed using a wide search width.

NARROW: The frequency bandwidth will be displayed using a narrow search width.



	VFO mode	Memory mode
WIDE	±25 steps	±25 channels
NARROW	±12 steps	±5 channels

Tip Factory default value: WIDE

4 Press **[DISP BAND]** for one second or longer

The bandwidth of the frequency will be set and the display will return to the previous screen.

Setting the display brightness

The brightness of the touch panel can be set.

Refer to “Adjusting the display brightness” (P.58) for details.

Setting the display contrast

The contrast of the touch panel can be adjusted.

Refer to “Adjusting the display contrast” (P.58) for details.

Switching the time display and the voltage display

The display at the top right of the display can be changed between “Time Display” and “Voltage Display”.

1 Press **[DISP BAND]** for one second or longer

The set-up menu will be displayed.

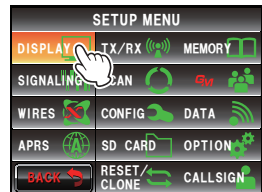
2 Touch **[DISPLAY]**

Using the Set-up Menu

- 3 Touch **[7 TIME/VDD]** to select the display content
The display content changes between “TIME” and “VDD” each time the symbol is touched.



TIME: The time will be displayed.

VDD: The voltage will be displayed.

Tip Factory default value: TIME

- 4 Press **[DISP/CHG]** for one second or longer
The display content will be set and the display will return to the previous screen.

Transmit and receive settings

Setting the signal format

The radio signal format can be selected from “FM”, “AM” and “NARROW FM” in the analog mode.

Refer to “Switching the communication mode” (P.45) for details.

Setting the AMS transmission mode

When operating in the AMS function, the transmit mode may be selected:

- 1 Press **[DISP/CHG]** for one second or longer
The set-up menu will be displayed.
- 2 Touch **[TX/RX]**

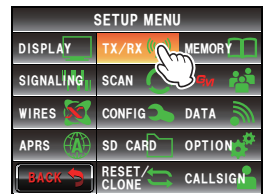

- 3 Touch **[DIGITAL]**

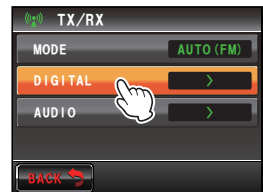

- 4 Touch [1 AMS TX MODE] to select the AMS transmit mode.

The AMS transmit mode changes in the following order each time the symbol is touched.

TX M: The operating mode is automatically selected from four communication modes to match the received signal. Pressing the Microphone [PTT] momentarily, toggles between the Digital and Analog communication modes.

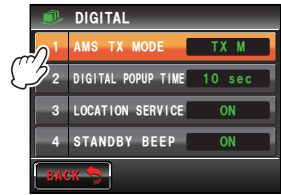

TX FM FIXED: The RX mode is automatically selected from the four communication modes to match the received signal. The TX mode is automatically changed to the "FM" mode.

TX DN FIXED: The RX mode is automatically selected from the four communication modes to match the received signal. The TX mode is automatically changed to the "DN" mode.

TX VW FIXED: The RX mode is automatically selected from the four communication modes to match the received signal. The TX mode is automatically changed to the "VW" mode.

AUTO: The RX and TX operating mode is automatically selected from the four communication modes to match the received signal.

- Tips**
- Factory default value: TX M
 - Blink "—": TX M
 - Blink "○○": TX FM FIXED / TX DN FIXED / TX VW FIXED
 - "○○": AUTO
- * The ○○ symbol display differs according to the received signal.

- 5 Press [DISP] for one second or longer

The AMS transmit mode will be set and the display will return to the previous screen.

Setting the pop-up time for the partner station information

The time that partner station information such as the call sign is displayed can be set.

- 1 Press  for one second or longer
The set-up menu will be displayed.
- 2 Touch [TX/RX]

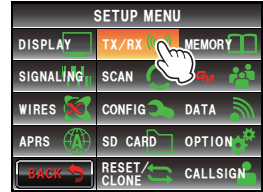

- 3 Touch [DIGITAL]



- 4 Touch [2 DIGITAL POPUP TIME] to select the pop-up time

The pop-up time changes in the following order each time the symbol is touched.

“OFF” “2sec” “4sec” “6sec” “8sec” “10sec” “20sec” “30sec” “60sec” “CONTINUE”

Tip Factory default value: 10 sec

- 5 Press  for one second or longer
The pop-up time will be set and the display will return to the previous screen.

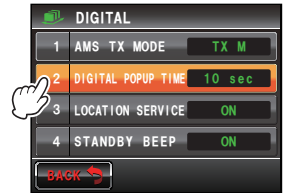

Setting the display method for my position

Refer to the separate Operating Manual GM Edition (download the manual from the YAESU website).

Setting the Standby Beep

When communicating in a digital mode, a beep is sounded after the end of the other stations transmission.

- 1 Press  for one second or longer
The set-up menu will be displayed.
- 2 Touch [TX/RX]

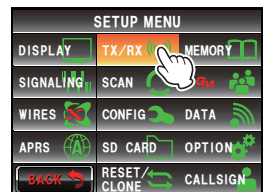

3 Touch [DIGITAL]

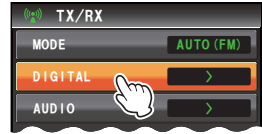

4 Touch [4 STANDBY BEEP] to select OFF/ON

The setting will switch between “ON” and “OFF” each time the symbol is touched.

OFF: Disable the STANDBY BEEP feature.

ON: Enable the STANDBY BEEP feature.

Tip Factory default value: ON

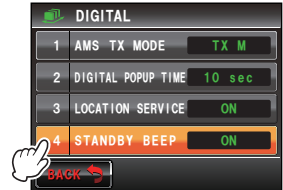

5 Press for one second or longer

The display will return to the previous screen.

Displaying the version of the DSP program

The version of the DSP program in the digital unit inside the radio can be checked.

1 Press for one second or longer

The set-up menu will be displayed.

2 Touch [TX/RX]

3 Touch [DIGITAL]

4 Touch [5 DSP VERSION]

The version of the DSP program will be displayed.

5 Press for one second or longer

The display will return to the previous screen.

Setting the sub-band mute

The receive audio of the sub-band can be automatically muted when receiving signals in the main band.

1 Press for one second or longer

The set-up menu will be displayed.

2 Touch [TX/RX]

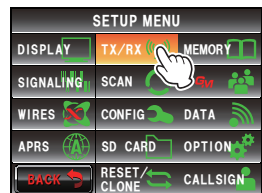

3 Touch [AUDIO]



4 Touch [1 SUB BAND MUTE] to select OFF/ON

The setting will switch between “ON” and “OFF” each time the symbol is touched.

OFF: The sub-band audio will not be muted when a signal is received on the main band.

ON: The sub-band audio will be muted when a signal is received on the main band.

Tip Factory default value: OFF



5 Press for one second or longer

The sub-band mute will be set and the display will return to the previous screen.

Setting the sensitivity of the microphone

The sensitivity (gain) of the microphone can be adjusted.

Refer to “Adjusting the sensitivity of the microphone” (P.50) for details.

Memory channel settings

Setting the display method for the memory tag

The display format for the name and frequency assigned to a memory can be selected for each channel.

Refer to “Changing the method of the memory tag display” (P.71) for details.

Setting the memory scan method

The memory scan can be set to scan for all memory channels or only specified memory channels.

Refer to “Selecting the scanning method” (P.79) for details.

Tone signal settings

Setting the squelch tone frequency (CTCSS)

The tone frequency can be set. Refer to “Setting the tone frequency” (P.106) for details.

Setting the DCS code

The DCS code can be set. Refer to “Setting the DCS code” (P.108) for details.

Setting the transmission method of the DTMF code

The transmission method of the registered DTMF code can be set.

Refer to “Transmitting the registered DTMF code” (P.117) for details.

Registering the DTMF code

Telephone numbers used when connecting to a public line from a phone patch can be registered using a DTMF code up to a maximum of 16 digits.

Refer to “Registering the DTMF code” (P.116) for details.

Recalling only specified stations

The function for calling only specified stations using the pager code can be set. Refer to “Using the pager function” (P.110) for details.

Setting the user programmed reverse CTCSS tone

The frequency of the user programmed reverse CTCSS tone squelch can be set at 100 Hz intervals between 300 Hz and 3000 Hz

- 1 Press **[DISP/STAND BY]** for one second or longer
The set-up menu will be displayed.

- 2 Touch **[SIGNALING]**

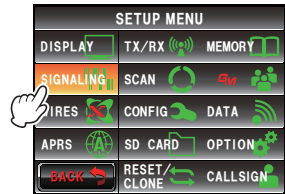

- 3 Select and touch **[6 PRG REV TONE]**

The characters of the set value will turn orange in color.

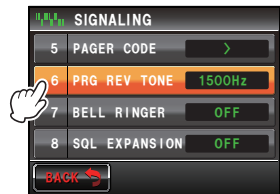

- 4 Turn **[DIAL]** to select the frequency

Tip Factory default value: 1500 Hz

- 5 Touch **[6 PRG REV TONE]**

The characters of the set value will turn green in color.

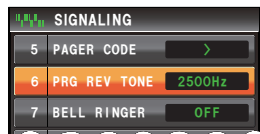

- 6 Press **[DISP/STAND BY]** for one second or longer

The frequency will be set and the display will return to the previous screen.

Using the Set-up Menu

Using the bell Notification of an incoming call from a partner station using the bell

Notification of an incoming call from a partner station can be provided by a bell sound. Refer to “Notification of an incoming call from a partner station using the bell” (P.114) for details.

Setting the squelch type separately for transmit and receive

Different squelch types can be used for transmit and receive.

- 1 Press **[DISP/SEND]** for one second or longer
The set-up menu will be displayed.
- 2 Touch **[SIGNALING]**

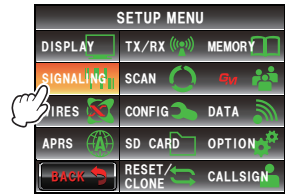

- 3 Touch **[8 SQL EXPANSION]** to select OFF/ON
The setting will switch between “OFF” and “ON” each time it is touched.



OFF: Use the same squelch for transmit and receive.
ON: Use different squelch for transmit and receive.
Refer to “Other squelch functions” (P.114) for details.

Tip Factory default value: OFF

- 4 Press **[DISP/SEND]** for one second or longer
The squelch type when transmitting and receiving will be set and the display will return to the previous screen.

Setting the weather alert operation (USA Version Only)

The reception of the weather alert can be disabled.

- 1 Press **[DISP/SEND]** for one second or longer
The set-up menu will be displayed.
- 2 Touch **[SIGNALING]**

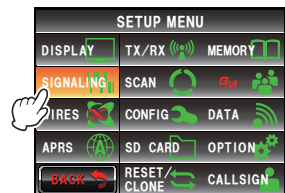

- 3 Touch **[9 WX ALERT]** to select OFF/ON
The setting will switch between “OFF” and “ON” each time it is touched.



OFF: The weather alert will not be received.

ON: The weather alert will be received.

Tip Factory default value: OFF

- 4 Press **[DMSF]** for one second or longer
The weather alert operation will be set and the display will return to the previous screen.

Scan settings

Setting the signal reception method

The reception method when a signal is picked up in the home channel can be set. Refer to “Setting the restart condition of dual receive” (P.86) for details.

Setting the scanning direction

The scanning direction can be set to scan for increasing or decreasing frequencies or memory channel numbers.

- 1 Press **[DMSF]** for one second or longer
The set-up menu will be displayed.
- 2 Touch **[SCAN]**

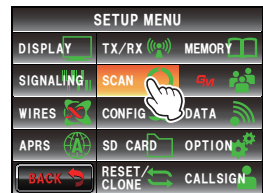

- 3 Touch **[2 SCAN DIRECTION]** to select the scanning direction
The setting will switch between “UP” and “DOWN” each time it is touched.

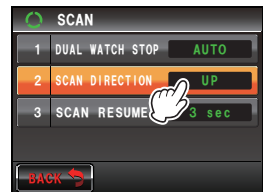

UP: Scan for increasing frequencies or memory channel numbers.

DOWN: Scan for decreasing frequencies or memory channel numbers.

Tip Factory default value: UP

- 4 Press **[DMSF]** for one second or longer
The scanning direction will be set and the display will return to the previous screen.

Setting the receive operation when the scanning stops

The reception method when the scanning stops can be set.

Refer to “Setting the receive operation when the scanning stops” (P.77) for details.

Group monitor function settings

The GM (group monitor) function automatically checks to find if there are any registered members within communication range.

Refer to the separate Operating Manual GM Edition for further details (download the operating manual from the YAESU website).

Settings on the functions and configuration

Setting the date and time

The date and time of the radio can be set.

Refer to “Adjusting the data and time” (P.56) for details.

Setting the display format for the date and time

The display format of the clock inside the radio can be changed as follows.

- Date format: Month/Day/Year format, Year/Month/Day format, Day/Month/Year format, Year/Day/Month format
- Time format: 24 hours format, 12 hours format

1 Press **[DSP MENU]** for one second or longer
The set-up menu will be displayed.

2 Touch **[CONFIG]**

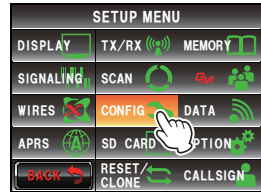

3 Touch **[2 DATE & TIME FORMAT]**

The display setting screen for the date and time will be displayed.



4 Touch **[DATE]**

The display setting screen for the date will be displayed.

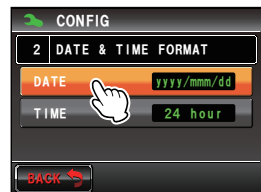

5 Touch the format to be displayed

Touch and select the date format to be displayed.

mmm/dd/yyyy: Display in Month/Day/Year format.

yyyy/mmm/dd: Display in Year/Month/Day format.

dd/mmm/yyyy: Display in Day/Month/Year format.

yyyy/dd/mmm: Display in Year/Day/Month format.

Tip Factory default value: mmm/dd/yyyy



6 Touch **[BACK]**



7 Touch **[TIME]** to select the display format for the time
The setting will switch between “24 hour” and “12 hour” each time it is touched.

Tip Factory default value: 24 hour

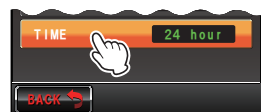

Using the Set-up Menu

- 8 Press **[DISP/SEND]** for one second or longer

The display format for the date and time will be set and the display will return to the previous screen.

Setting the time zone

The time of the clock inside the radio can be synchronized with the time in the time data (Coordinated Universal Time) from the GPS.

The time zone can be set at 0.5 hour intervals up to ± 14 hours.

- 1 Press **[DISP/SEND]** for one second or longer

The set-up menu will be displayed.

- 2 Touch **[CONFIG]**

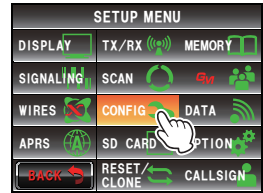

- 3 Select and touch **[3 TIME ZONE]**

The characters of the set value will turn orange in color.



- 4 Turn **[DATA]** to select the time zone

The time zone can be set at 0.5 hour intervals up to ± 14 hours.

Tip Factory default value: UTC+0:00

- 5 Touch **[3 TIME ZONE]**

The characters of the set value will turn green in color.



- 6 Press **[DISP/SEND]** for one second or longer

The time zone will be set and the display will return to the previous screen.



Setting the auto repeater shift

When communicating using the repeater, the repeater auto shift function automatically shifts the transmit frequency to match the repeater input frequency. This allows the repeater to be used by simply tuning the FTM-400XDR/DE to the repeater output frequency. This setting may be turned ON or OFF.

- 1 Press **[DISP/STAND]** for one second or longer.
The set-up menu will be displayed.
- 2 Touch **[CONFIG]**

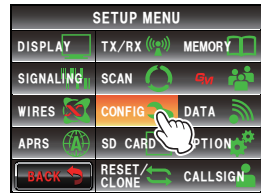

- 3 Touch **[4 AUTO RPT SHIFT]** to select ON/OFF.
The setting will switch between “ON” and “OFF” each time it is touched.



ON: The auto repeater shift function will be switched on.

OFF: The auto repeater shift function will be switched off.

Tip Factory default value: ON

- 4 Press **[DISP/STAND]** for one second or longer.
The auto repeater shift will be set and the display will return to the previous screen.

Setting the direction of the repeater shift

The direction of the repeater shift function can be set.

- 1 Press **[DISP/STAND]** for one second or longer.
The set-up menu will be displayed.
- 2 Touch **[CONFIG]**

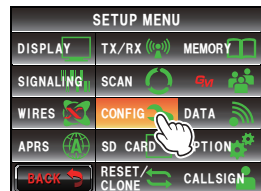

Using the Set-up Menu

- 3 Touch **[5 RPT SHIFT]** to select the shift direction
The setting will switch between “OFF”, “-” and “+” each time it is touched.

OFF: The transmit frequency will not shift.

-: The transmit frequency will shift down.

+: The transmit frequency will shift up.

Tip Factory default value: Differs depending on frequency

- 4 Press **[DISP MENU]** for one second or longer

The direction of the repeater shift will be set and the display will return to the previous screen.



Setting the shift width of the repeater

The offset frequency of the repeater shift function can be set.

- 1 Press **[DISP MENU]** for one second or longer
The set-up menu will be displayed.
- 2 Touch **[CONFIG]**

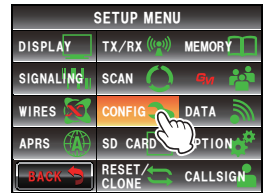

- 3 Select and touch **[6 RPT SHIFT FREQ]**
The characters of the set value will be displayed in orange color.

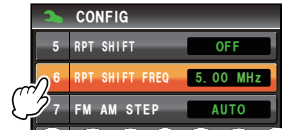

- 4 Turn **[ROTARY]** to set the shift offset frequency

The shift width can be set at 0.05 MHz intervals between 0.00 MHz and 99.95 MHz.

Tip Factory default value: Differs depending on frequency



5 Touch [6 RPT SHIFT FREQ]

The characters of the set value will turn green in color.

**6 Press [DISP/STAND]** for one second or longer

The offset of the repeater shift function will be set and the display will return to the previous screen.

**Setting the frequency step**

The change in the frequency when the tuning knob is turned, or when the key is pressed can be set.

Refer to “Changing the frequency step” (P.41) for details.

Setting the volume of the beep

The confirmation sound (beep) that goes off when a key is pressed can be changed.

Refer to “Changing the beep volume” (P.54) for details.

Setting the clock shift of the CPU

The clock signal of the CPU can be changed so that it is not heard as an internal spurious signal by the receiver. Select “A” during normal operation.

1 Press [DISP/STAND] for one second or longer

The set-up menu will be displayed.

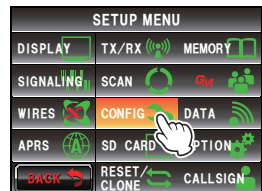
2 Touch [CONFIG]**3 Touch [9 CLOCK TYPE]** to set the clock type

The setting switches between “A” and “B” each time it is touched.

A: The clock shift operation will automatically switch on and off.

B: The clock shift will be kept in operation at all times.



Tip Factory default value: A

Using the Set-up Menu

- Press **[DISP SETUP]** for one second or longer
The clock shift type will be set and the display will return to the previous screen.

Setting the program key of the microphone

Functions can be assigned to the program keys (P1 to P4) of the provided microphone (MH-48).

- Press **[DISP SETUP]** for one second or longer
The set-up menu will be displayed.
- Touch **[CONFIG]**

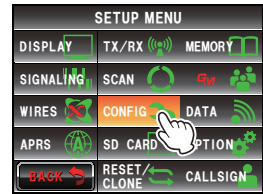

- Touch **[10 MIC PROGRAM KEY]**
The setting screen for the microphone program key will be displayed.



- Touch the program key (P1 to P4) where the function is going to be assigned
The functions that can be assigned will be displayed.
When the function you want to assign is not displayed, turn **[DATA]** to scroll the display.

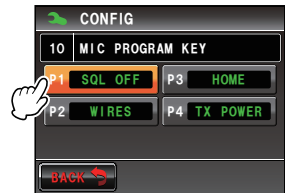

- Touch and select the function that you want to assign



- Touch **[BACK]**
The display will return to the selection screen for the program keys (P1 to P4).



7 Set other program keys

Repeat Steps 4 to 6 to set the functions to be assigned to other program keys.

8 Press  for one second or longer

The function will be assigned to the program key and the display will return to the previous screen.

Tip Factory default value: P1: SQL OFF (T-CALL: European version)

P2: HOME

P3: D_X

P4: TX POWER

Expanding the receive range

The frequency can be set to receive frequencies such in the air band (108 to 137 MHz) and the information wireless band (174 to 400 MHz, 480 to 999.99 MHz) as well.

1 Press  for one second or longer

The set-up menu will be displayed.

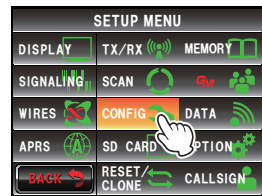
2 Touch **[CONFIG]****3** Touch **[11 RX COVERAGE]** to set the receive range

The setting switches between “NORMAL” and “WIDE” each time it is touched.

NORMAL: Receives only the 144 MHz and the 430 MHz bands.

WIDE: Receives the air band and the information wireless band as well.

Tip Factory default value: NORMAL

4 Press  for one second or longer

The receive range will be set and the display will return to the previous screen.



Setting the unit display

The unit to be used when displaying the altitude, distance and speed can be set.

- 1 Press  for one second or longer
The set-up menu will be displayed.
- 2 Touch **[CONFIG]**

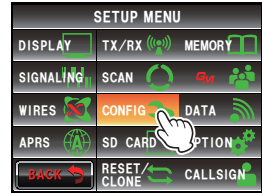

- 3 Touch **[12 UNIT]** to set the unit
The setting switches between “METRIC” and “INCH” each time it is touched.



METRIC: Displays the unit using the metric system.

INCH: Displays the unit using the inch system.

Tip Factory default value: Depends on the transceiver version

- 4 Press  for one second or longer
The display unit will be set and the display will return to the previous screen.

Switching the power off automatically

The radio can be set to switch the power off automatically when there is no operation for a period of time.

Refer to “Using the APO function” (P.123) for details.

Limiting the continuous transmission time

The radio can be set to return to the reception mode automatically after a time specified in advance has passed in the transmit mode.

Refer to “Using the TOT function” (P.124) for details.

Setting the PIN code of the optional Bluetooth headset

The headset that you are using can be paired with the optional Bluetooth unit mounted in the radio.

Refer to “Identifying the Bluetooth headset” (P.141) for details.

Setting the geodetic reference system of the GPS function

The geodetic reference system which serves as the positioning standard of the GPS function can be set.

- 1 Press **[DISP
MENU]** for one second or longer
The set-up menu will be displayed.
- 2 Touch **[CONFIG]**

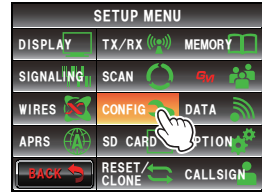

- 3 Touch **[16 GPS DATUM]** to set the geodetic reference system

The setting switches between “WGS-84” and “TOKYO MEAN” each time it is touched.

WGS-84: Positions using the global geodetic reference system. This is being used as a standard all around the world.

TOKYO MEAN: Positions using the Japanese geodetic reference system. When positioning in Japan (Tokyo), the error can be made smaller.

Tip Factory default value: WGS-84

- 4 Press **[DISP
MENU]** for one second or longer

The geodetic reference system of the GPS function will be set and the display will return to the previous screen.



Positioning using the external GPS device

This is set when connecting an external GPS reception device.

Refer to “Positioning using an external GPS device” (P.88) for details.

Setting the interval for recording the GPS position information

The time interval for recording your own position information in the micro-SD card can be set.

Refer to “Recording the position information (GPS log function)” (P.93) for details.

Data communication settings

Setting the COM port

The communication speed and function when using the [DATA] jack at the back of the main body as a COM port can be set.

- 1 Press **[DISP/GRAPH]** for one second or longer
The set-up menu will be displayed.
- 2 Touch **[DATA]**

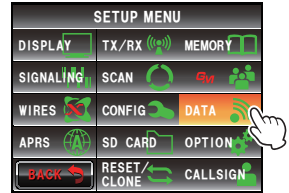

- 3 Touch **[1 COM PORT SETTING]**

The screen for the detailed settings will be displayed.

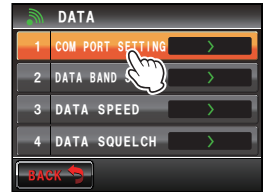

- 4 Touch **[SPEED]** to select the communication speed of the COM port

The setting changes as follows each time it is touched.

“4800 bps” → “9600 bps” → “19200 bps” →
“38400 bps” → “57600 bps”

Tip Factory default value: 9600 bps

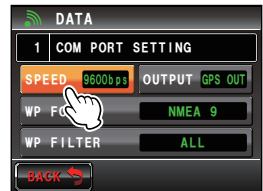

- 5** Touch **[OUTPUT]** to select the output function of the COM port

The setting changes as follows each time it is touched.

“OFF(camera)” → “GPS OUT” → “PACKET” → “WAYPOINT”

OFF (camera): The output function of the COM port is not used (invalid operation).

GPS OUT: Outputs the GPS data obtained by the radio.

PACKET: Outputs the AX.25 packet communication data received using the in-built modem function.

WAYPOINT: Outputs the position information of other station beacons obtained from the APRS packets received as WAYPOINT data.

Tip Factory default value: OFF (camera)

- 6** Touch **[WP FORMAT]** to select the data format

This sets the number of digits in the call sign information of the APRS beacon station appended to each data when “WAYPOINT” is selected in Step 5 (the data will be output using the NMEA-0183 \$GPWPL format).

The setting changes as follows each time it is touched.

“NMEA 9” → “NMEA 8” → “NMEA 7” → “NMEA 6”

NMEA 9: The call sign will be limited to 9 digits on the right (Example: The call sign information for JQ1YBG-14 is “JQ1YBG-14”).

NMEA 8: The call sign will be limited to 8 digits on the right (Example: The call sign information for JQ1YBG-14 is “Q1YBG-14”).

NMEA 7: The call sign will be limited to 7 digits on the right (Example: The call sign information for JQ1YBG-14 is “1YBG-14”).

NMEA 6: The call sign will be limited to 6 digits on the right (Example: The call sign information for JQ1YBG-14 is “YBG-14”).

Tip Factory default value: NMEA 9

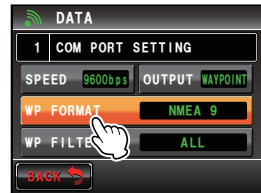
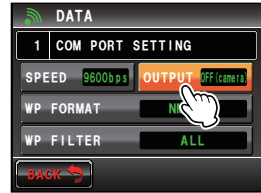

7 Touch **[WP FILTER]** to select the forwarding content

This sets the type of beacon that you would like to output when “WAYPOINT” is selected in Step 5.

The setting changes as follows each time it is touched.

“ALL” → “MOBILE” → “FREQUENCY” → “OBJECT/ITEM” → “DIGIPEATER” → “VoIP” → “WEATHER” → “YAESU” → “CALL RINGER” → “RNG RINGER”

ALL: Outputs all beacons received.

MOBILE: Outputs only mobile stations.

FREQUENCY: Outputs only the stations with frequency information.

OBJECT/ITEM: Outputs only the object station or item station.

DIGIPEATER: Outputs only the digital repeater station.

VoIP: Outputs only VoIP stations such as WIRES.

WEATHER: Outputs only the weather station.

YAESU: Outputs only stations which are using Yaesu transceivers.

CALL RINGER: Outputs only the information of the call sign ringer station set using **[10 APRS RINGER (CALL)]** in the APRS set-up menu.

RNG RINGER: Outputs only the information of the station deemed to be the approaching station using the **[9 APRS RINGER]** range ringer function in the APRS set-up menu.

Tip Factory default value: ALL

8 Press **[DISP/GRAPH]** for one second or longer

The COM port will be set and the display will return to the previous screen.

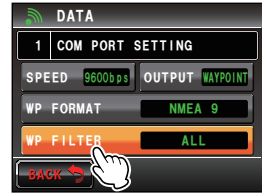

Setting the operating band of the APRS and data communication

The operating band of the APRS (internal modem) and data communication (when using the [DATA] jack at the back of the main body) can be set.

- 1 Press **[DISP/STATUS]** for one second or longer
The set-up menu will be displayed.
- 2 Touch **[DATA]**

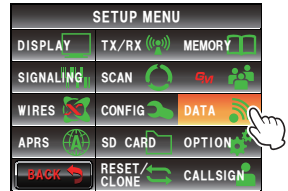

- 3 Touch **[2 DATA BAND SELECT]**
The screen for the detailed settings will be displayed.

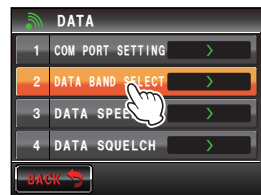

- 4 Touch **[APRS]** to select the APRS operating band
The setting changes as follows each time it is touched.

“A-BAND FIX” → “B-BAND FIX” → “A=TX/B=RX” →
“A=RX/B=TX” → “MAIN BAND” → “SUB BAND”

A-BAND FIX: The upper band will be selected.

B-BAND FIX: The lower band will be selected.

A=TX/B=RX: Transmits using the upper band and receives using the lower band.

A=RX/B=TX: Receives using the upper band and transmits using the lower band.

MAIN BAND: The main band will be selected.

SUB BAND: The sub-band will be selected.

Tip Factory default value: B-BAND FIX

- 5 Touch **[DATA]** to select the data transmission operating band
Repeat Step 4 to set the data communication operating band.

Tip Factory default value: B-BAND FIX

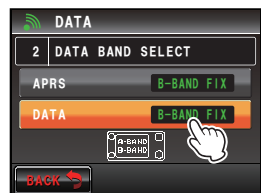
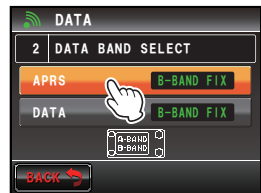

Using the Set-up Menu

- 6 Press  for one second or longer

The operating band of the APRS and data communication will be set and the display will return to the previous screen.

Setting the baud rate of the APRS and data communication

The baud rate of the APRS (internal modem) and data communication (when using the [DATA] jack at the back of the main body) can be set.

- 1 Press  for one second or longer
The set-up menu will be displayed.

- 2 Touch [DATA]

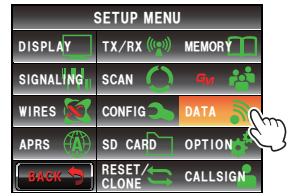

- 3 Touch [3 DATA SPEED]

The screen for the detailed settings will be displayed.

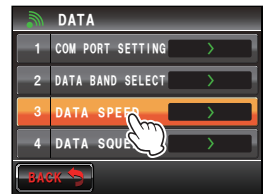

- 4 Touch [APRS] to select the packet communication speed

The setting will switch between “1200 bps” and “9600 bps” each time it is touched.

1200 bps: Sets the speed as AFSK 1200 bps packet.

9600 bps: Sets the speed as GMSK 9600 bps packet.

Tip Factory default value: 1200 bps

- 5 Touch [DATA] to select the data communication speed

Repeat Step 4 to set the data communication speed.

Tip Factory default value: 1200 bps

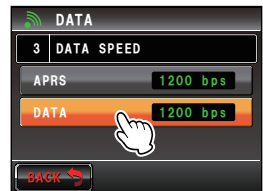
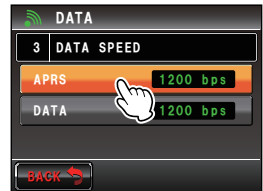

- 6 Press  for one second or longer

The baud rate of the APRS and data communication will be set and the display will return to the previous screen.

Setting the output condition of the squelch detection and squelch terminal

The squelch detection condition during APRS (internal modem) operation and squelch terminal output condition of the data APRS (when using the [DATA] jack at the back of the main body) can be set.

- 1 Press **[DISP/STAND]** for one second or longer
The set-up menu will be displayed.
- 2 Touch **[DATA]**

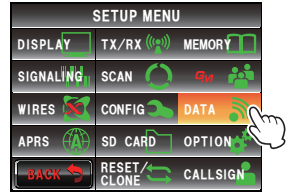

- 3 Touch **[4 DATA SQUELCH]**
The screen for the detailed settings will be displayed.

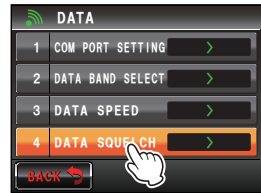

- 4 Touch **[APRS]** to select the squelch detection condition during APRS operation using the internal modem

The setting switches between “RX BAND” and “TX/RX BAND” each time it is touched.

RX BAND: Transmission is not possible when the receive band squelch is open.

TX/RX BAND: Transmission is not possible when either the receive band or transmit band squelch is open.

Tip Factory default value: RX BAND

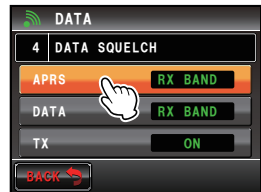

- 5 Touch **[DATA]** to select the output condition (during reception) related to the squelch terminal inside the [DATA] jack

The setting switches between “RX BAND” and “TX/RX BAND” each time it is touched.

RX BAND: The SQL terminal becomes active when the receive band squelch is open.

TX/RX BAND: The SQL terminal becomes active when either the receive band or transmit band squelch is open.

Tip Factory default value: RX BAND

- 6 Touch **[TX]** to select the output condition (during transmission) related to the squelch terminal inside the [DATA] jack

Each time this is touched, the setting will switch between “ON” and “OFF”.

ON: The SQL terminal becomes active during transmission.

OFF: The SQL terminal does not become active during transmission.

- The action to be taken when the reception band specified using **[DATA]** under **[2 DATA BAND SELECT]** in the DATA set-up menu is ready to transmit is set here.
- When this is set to ON, transmission of external devices such as TNC can be suppressed during transmission.

Tip Factory default value: ON

- 7 Press **[DUAL BAND]** for one second or longer

The APRS and data communication squelch will be set and the display will return to the previous screen.

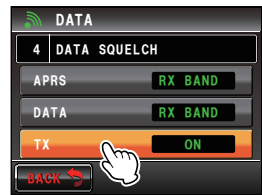
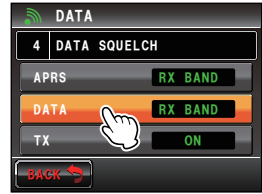

APRS function settings

The APRS function of the radio is a data communication system for data such as messages and station position using the APRS format.

Refer to the separate Operating Manual APRS Edition for details (download the manual from the YAESU website).

Micro-SD card settings

Writing settings to the micro-SD card

Using a micro-SD card, the memory channels registered in the radio and the settings in the set-up menu can be copied to another FTM-400XDR/DE.

The settings saved in the micro-SD card can also be downloaded into the radio. Refer to “Copying the Radio Data to another transceiver” (P.155) for details.

Writing group IDs to the micro-SD card

The group ID information registered in the radio can be written to a micro-SD card.

The group ID information saved in the micro-SD card can also be downloaded into the radio.

Refer to the separate Operating Manual GM Edition for further details (download the operating manual from the YAESU website).

Initializing the micro-SD card

Initialize the memory card when using a new micro-SD card.

Refer to “Initializing the micro-SD card” (P.35) for details.

Optional device settings

Setting the image of the connected speaker microphone with camera

The image size and quality when taking pictures with the connected speaker microphone with a camera (MH-85A11U) can be set.

- 1 Press **[DISP/STAB]** for one second or longer
The set-up menu will be displayed.
- 2 Touch **[OPTION]**

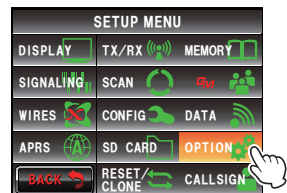

- 3 Touch **[1 USB CAMERA]**

The screen for setting the image will be displayed.

- PICTURE SIZE: Sets the size of the picture to be taken.
- PICTURE QUALITY: Sets the quality of the picture to be taken.



Using the Set-up Menu

4 Touch [PICTURE SIZE] to set the picture size

The setting changes between “160*120” and “320*240” each time it is touched.

- Tip**
- Factory default value: 320*240 (unit: pixel)
 - It takes about 30 seconds to sending a picture in the size of 320*240 to other transceivers.

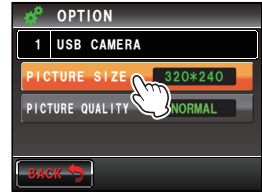

5 Touch [PICTURE QUALITY] to set the picture quality

The setting will change in the following order each time it is touched.

“LOW (low resolution)” → “NORMAL” → “HIGH (high resolution)”

- Tip** Factory default value: NORMAL

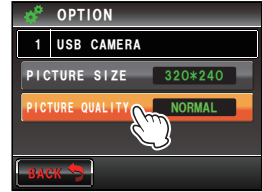

6 Press for one second or longer

The camera image will be set and the display will return to the previous screen.

Setting the operation of the Bluetooth headset

By mounting the Bluetooth unit to the radio and using a Bluetooth headset, audio can be received and sent wirelessly.

Refer to “Using the Bluetooth headset” (P.138) for details.

Setting the voice memory operation

By mounting the voice guide unit to the radio, audio that is received or picked up by the microphone can be recorded and then played back or erased later.

Refer to “Using the voice memory” (P.150) for details.

Initialization and saving settings

Reconfiguring the settings

The settings and memory of the radio can be returned to the default factory settings. Refer to “Reconfiguring the Settings” (P.61) for details.

Registering the preset

Current settings such as the frequency and memory channels can be registered in a single preset.

1 Press for one second or longer

The set-up menu will be displayed.

2 Touch [RESET/CLONE]

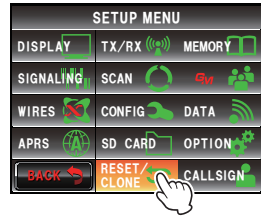

3 Touch [2 PRESET]

The screen for confirming the preset registration will be displayed.



4 Touch [OK?]

The preset will be registered.

When canceling the registration, touch [Cancel].



5 Press for one second or longer

The display will return to the previous screen.

Recalling the registered preset

The registered preset can be recalled from the set-up menu.

1 Press for one second or longer

The set-up menu will be displayed.

2 Touch [RESET/CLONE]

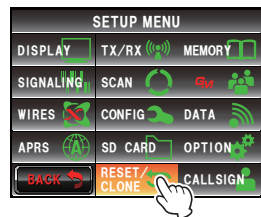

3 Touch [3 RECALL PRESET]

The screen for confirming the recall of the registered preset will be displayed.



Using the Set-up Menu

4 Touch [OK?]

The registered preset will be recalled and the display will return to the previous screen.

When canceling the recall, touch **[Cancel]**.



Sorting the registered memory channels

The memory channels registered in the radio can be sorted in the ascending order.

1 Press **[MSP/RECALL]** for one second or longer

The set-up menu will be displayed.

2 Touch **[RESET/CLONE]**

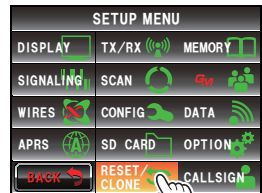

3 Touch **[5 MEM CH SORT]**

The screen for confirming the sorting of the memory channels will be displayed.

4 Touch **[OK?]**

The memory channels will be sorted starting from the lowest frequencies.

When canceling the sorting, touch **[Cancel]**.



5 The radio will start up again

The power will be switched off once and then it will be switched on automatically.



Copying saved data

All the data saved in the radio can be copied directly to another FTM-400XDR/DE. Refer to “Using the clone function” (P.157) for details.

Call sign settings

Changing the call sign

You can change your own call sign set in the radio.

- 1 Press **[DISP/STATUS]** for one second or longer
The set-up menu will be displayed.
- 2 Touch **[CALLSIGN]**
The current call sign will be displayed.

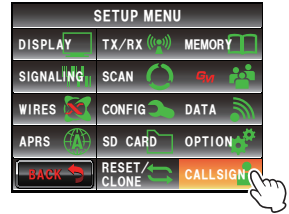

- 3 Touch **[CHANGE]**
The character input screen will be displayed.

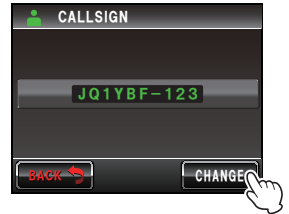

- 4 Touch a character key
The touched character will be displayed at the top of the screen.

- Tips**
- Up to 10 characters of alphabets, numerics, and a hyphen can be entered.
 - Refer to Page 23 on how to operate the character input screen.

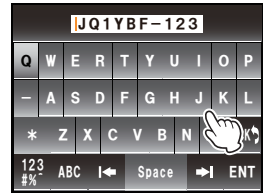

- 5 Touch **[ENT]**
The new call sign will be displayed.

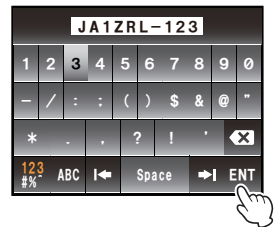

- 6 Touch **[BACK]**
- 7 Press **[DISP/STATUS]** for one second or longer
The call sign will be set and the display will return to the previous screen.



Options List

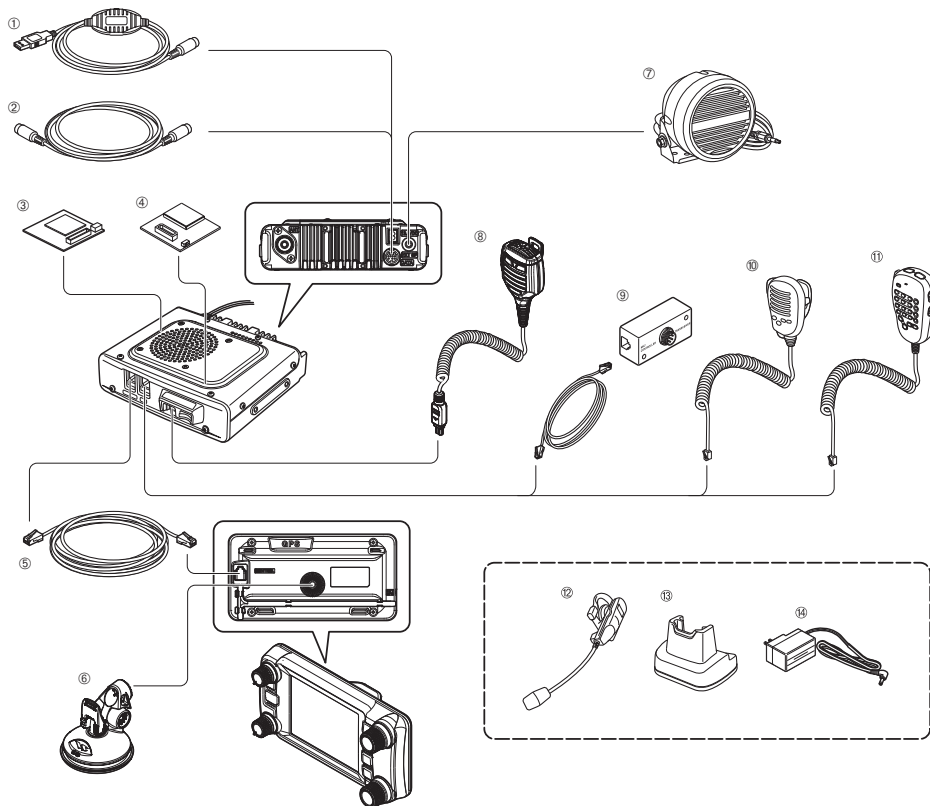

① PC connection cable (SCU-20)

*Same as the one provided

② Cloning cable (CT-166)

③ Voice guide unit (FVS-2)

④ Bluetooth unit (BU-2)

⑤ Control cable (CT-162)

⑥ Controller bracket (MMB-98)

⑦ Water proof (equivalent to IP55) high power external speaker (MLS-200-M10)

⑧ Speaker microphone with camera (MH-85A11U)

⑨ Microphone extension kit (MEK-2)

⑩ Hand Microphone (MH-42C6J)

⑪ DTMF Microphone (MH-48A6JA)

*Same as the one provided

⑫ Water proof Bluetooth headset (monaural) (BH-2A)

⑬ Charging cradle for BH-2A (CD-40)

⑭ Battery charger for CD-40 (PA-46)

● Data cable (CT-163): DIN 10 pin ↔ DIN 6 pin + Dsub 9 pin

● Data cable (CT-164): DIN 10 pin ↔ DIN 6 pin

● Data cable (CT-165): DIN 10 pin ↔ Dsub 9 pin

● Data cable (CT-167): DIN 10 pin ↔ Split end (10 pin)

Care and maintenance

Turn the transceiver OFF before wiping away any dust and stains on the radio using a dry and soft cloth. For stubborn stains, slightly moisten a soft cloth and wring it hard before using it to wipe away the stains.

Caution Never use washing detergents and organic solvents (thinner, benzene etc.). This may result in the paint peeling off or the cover being damaged.

Replacing the fuse

Use ONLY the correct rating (15 A) replacement fuse in the DC cable fuse holder.

Caution When replacing the fuse, disconnect the power supply cable from the radio and from the external DC power supply.

● Replacing the fuse of the DC power supply cable

1 Prepare a new fuse

Use a fuse with a rating of 15 A.

Caution Never use a fuse that is not of the specified rating.

2 Open the fuse holder as shown in the diagram on the right

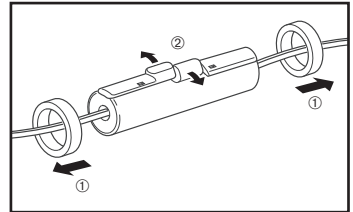

3 Remove the broken fuse

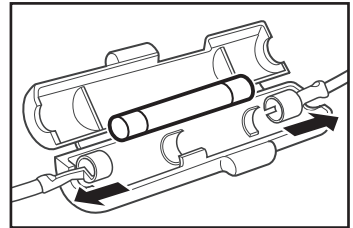

4 Attach the new fuse

5 Close the fuse holder

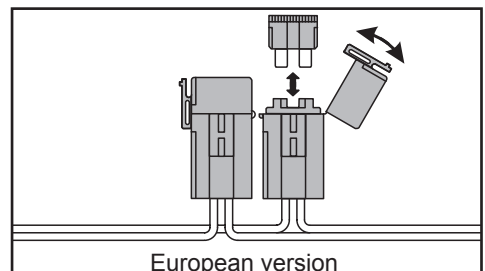

When you have difficulties ...

Caution

Check the following before requesting for repair services.

There is no power

- Is the external power supply connected correctly?
Connect the black wire to the negative (-) terminal and the red wire to the positive (+) terminal.
- Is the voltage and current capacity of the external power supply sufficient?
Check the voltage (13.8 V) and current capacity (20 A or above) of the external power supply.
- Is the fuse broken?
Replace the fuse.

There is no sound

- Is the squelch level or setting too high?
Adjust the squelch level when receiving weak signals.
- Is the volume low?
Increase the volume by turning the VOL knob in a clockwise direction.
- Is the tone squelch or DCS turned on?
When the tone squelch or DCS is turned on, no sound will be heard until signals containing the same tone frequency, or DCS code that have been set are received.
- Is the external speaker connected?
Connect a speaker with an impedance of 4 to 16 Ω correctly.
- Is the Bluetooth headset in use?
Disable the use of the headset or use the set-up menu to allow sound to come from both the headset and the main body speaker.

There is no transmission

- Is the PTT switch pressed properly?
- Is the microphone connected correctly?
Plug the connector all the way into the MIC jack.
- Is the transmission frequency set to the amateur band?
Transmission outside the amateur band is not possible.
- Is the antenna or co-axial cable broken?
Replace the antenna or co-axial cable.
- Is the voltage of the external power supply normal?
When the voltage of the power supply drops during transmit, the transceiver may not work properly.
Use a stable DC power supply with a voltage of 13.8 V and a current capacity of 20 A.

The keys or knobs will not operate

- Is the lock function activated?
Cancel the lock by pressing the POWER / LOCK key.

About internal spurious signals

Certain frequency combinations of signals received simultaneously, may cause some effect on the receiver mixer and IF circuits due to the high frequency of the internal oscillator.

However, this is not a malfunction (refer to the calculation formulas below: n is any integer).

Depending on the combination of the frequencies received at the same time, there may also be fluctuations in the receiver sensitivity

- Reception frequency = 12.288 MHz x n times
- Reception frequency = 2.4576 MHz x n times
- Reception frequency = 11.1 MHz x n times
- Upper (Band A) frequency = (Lower (Band B) frequency \pm 44.85 MHz) \times n times
- Lower (Band B) frequency = (Upper (Band A) frequency \pm 47.25 MHz) \times n times @ Upper band (Band A) MODE = NFM
- Reception frequency = 15.6 MHz x n times
- Reception frequency = 6.1444 MHz x n times
- Reception frequency = 18.432 MHz x n times

After-market Services

○ The warranty period is 1 year or 2 years from the date of purchase

The warranty certification is enclosed with the product. Breakdowns arising from normal use of the product in accordance with the instructions in the operating manual shall be repaired free-of-charge within a period of 1 year (USA, EXP version) or 2 years (European Version) from the date of purchase.

○ Keep the warranty certificate in a safe location

When the warranty certificate is lost, failures which occur during the warranty period will be treated as chargeable non-warranty claims.

A warranty certificate where necessary information such as the purchase date and the name of the retail store have not been filled in will also be treated as void. Please ensure that the date of purchase and the name of the retail store are filled in correctly in the warranty certificate.

○ You may also check with us for any non-warranty repairs

We will repair at your expense if the functions can be maintained after the repair. Please check with the retail store or Yaesu customer support for more information.

○ Keep the packaging box

When transporting this product for inspection and repair, use the original product packaging box to prevent accidents and damages during the transport.

Specification

● General

Frequency range	: TX 144 - 146 MHz or 144 - 148 MHz 430 - 440 MHz or 430 - 450 MHz
	: RX 108 - 137 MHz (Air Band) 137 - 174 MHz (144 MHz HAM) 174 - 400 MHz (GEN1) 400 - 480 MHz (430 MHz HAM) 480 - 999.99 MHz (GEN2)
Channel steps	: 5/6.25/8.33/10/12.5/15/20/25/50/100 kHz (8.33 kHz : only for Air band)
Emission Type	: F1D, F2D, F3E, F7W
Frequency stability	: ± 2.5 ppm -4°F to $+140^{\circ}\text{F}$ (-20°C to $+60^{\circ}\text{C}$)
Antenna impedance	: 50 Ω
Supply Voltage	: Nominal 13.8 V DC, negative ground
Current consumption	: 0.5 A (receive) 11 A (50 W TX, 144 MHz) 12 A (50 W TX, 430 MHz)
Operating temperature	: -4°F to $+140^{\circ}\text{F}$ (-20°C to $+60^{\circ}\text{C}$)
Case size	: Radio unit: 5.5" (W) \times 1.6" (H) \times 4.9" (D) (140 \times 40 \times 125 mm) w/o fan Controller: 5.5" (W) \times 2.8" (H) \times 0.8" (D) (140 \times 72 \times 20 mm)
Weight (approx.)	: 2.64 lbs (1.2 kg) with radio unit, controller, control cable

● Transmitter

RF power output	: 50/20/5 W
Modulation type	: F1D, F2D, F3E : Variable Reactance Modulation F7W : 4FSK (C4FM)
Spurious emission	: At least 60 dB below
Microphone impedance	: About 2 k Ω
DATA terminal input impedance	: About 10 k Ω

● Receiver

Circuit type	: Double conversion super-heterodyne	
Intermediate frequencies	: A band: 1st : 47.25 MHz, 2nd :450 kHz B band: 1st : 44.85 MHz, 2nd : 450 kHz	
Receiver Sensitivity	: 108 - 137 MHz (AM) 137 - 140 MHz (FM) 140 - 150MHz (FM) 150 - 174 MHz (FM) 174 - 222 MHz (FM) 222 - 300 MHz (FM) 300 - 336 MHz (AM) 336 - 420 MHz (FM) 420 - 470 MHz (FM) 470 - 520 MHz (FM) 800 - 900 MHz (FM) 900 - 999.99 MHz (FM)	: 0.8 μ V typ for 10 dB SN 0.2 μ V for 12 dB SINAD 0.2 μ V for 12 dB SINAD 0.25 μ V for 12 dB SINAD 0.3 μ V typ for 12 dB SINAD 0.25 μ V typ for 12 dB SINAD 0.8 μ V typ for 10 dB SINAD 0.25 μ V for 12 dB SINAD 0.2 μ V typ for 12 dB SINAD 0.2 μ V for 12 dB SINAD 0.4 μ V typ for 12 dB SINAD 0.8 μ V typ for 12 dB SINAD Cellular blocked (USA only)
	Digital mode	
	140 - 150 MHz (Digital)	0.19 μ V typ for BER 1%
	420 - 470 MHz (Digital)	0.19 μ V typ for BER 1%
Squelch sensitivity	: 0.16 μ V (144/430 MHz)	
Selectivity	: AM, FM 12 kHz/35 kHz (-6 dB/-60 dB)	
AF output	: 3 W (8 Ω , THD10%, 13.8 V) internal speaker 8 W (4 Ω , THD10%, 13.8 V) Optional MLS-200-M10	
AF output impedance	: 4 - 16 Ω	
Strength of secondary radio waves:	4 nW and below	

Cautions

- Rated values are at normal temperature and pressure.
- Ratings and specifications are subject to change without notice.

● Symbols placed on the equipment

== Direct current

A

About internal spurious signals 211
 accessories 13
 after-market services 211
 alphabet input screen 23
 altitude
 measuring 94
 altitude changes
 erasing 95
 altitude display screen 21
 AMS 45, 46
 AMS transmission mode 178
 analog FM mode 46
 announce function
 setting operation 153
 antenna 25
 connecting 29
 install 25
 ANT terminal 16
 APO function 123
 APRS
 baud rate 200
 operating band 199
 APRS function 102
 APRS function settings 202
 ARS 52
 audio
 erasing the recorded one 152
 muting 48
 recording and listening to 148
 recording the received one 151
 replaying the recorded one 151
 auto repeater shift 189

B

background color of the frequency
 display area 60
 backtrack function 97, 99
 band scope 47
 band scope display width 176
 band scope screen 19
 beep volume 54, 191
 Bluetooth headset 138
 identifying 141
 operation 204
 setting the operation 140
 using 143
 Bluetooth unit
 mounting 138

C

call sign 37
 changing 207
 call sign settings 207
 car battery 30

checking the route using a personal
 computer 94
 clock shift of the CPU 191
 clone function 157
 communicating 49
 communicating with specified partner
 stations 106
 communication mode 45
 compass panel
 changing the direction 98
 compass screen 20, 97, 176
 COM port 196
 connecting the power supply 30
 connecting the radio 29
 connecting to a personal computer 159
 CONTROL jack 15, 16
 controller 14
 connecting to the main body 29
 installing 28
 copying saved data 206
 Copying the Radio Data to another
 Transceiver 155
 copyrights 4
 countdown timer 121
 count down timer screen 22
 CTCSS 106
 current location
 registering 99
 Customize Menu Settings and User
 Preferences 167

D

data communication
 baud rate 200
 operating band 199
 data communication settings 196
 DATA jack 16, 159
 date and time 56, 186
 display format 187
 DCS 108
 using 109
 DCS code 182
 setting 108
 DCS transmission 115
 DCS transmission / tone reception 115
 departure point
 registering 99
 DG-ID 62
 DIAL knob 14, 15
 Band A 14
 Band B 15
 digital code squelch 108
 Digital Group ID (DG-ID) feature 62
 Digital Personal ID (DP-ID) feature 64
 display background color 176
 display brightness 58, 177

display contrast	177
display method for my position.....	180
display mode	20
DISP/SETUP key	14
distance scale.....	95
DP-ID.....	64
DTMF	116
DTMF code	
registering	116, 182
transmission method	182
transmitting	
manually.....	118
registered code	117
DTMF function.....	116
dual band screen.....	19
dual receive.....	85
restart condition.....	86
DWN.....	17
D/X key.....	14

E

external device connected.....	159
external power supply equipment.....	32
external speaker.....	166
EXT GPS jack	15, 88
EXT SP jack	16, 166

F

FM mode	51
F/MW key	15
frequency step.....	191
frequency steps.....	41
FR mode.....	46
function menu screen.....	19
functions and configuration settings.....	186
fuse	
replacing.....	209

G

gain.....	50
geodetic reference system	96, 195
GM function	103
GM key.....	15
GPS.....	87
GPS function	87
GPS log function	93
GPS screen.....	23
group monitor function settings	186

H

home channel	
changing the frequency.....	68
monitoring	85
recalling.....	67

I

initialization and saving settings.....	204
inputting the character.....	23
installation location when used in a mobile unit.....	24
installing the radio	24
internal spurious intensity.....	211
interval for recording the GPS position information.....	195

L

lap timer.....	120
lap timer screen.....	22
latitude and longitude display screen	92
Listening to the frequency voice announcement.....	153
locking the knobs and switches.....	55

M

main body.....	16
installing	27
maintenance.....	209
memories to be skipped	81
memory	
erasing	69
naming	70
recalling	67
writing.....	66
memory channel.....	66
sorting	206
memory channel settings	182
memory mode	44
memory scan.....	78
memory scan method	182
memory tag	
display method	182
memory tag display	71
message	
creating and sending.....	129
downloading	128
forwarding	136
receiving.....	126
Registering standard messages.....	132
replying to.....	134
sending.....	126, 129
sorting	127
standard	131
viewing	126
MIC jack	16
microphone	
connecting.....	29
microphone (MH-48A6JA).....	17
micro-SD card	33
copying data from.....	156

copying data to.....	155
initializing.....	35
Initializing.....	203
installing.....	34
removing.....	34
setting up.....	33
writing group IDs to.....	203
writing settings to.....	203
micro-SD card settings.....	203
micro-SD card slot.....	16
modulation mode.....	46

N

Narrow Digital.....	47
Narrow FM mode.....	47
notification of an incoming call	
using the bell.....	114, 184
numbers and symbols input screen.....	23

O

operating band.....	38
operating mode.....	44
optional device settings.....	203
Optional receive Audio Record and	
Playback.....	148
options list.....	208
other stations	
registering the locations.....	100

P

packet communication.....	162
setting the operation.....	164
pager function.....	110
activating.....	112
pairing.....	141
partner station information	
pop-up time.....	180
picture	
downloading.....	128
forwarding.....	136
receiving.....	126
replying to.....	134
sending.....	126, 129
sending the saved one.....	133
sorting.....	127
taking.....	145
taking with the camera attached to the	
speaker microphone.....	144
viewing.....	126
viewing the saved one.....	147
PIN code.....	141, 194
PMS.....	83
PMS memory channel.....	83
position information.....	91

displaying the current.....	91
displaying the partner station.....	91
recording.....	93
position information display screen.....	176
position information screen.....	92
position information to the computer.....	160
positioning using GPS.....	87
positioning using the	
external GPS device.....	88, 195
position of the destination.....	101
power off.....	36
automatic.....	194
power supply/LOCK switch.....	14
preset	
recalling.....	205
registering.....	204
program key of the microphone.....	192
programmable key	
assigning the WX function to.....	75
programmable memory	
writing into.....	83
PTT.....	17

R

radio wave format.....	178
real-time navigation function.....	97, 98
recalling a specified station.....	112
receiving.....	36
reception range	
expanding.....	193
reconfiguring the settings.....	61, 204
registered trademarks.....	4
repeater.....	52
repeater shift	
direction.....	189
width.....	190
reset	
erasing only the registered memory	
channels.....	61
restoring all settings.....	61
restoring the APRS settings.....	61
reverse tone.....	114

S

satellite capture status.....	90
saving the destination.....	99
scanning direction.....	185
scanning function.....	76
scanning method.....	79
scanning stop.....	186
scanning the programmable	
memories.....	83, 84
scan only the specified memory channels	80
scan settings.....	185

- screen..... 18
 - screen display settings..... 175
 - Select the screen to be displayed 175
 - sensitivity of the microphone..... 50, 182
 - Setting the receive station code 110
 - set-up menu
 - basic operations 167
 - list..... 168
 - using..... 175
 - signal reception method 185
 - smart navigation function 97
 - snapshot function 144
 - speaker microphone with camera 203
 - connecting..... 144
 - specification..... 212
 - specified memories 79
 - specified stations
 - recalling..... 183
 - split memory 72
 - squelch detection 201
 - squelch level..... 39
 - squelch terminal 201
 - squelch type
 - setting for transmission and reception
 - separately..... 184
 - Standby Beep..... 180
 - stopwatch function..... 119
 - sub-band mute 181
- T**
- Taking Pictures with the optional Camera (Snapshot Function)..... 144
 - time display 177
 - timer / clock screen 119
 - timer/clock screen 21
 - timer function..... 119
 - time zone..... 96, 188
 - TNC 162
 - Tone Calling..... 53
 - tone frequency..... 182
 - setting..... 106
 - tone signal settings..... 182
 - tone squelch..... 106
 - using..... 107
 - tone transmission / DCS reception..... 115
 - TOT function..... 124
 - touch key..... 125
 - touch panel..... 4
 - touch panel display..... 14
 - transmission time
 - limiting 194
 - Transmit and receive settings 178
 - transmit power..... 50
 - transmitting..... 49
 - transmitting the tone signal 107
 - tuning the radio..... 40
 - turning the power on..... 36
- U**
- unit display 194
 - UP 17
 - updating the firmware of the radio..... 161
 - User Programmed Reverse CTCSS Decoder..... 114
 - user programmed reverse CTCSS tone... 183
- V**
- V/D mode 46
 - version of the DSP program..... 181
 - VFO mode 44
 - VFO scan 76
 - voice guide unit
 - mounting 148
 - voice memory..... 150
 - operation 204
 - setting the operation..... 150
 - VOL knob 14
 - voltage display..... 177
 - volume..... 38
 - VOX..... 138
- W**
- weather alert..... 75, 184
 - weather channels 74
 - recalling..... 75
 - When you have difficulties..... 210
 - WIRES-X Function 105
 - WX function..... 74

1. Changes or modifications to this device not expressly approved by YAESU MUSEN could void the user's authorization to operate this device.
2. This device complies with part 15 of the FCC Rules. Operation is subject to the following two conditions: (1) This device may not cause harmful interference, and (2) this device must accept any interference including received, interference that may cause undesired operation.
3. The scanning receiver in this equipment is incapable of tuning, or readily being altered, by the User to operate within the frequency bands allocated to the Domestic public Cellular Telecommunications Service in Part 22.

Part 15.21: Changes or modifications to this device not expressly approved by YAESU MUSEN could void the user's authorization to operate this device.

DECLARATION BY MANUFACTURER

The Scanner receiver is not a digital scanner and is incapable of being converted or modified to a digital scanner receiver by any user.

WARNING: MODIFICATION OF THIS DEVICE TO RECEIVE CELLULAR RADIOTELEPHONE SERVICE SIGNALS IS PROHIBITED UNDER FCC RULES AND FEDERAL LAW.

Disposal of your Electronic and Electric Equipment

Products with the symbol (crossed-out wheeled bin) cannot be disposed as household waste.

Electronic and Electric Equipment should be recycled at a facility capable of handling these items and their waste by products.

In EU countries, please contact your local equipment supplier representative or service center for information about the waste collection system in your country.



Attention in case of use

This transceiver works on frequencies which are not generally permitted.

As for the actual usage, the user has to possess an amateur radio licence.

Usage is allowed only in the frequency bands which are allocated for amateur radios.

List of national codes					
AT	BE	BG	CY	CZ	DE
DK	ES	EE	FI	FR	GB
GR	HR	HU	IE	IT	LT
LU	LV	MT	NL	PL	PT
RO	SK	SI	SE	CH	IS
LI	NO	-	-	-	-

Declaration of Conformity

Nr. YUK-DOC-0832-15

We, Yaesu UK Ltd. certify and declare under our sole responsibility that the following equipment complies with the essential requirements of the Directive 1999/5/EC and 2011/65/EU.

Type of Equipment	Dual Band Digital Transceiver
Brand Name	YAESU
Model Number	FTM-400DE / FTM-400XDE
Manufacturer	YAESU MUSEN Co. LTD
Address of Manufacturer	Tennozu Parkside Building 2-5-8 Higashi-Shinagawa, Shinagawa-ku, Tokyo 140-0002, JAPAN

Applicable Standards:

This equipment is tested to and conforms to the essential requirements of directive, as included in following standards:

Health 1999/5/EC Art. 3(1)(a)	EN 62311:2008
Safety 1999/5/EC Art. 3 (1) (a)	EN 60950-1:2006 + A2:2013
EMC 1999/5/EC Art. 3 (1) (b)	EN 301 489-01 V1.9.2 EN 301 489-15-V1.2.1
Radio Spectrum 1999/5/EC Art 3 (2)	EN 301 783-02 V1.2.1
RoHS2 2011/65/EU Art. 7 (b)	EN 50581:2012

The technical documentation as required by the Conformity Assessment procedures is kept at the following address:

Company: Yaesu UK Ltd
Address: Unit 12, Sun Valley Business Park, Winnall Close,
Winchester, Hampshire, UK, SO23 0LB

Technical Construction File: Issued by Yaesu Musen Co. Ltd., Tokyo, Japan
File No. YETA00320B

Drawn up in: Winchester, Hampshire UK
Date: 28th August 2015



Name and position: PCJ Bigwood,
Technical Sales Manager

YAESU

The radio

YAESU MUSEN CO., LTD.

Tennozu Parkside Building
2-5-8 Higashi-Shinagawa, Shinagawa-ku, Tokyo
140-0002 Japan

YAESU USA

6125 Phyllis Drive, Cypress, CA 90630, U.S.A.

YAESU UK

Unit 12, Sun Valley Business Park, Winnall Close
Winchester, Hampshire, SO23 0LB, U.K.

Copyright 2017

YAESU MUSEN CO., LTD.

All rights reserved.

No portion of this manual

may be reproduced

without the permission of

YAESU MUSEN CO., LTD.



1608U-EM-2

Printed in Japan



E H O 3 4 M 2 1 0